

2004 Delta Faucet Parts Catalog

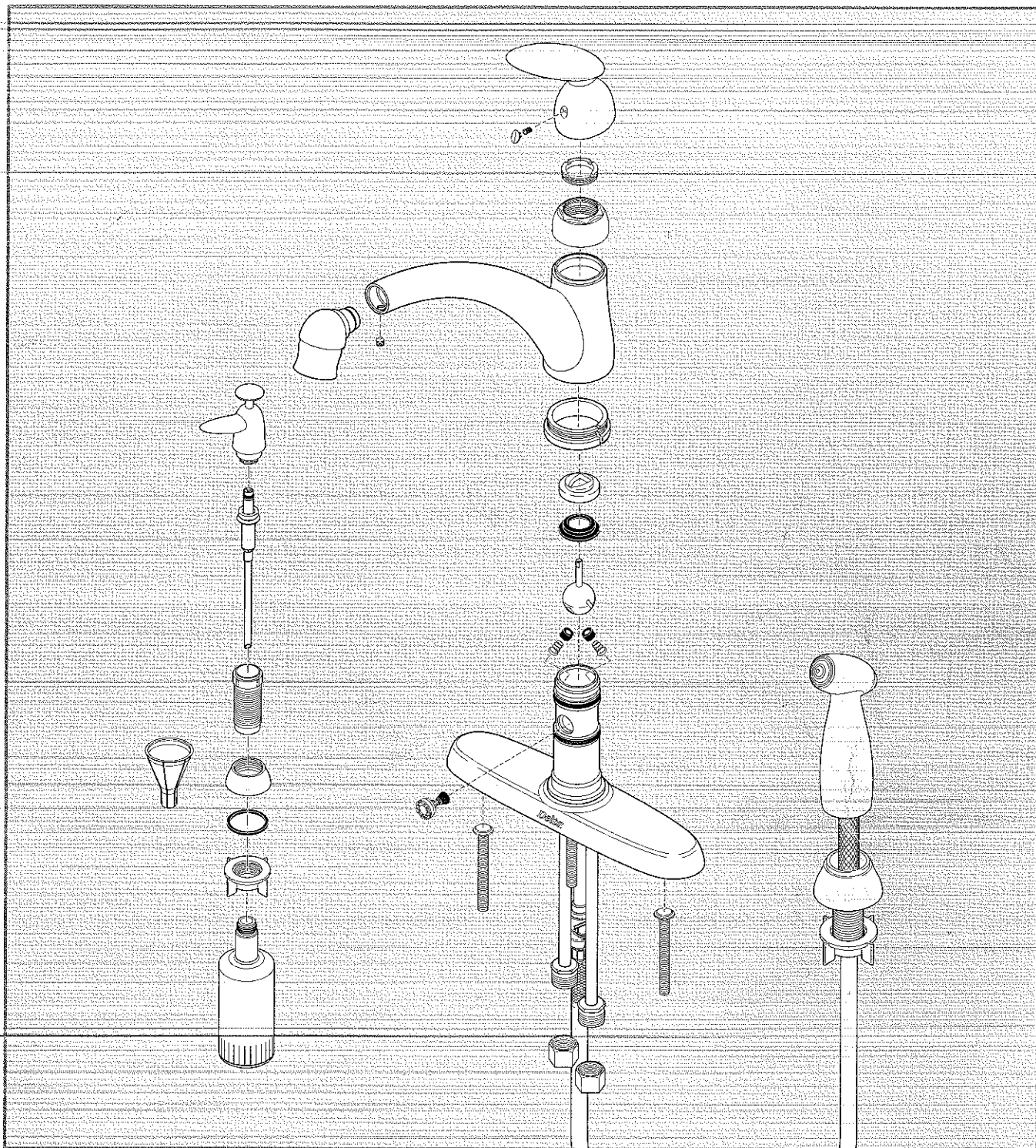

 **DELTA**[®]
FAUCET COMPANY

2004 Table of Contents

Index

1	Numerical Listing
Kitchen & Bar Faucets	
<i>Llaves para Fregaderos de Cocina y Llaves de Bares</i>	
2 - 23	Single Handle Kitchen
24 - 33	Two Handle Kitchen
34 - 35	Vegetable Sprayers / Additional Information
36 - 38	Single Handle Bar
39 - 43	Two Handle Bar
44	Kitchen/Bar Handles
45	Installation Aids & Repair Kits
Lavatory and Specialty Faucets	
<i>Llaves de Lavamanos y Llaves de Especialidad</i>	
46 - 56	Single Handle Lavatory
58 - 86	Two Handle Lavatory
88 - 95	Specialty Faucets
96	Lavatory/Specialty Handles
97	Installation Aids & Repair Kits
Lift Rods and Lavatory Drain Assemblies	
<i>Barras de Alzar y Desagües de la Baneras</i>	
98 - 99	Lift Rods
100-101	Lavatory Drain Assemblies
Tub/Shower Bath Valves	
<i>Válvulas para Bañeras</i>	
102	Single Handle Conventional 600 Series
103-106	Single Handle Monitor® 1300/1400 Series
107	Single Handle Monitor® 1500* Series
108	Single Handle 1600* Series
109-111	Single Handle Monitor® 1700 Series
112-116	Single Handle Monitor® 1800 Jetted Series
117	Two Handle Monitor® 2300* Series
118	Two Handle Conventional
119	Three Handle Conventional
120-122	Tub/Shower Handles
123	Installation Aids & Repair Kits
124-125	Showerheads, Arms, Flanges & Tub Spouts

Personal Hand Showers & Accessories

Regaderas de Mano Personal y Accesorios

126-127	Personal Hand Showers & Accessories
Roman Tub Faucets, Roman Tub Rough-In Kits & Hand Held Showers	
<i>Llaves para Bañeras Romanas, Equipo para Preparación de Instalación para Llaves de Bañeras Romanas y Regaderas de Mano para Llaves de Bañeras Romanas</i>	

128-143	Roman Tub Faucets
144-148	Roman Tub Rough-In Kits
150-151	Hand Held Showers
152	Roman Tub Handles
153	Hand Held Shower Handles
154	Installation Aids & Repair Kits

Bath Waste Assemblies

Ensamblés de Desagües de la Bañera

156	Trip Lever
157	Lift-N-Turn
158	Trip Lever
159-160	Toe Operated

Bidet Valves

Válvulas para Bides

162-163	Bidet Valves
164	Bidet Handles

Misc. Parts, Abbreviations & Suffixes

Abreviaciones y Sufijos

166-173	Miscellaneous Parts
174	Abbreviations & Suffixes

INDEX/INDICE

SERIES	PAGE/PÁGINA	SERIES	PAGE/PÁGINA	SERIES	PAGE/PÁGINA
33	162	611*	102	2683	119
44	163	612	102	2705	132
100	2	621	102	2708*	128
101	5	622	102	2710	129
110	2	635	102	2711	129
120	6	636	102	2714*	130
140	7	641	102	2715	131
141	9	642	102	2730	133
142*	7	750	90, 91	2731	133
150	10	752*	92	2750*	134
151*	11	1300	103	2755	135
155	13	1400	103	2756	135
156	13	1425	104	2760*	136
157	13	1427	105	2761*	136
158	13	1430	106	2765	137
172	14, 15	1447	105	2766	137
173*	14, 15	1455	104	2767	138
174	14, 15	1460	106	2768*	138
175	5	1480	106	2770	139
176*	14, 15	1500*	107	2771*	139
178*	14, 15	1600*	108	2780	140
180	17	1700	109	2781	140
181*	9	1725	110	2788	141
186	18	1728	111	2789	141
187	18	1755	110	2800	118
188	19	1768	111	2861	119
190	36, 37	1769	111	2871	119
198	38	1800	112-116	2882	119
200	16	2100	24	2885*	119
275*	16	2102	24	2897	119
300	4	2121	93	3504*	69
340	8	2123	93	3523*	69
342*	8	2131	94	3524*	69
350	12	2133	94	3530	70, 71
380	8	2140*	25	3543	72, 73
400	2	2147*	26, 27	3544	72, 73
400-D*	3	2155	39	3555	74
420	6	2167	28	3560*	75
440	7	2170	40	3565	75
441	9	2171	40	3567	76, 77
442*	7	2172	40	3577	78, 79
443*	9	2174	29	3583	80, 81
450	10	2176	29	3584*	80, 81
451	11	2177	41	3588	82
462*	20	2178	42	4530	83
466*	20	2179	42	4555	84
470	21	2180*	30	4577	85
472	21	2190	43	4588	86
473	22	2255	31	4756	142
473-SD	22	2256	31	4789	143
474	23	2274	32, 33	R1817	116
476	23	2276	32, 33	R1822	114
480	17	2300*	117	R1824	115
481	9	2302	95	R1842	114
488	19	2400	24	R1848	115
500	46	2402	24	R2707	144
501	46	2440*	25	R4707	145
502	48	2447	26, 27	RP291	156
503*	48	2467	28	RP293	160
504*	49	2474	29	RP391	158
505	47	2476	29	RP393	159
510*	46	2480*	30	RP691	156
520	46	2500	58	RP693	160
522	48	2502	58	RP695*	157
524	49	2520	58	RP14979	150
525	47	2521	58	RP18227	147
540	50	2522	58	RP18235	148
541	50	2530	59	RP23601	146
542	51	2555	60	RP32538	126
544	52	2560*	61	RP32539	126
547	56	2565	62	RP32540	127
550	53	2567	63	RP32541	126
552*	54	2577	64	RP33791	151
60*	88	2580	66	T1817	116
62	89	2583	65	T1824	112
670	55	2585	67	T1825	112
601	102	2588	68	T1837	116
602	102	2600	118	T1848	113
606*	102	2653	119	T1855	113

Single Handle Kitchen Faucets

Manija de Palanca para Fregaderos

Classic Series Models/Modelos 100, 110 & 400 Series

KITCHEN

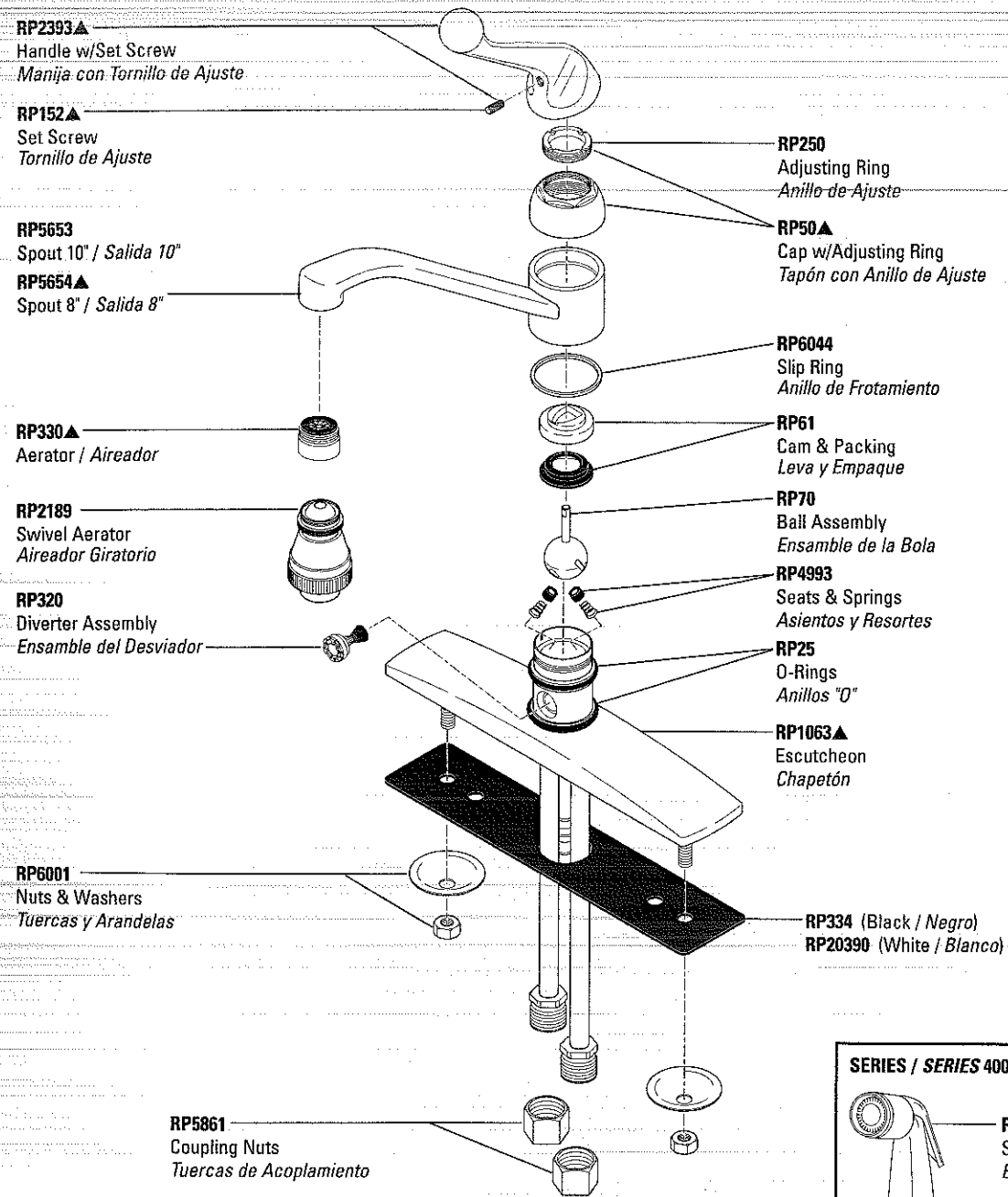

SERIES / SERIES 400 – Quick-Snap®

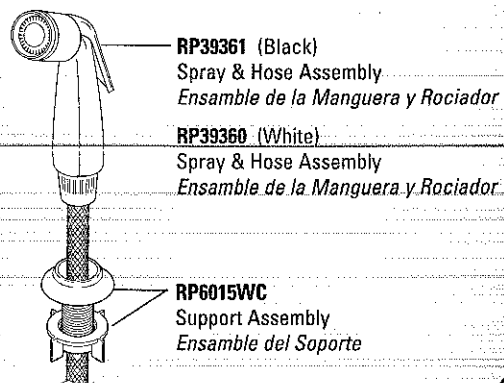

For non Quick-Snap® faucet models manufactured BEFORE September 2002, see page 34 for Vegetable Sprayers.

Para ver los modelos de llaves de agua sin Quick-Snap® fabricados ANTES de Septiembre 2002, vea la página 34 de Rociadores para Vegetales.

Thick tile mounting kit available as RP30393 allows installation up to 2 1/2" decks.
Las herramientas para la instalación en losas gruesas en el equipo RP30393 permiten la instalación en bordes hasta 2 1/2".

Single Handle Kitchen Faucets

Manija de Palanca para Fregaderos

Classic Series Model/Modelo 400-D* Series

KITCHEN

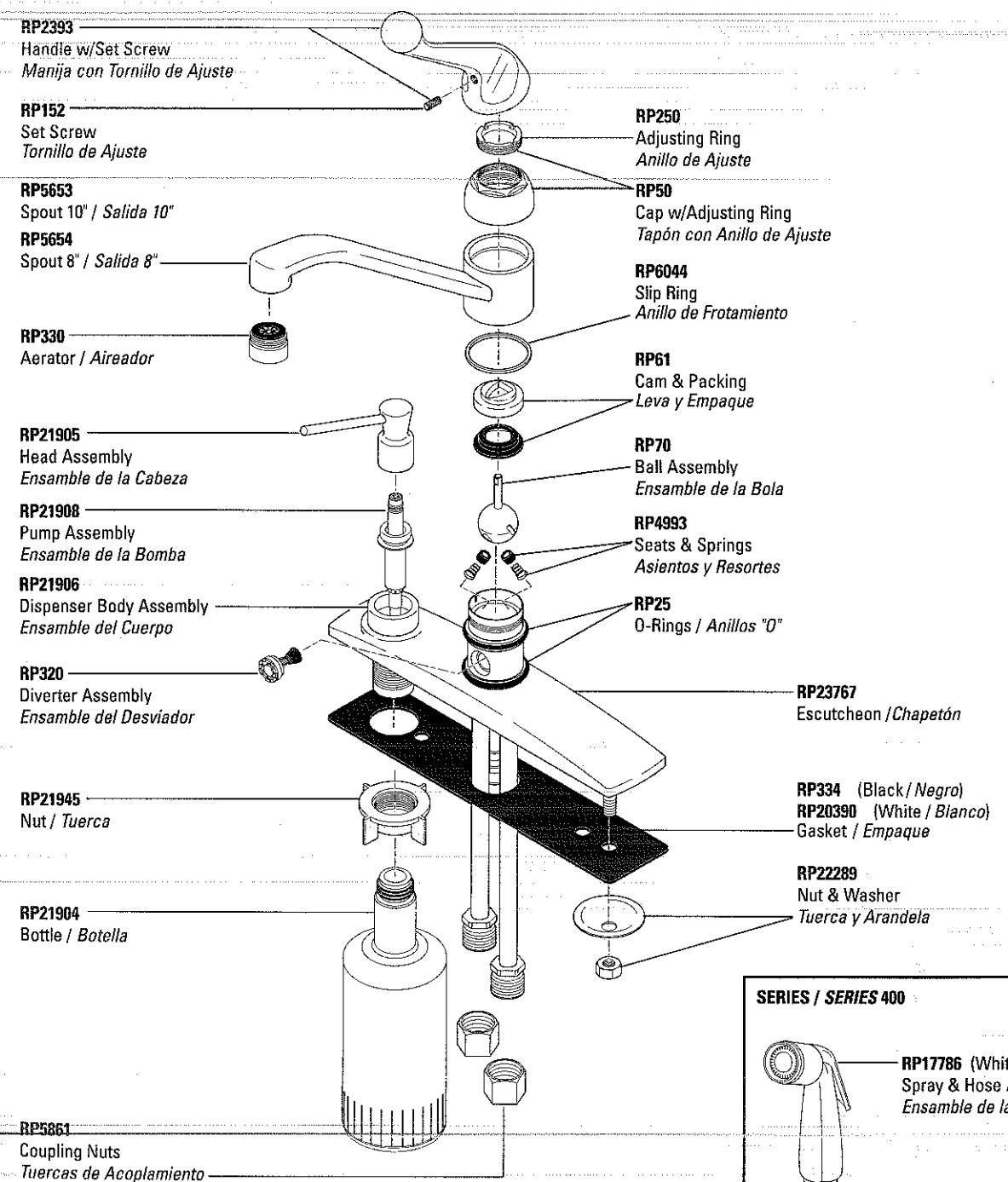

SERIES / SERIES 400

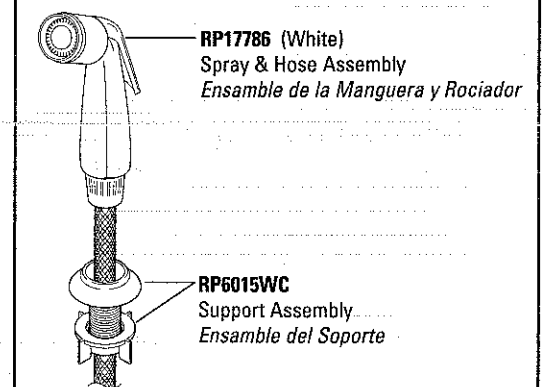

Thick tile mounting kit available as RP30393 allows installation up to 2 1/2" decks.
Las herramientas para la instalación en losas gruesas en el equipo RP30393 permiten la instalación en bordes hasta 2 1/2".

Single Handle Kitchen Faucets

Manija de Palanca para Fregaderos

Classic Series Model/Modelo 300 Series

KITCHEN

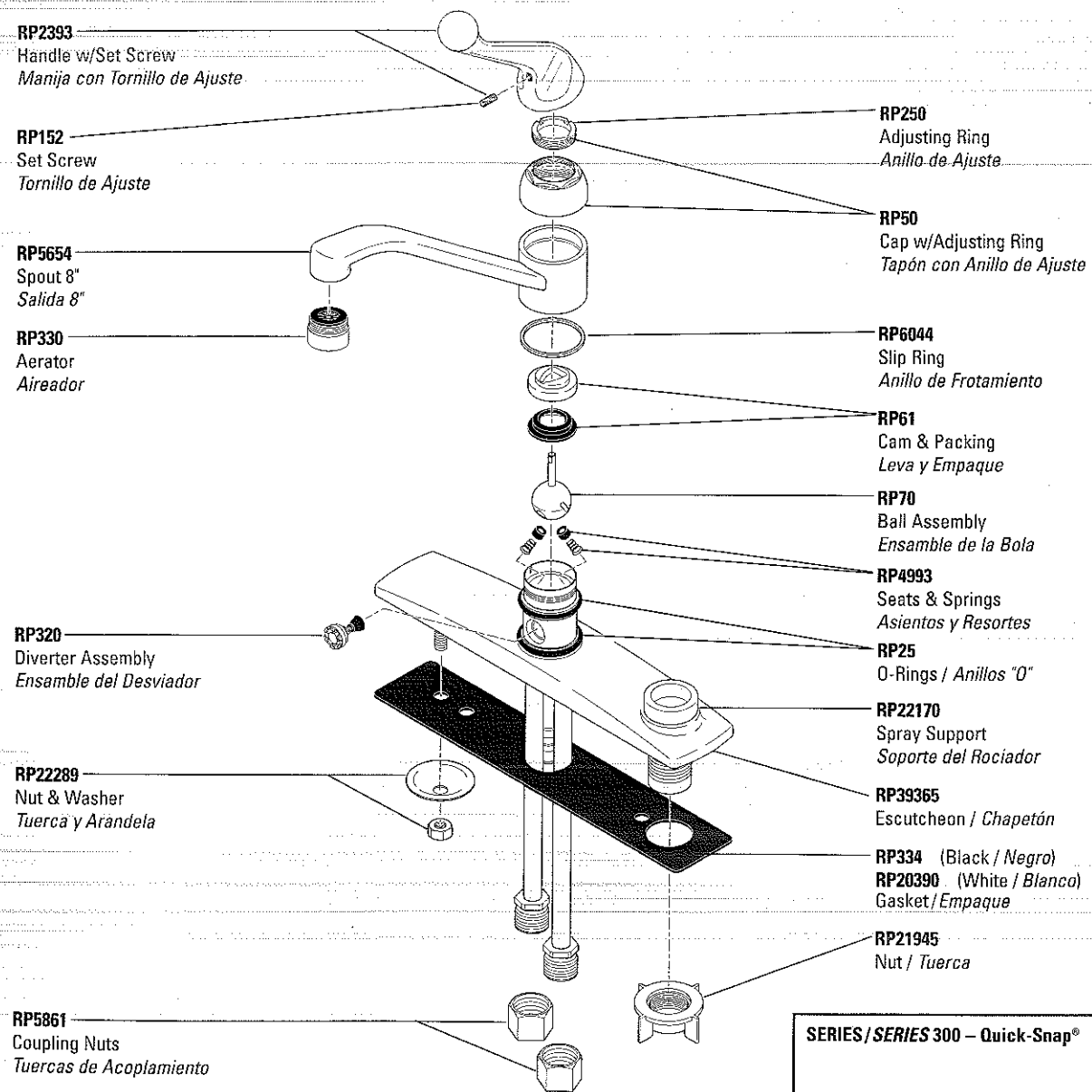

SERIES / SERIES 300 – Quick-Snap®

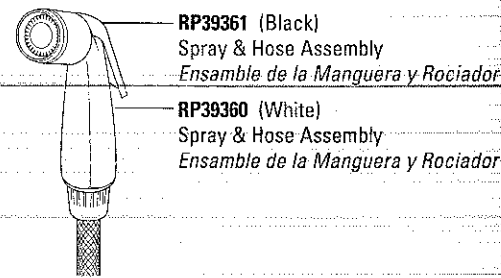

For non Quick-Snap® faucet models manufactured BEFORE September 2002, see page 34 for Vegetable Sprayers.

Para ver los modelos de llaves de agua sin Quick-Snap® fabricados ANTES de Septiembre 2002, vea la página 34 de Rociadores para Vegetales.

Thick tile mounting kit available as RP30393 & RP31845 allows installation up to 2 1/2" decks.
Las herramientas para la instalación en losas gruesas en el equipo RP30393 y RP31845 permiten la instalación en bordes hasta 2 1/2".

Single Handle Kitchen Faucets

Manija de Palanca para Fregaderos

Classic Series Models/Modelos 101 & 175 Series

KITCHEN

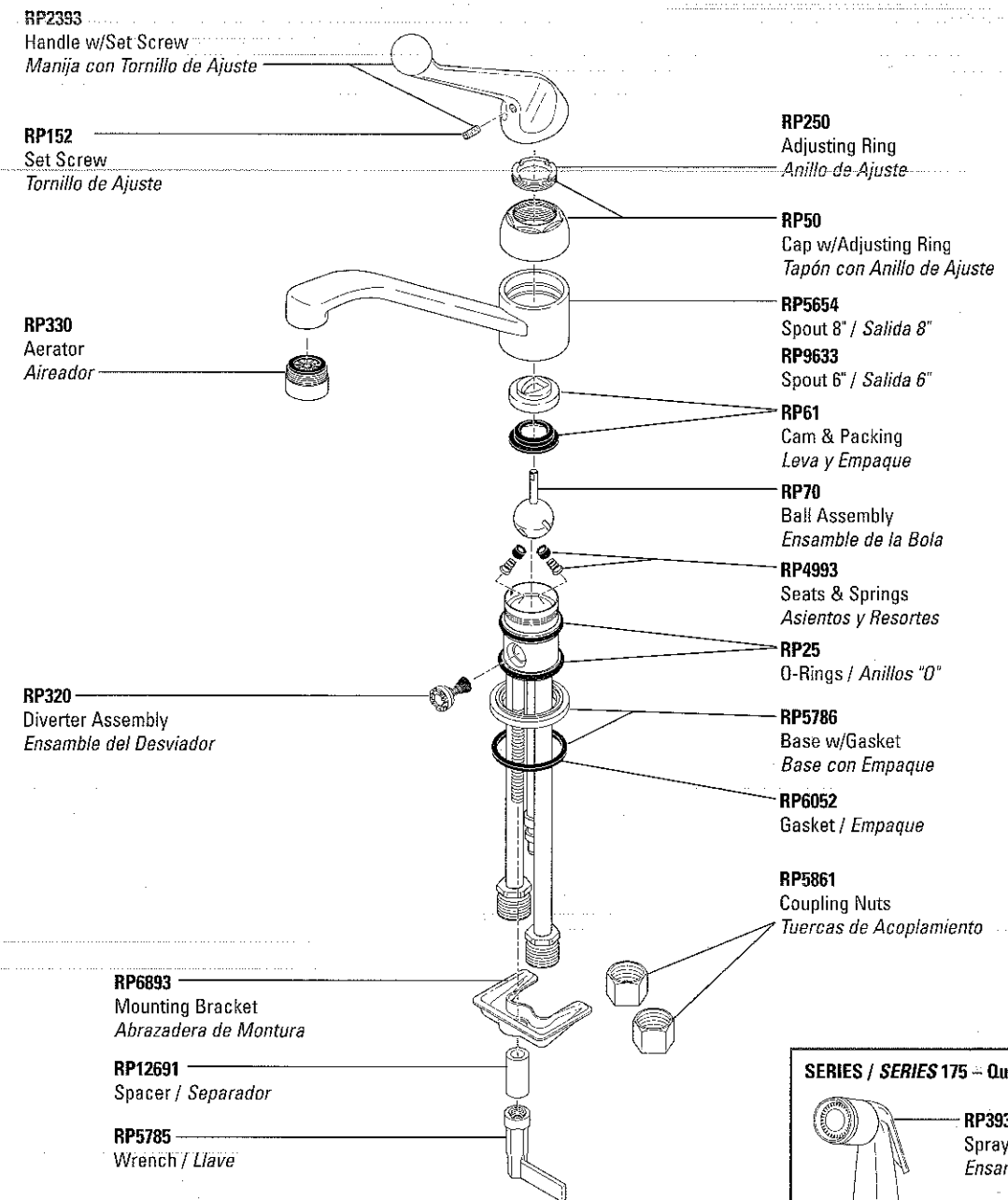

SERIES / SERIES 175 – Quick-Snap®

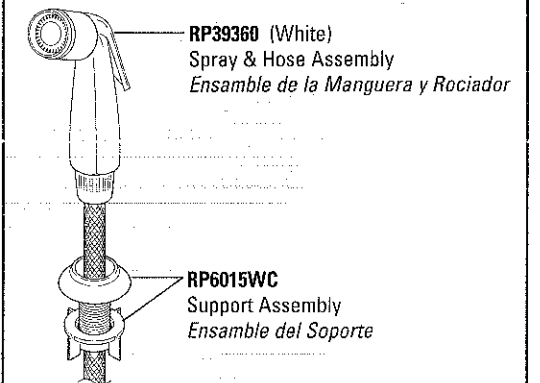

For non Quick-Snap® faucet models manufactured BEFORE September 2002, see page 34 for Vegetable Sprayers.

Para ver los modelos de llaves de agua sin Quick-Snap® fabricados ANTES de Septiembre 2002, vea la página 34 de Rociadores para Vegetales.

Thick tile mounting kit available as RP30394 allows installation up to 2 1/2" decks.
Las herramientas para la instalación en losas gruesas en el equipo RP30394 permiten la instalación en bordes hasta 2 1/2".

Specify finish / Especificque el Acabado.

Single Handle Kitchen Faucets

Manija de Palanca para Fregaderos

Classic Series Models/Modelos 120 & 420 Series

KITCHEN

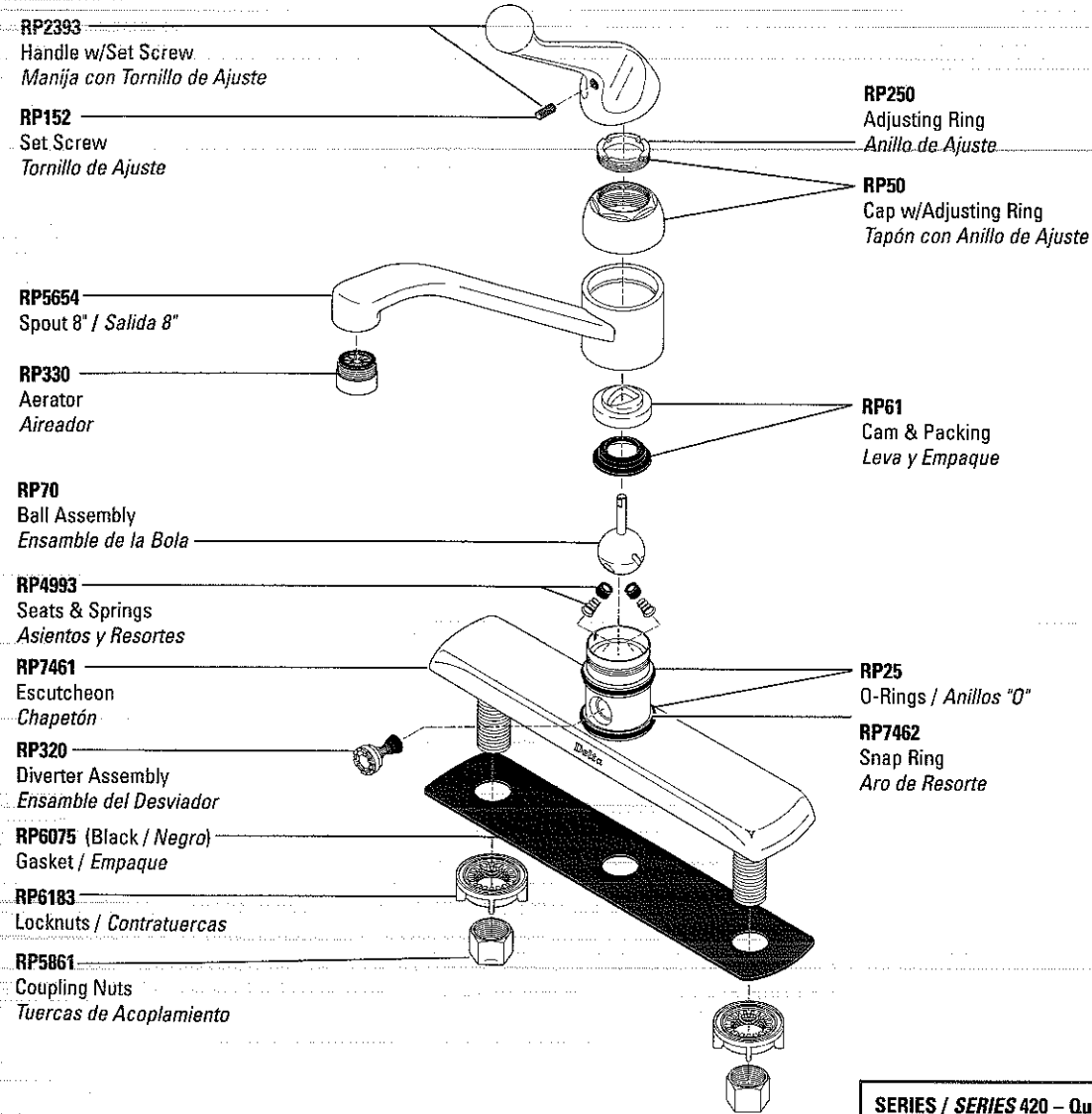

SERIES / SERIES 420 – Quick-Snap®

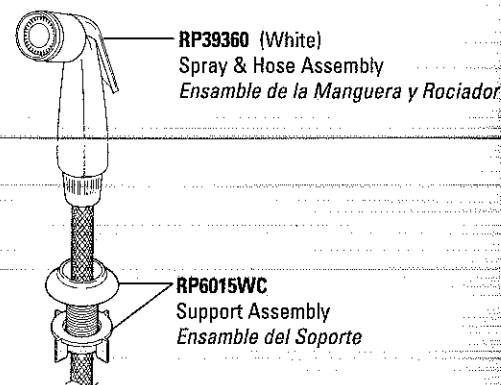

For non Quick-Snap® faucet models manufactured BEFORE September 2002, see page 34 for Vegetable Sprayers.

Para ver los modelos de llaves de agua sin Quick-Snap® fabricados ANTES de Septiembre 2002, vea la página 34 de Rociadores para Vegetales.

Thick tile mounting kit available as RP30393 allows installation up to 2 1/2" decks.
Las herramientas para la instalación en losas gruesas en el equipo RP30393 permiten la instalación en bordes hasta 2 1/2".

Single Handle Kitchen Faucets

Manija de Palanca para Fregaderos

Signature® Series Models/Modelos 140, 142*, 440 & 442* Series

KITCHEN

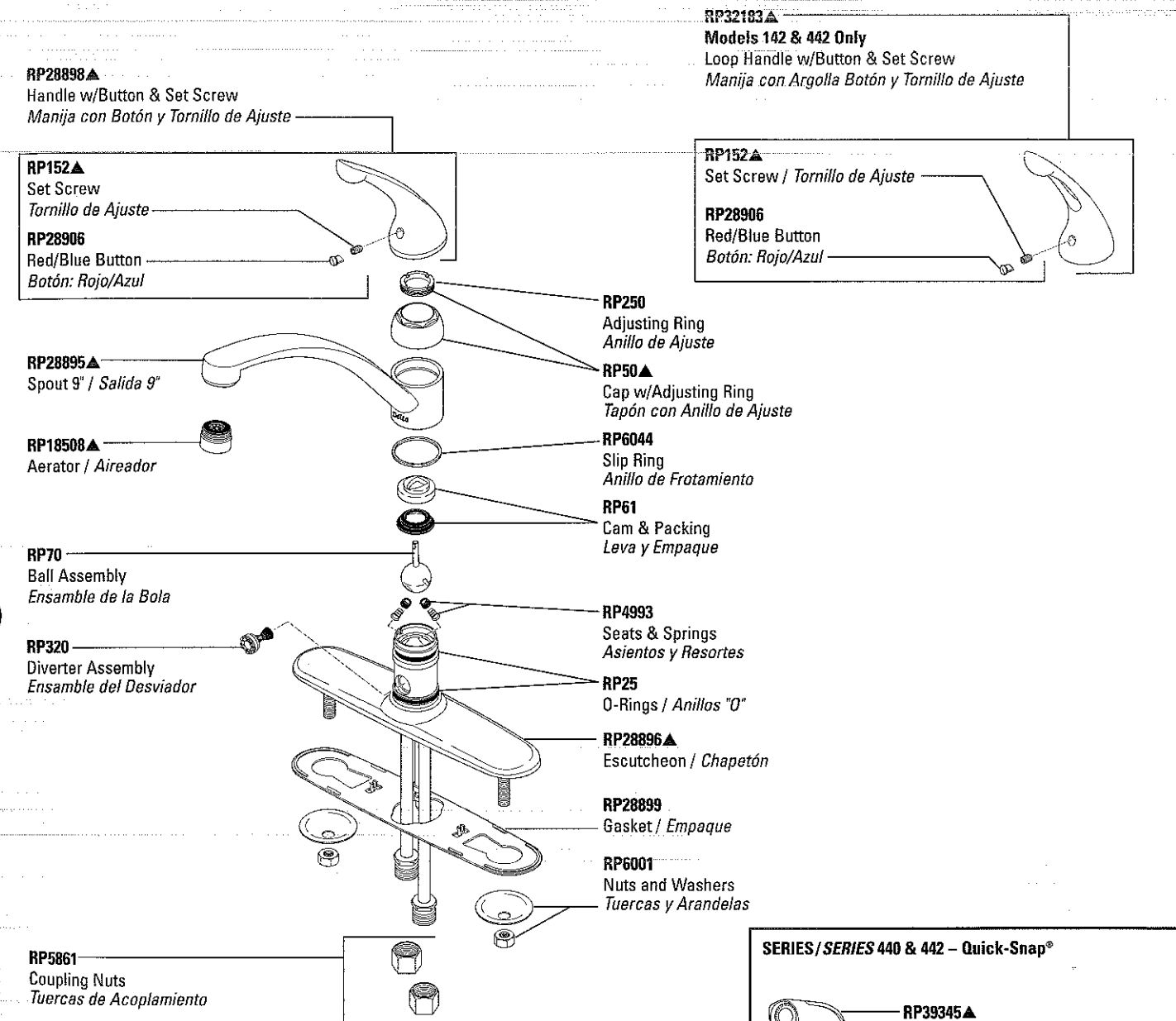

SERIES / SERIES 440 & 442 – Quick-Snap®

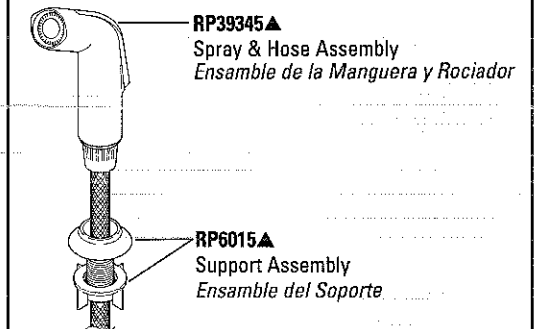

For non Quick-Snap® faucet models manufactured BEFORE September 2002, see page 34 for Vegetable Sprayers.

Para ver los modelos de llaves de agua sin Quick-Snap® fabricados ANTES de Septiembre 2002, vea la página 34 de Rociadores para Vegetales.

Thick tile mounting kit available as RP30393 allows installation up to 2 1/2" decks.
Las herramientas para la instalación en losas gruesas en el equipo RP30393 permiten la instalación en bordes hasta 2 1/2".

▲Specify finish / Especificar el Acabado

*Discontinued model—some components may not be available / Modelo discontinuado—algunos componentes pueden no estar disponibles.

Single Handle Kitchen Faucets

Manija de Palanca para Fregaderos

Signature® Series Models/Modelos 340, 342* & 380 Series

KITCHEN

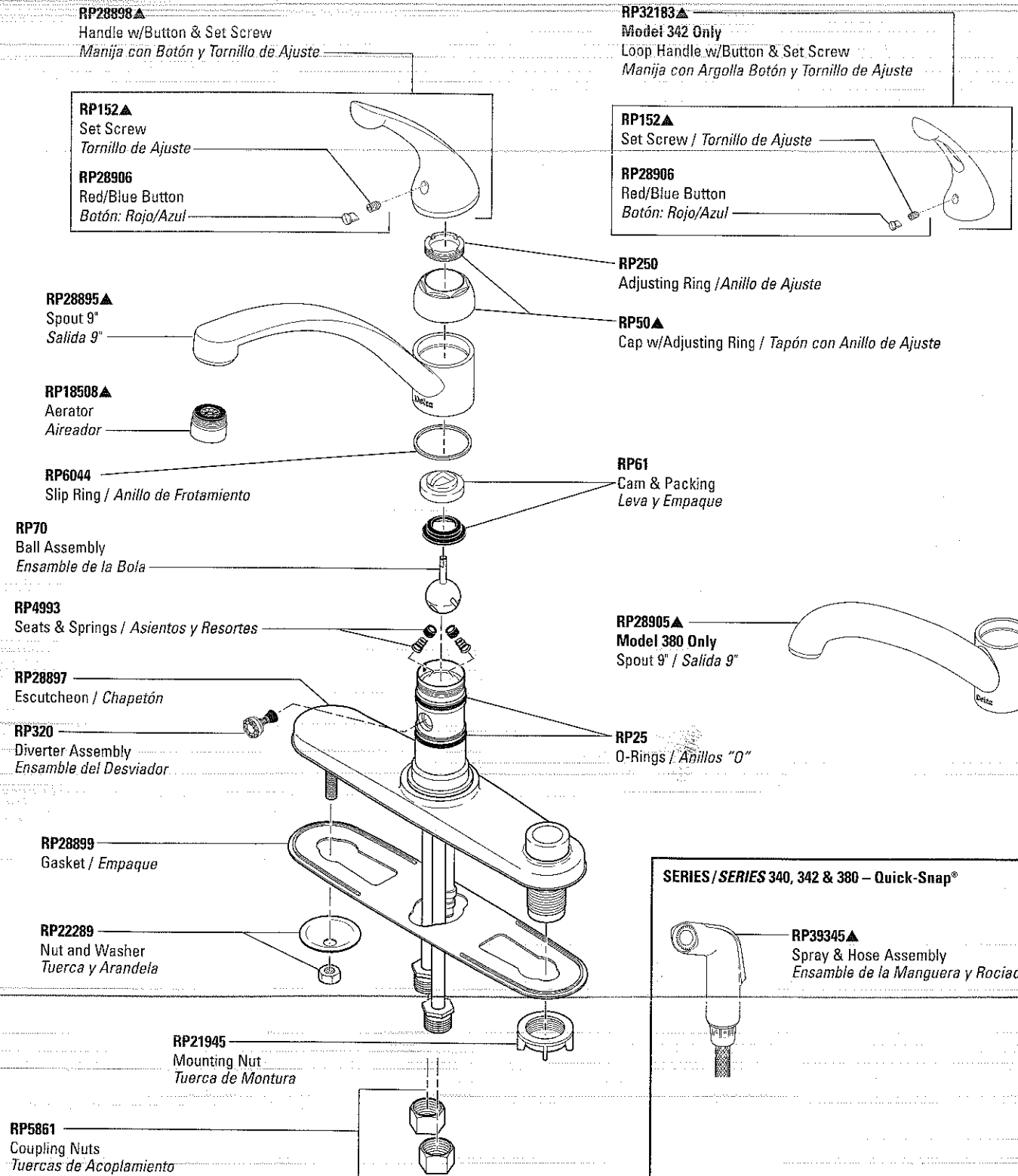

For non Quick-Snap® faucet models manufactured BEFORE September 2002, see page 34 for Vegetable Sprayers.
Para ver los modelos de llaves de agua sin Quick-Snap® fabricados ANTES de Septiembre 2002, vea la página 34 de Rociadores para Vegetales.

Thick tile mounting kit available as RP30393 & RP31845 allows installation up to 2 1/2" decks.
Las herramientas para la instalación en losas gruesas en el equipo RP30393 y RP31845 permiten la instalación en bordes hasta 2 1/2".

Single Handle Kitchen Faucets

Manija de Palanca para Fregaderos

Signature® Series Models/Modelos 141, 181*, 441, 443* & 481 Series

KITCHEN

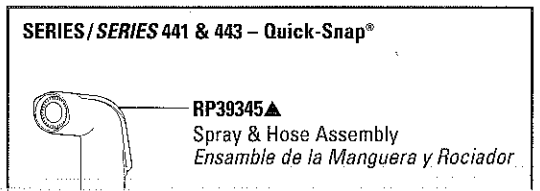
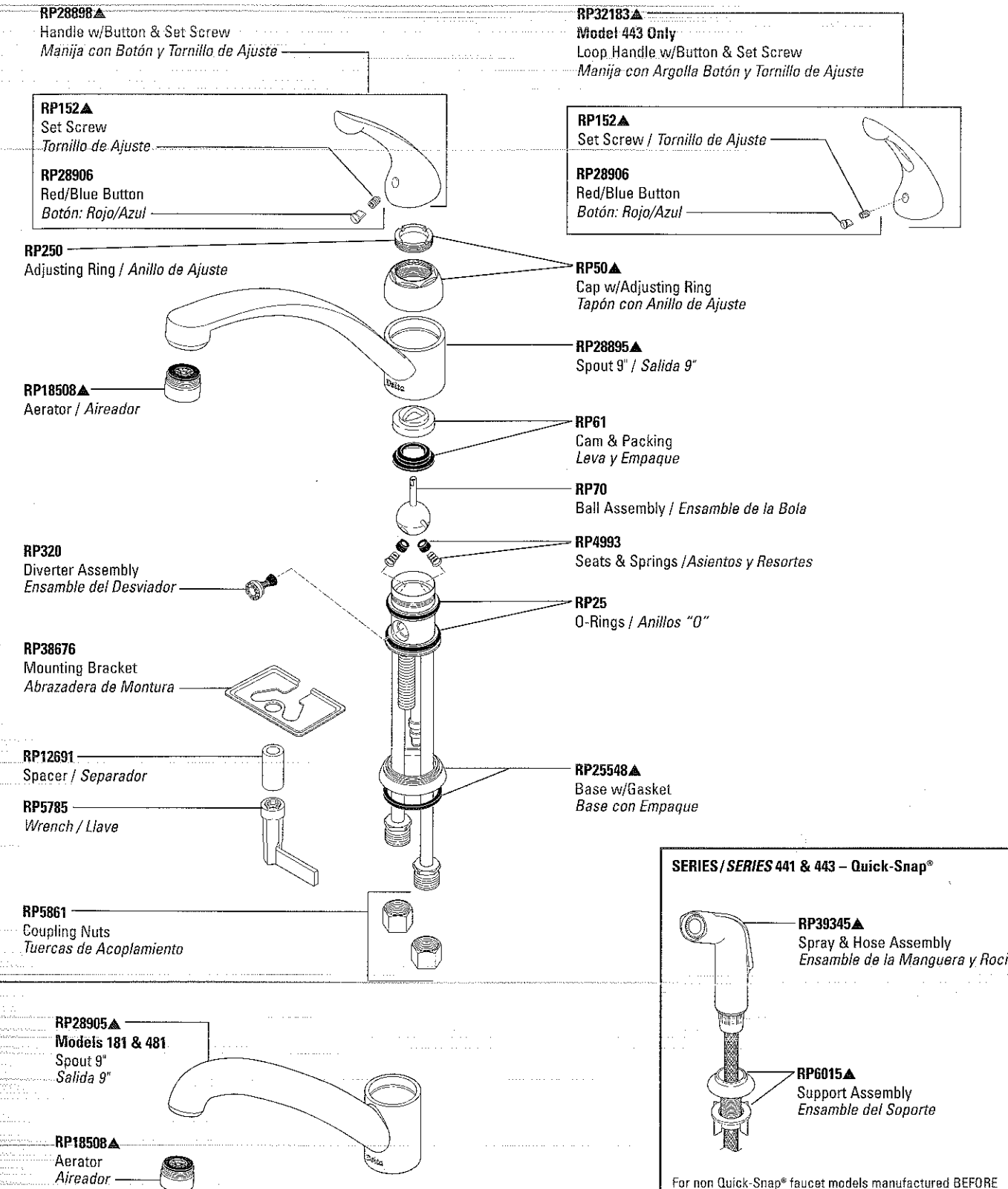

For non Quick-Snap® faucet models manufactured BEFORE September 2002, see page 34 for Vegetable Sprayers.
Para ver los modelos de llaves de agua sin Quick-Snap® fabricados ANTES de Septiembre 2002, vea la página 34 de Rociadores para Vegetales.

Thick tile mounting kit available as RP30394 allows installation up to 2 1/2" decks.
Las herramientas para la instalación en losas gruesas en el equipo RP30394 permiten la instalación en bordes hasta 2 1/2".

Single Handle Kitchen Faucets

Manija de Palanca para Fregaderos

Gourmet® Series Models/Modelos 150 & 450 Series

KITCHEN

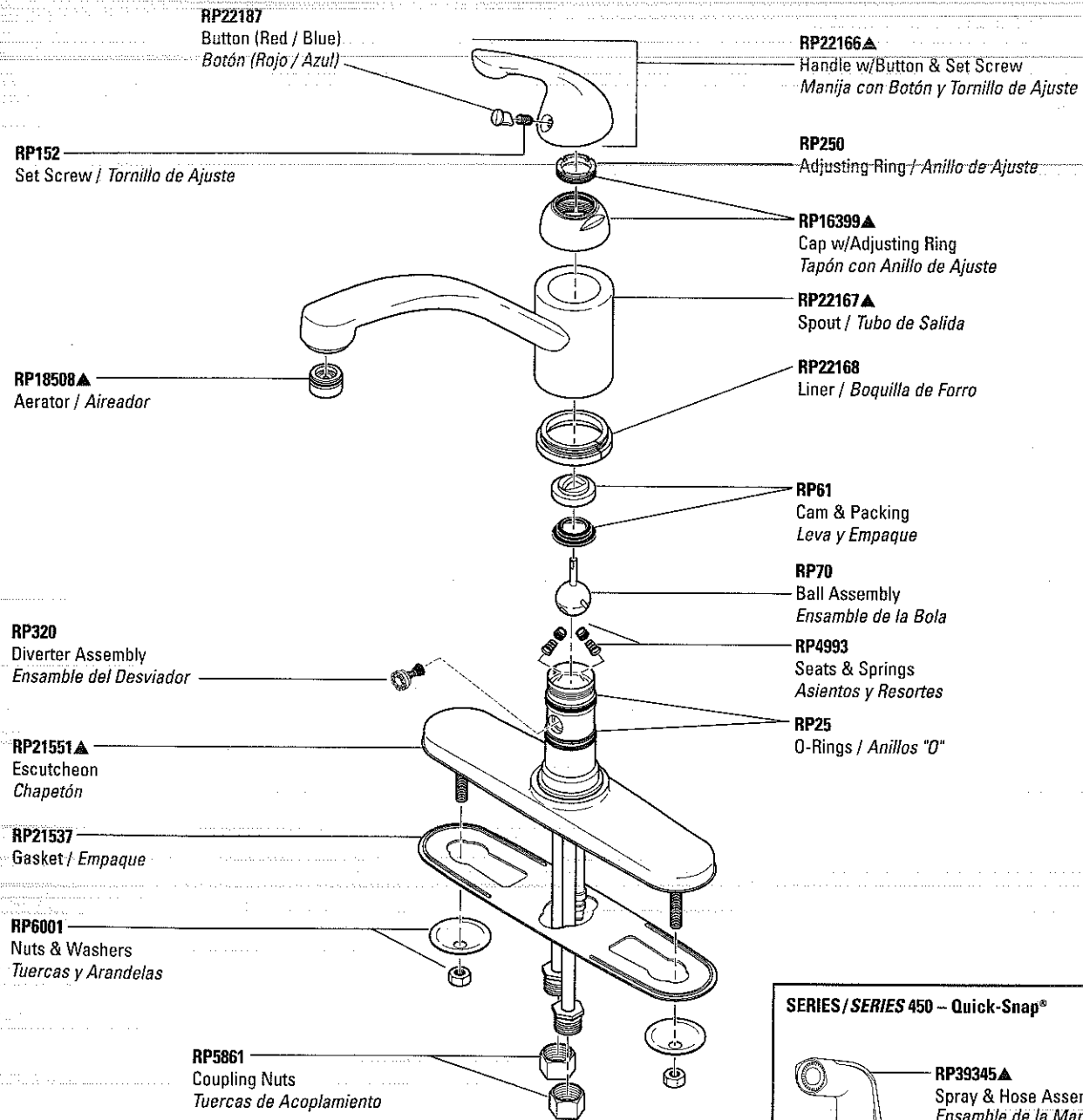

SERIES / SERIES 450 -- Quick-Snap®

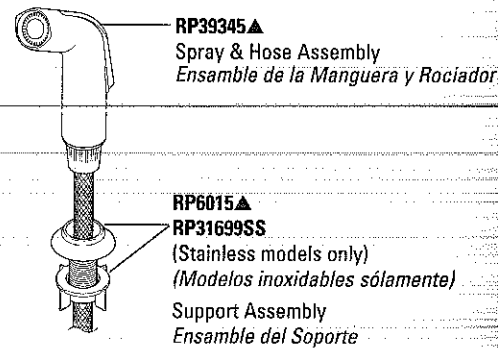

For non Quick-Snap® faucet models manufactured BEFORE September 2002, see page 34 for Vegetable Sprayers.

Para ver los modelos de llaves de agua sin Quick-Snap® fabricados ANTES de Septiembre 2002, vea la página 34 de Rociadores para Vegetales.

Thick tile mounting kit available as RP30393 allows installation up to 2 1/2" decks.
Las herramientas para la instalación en losas gruesas en el equipo RP30393 permiten la instalación en bordes hasta 2 1/2".

Single Handle Kitchen Faucets

Manija de Palanca para Fregaderos

Gourmet® Series Models/Modelos 151* & 451 Series

KITCHEN

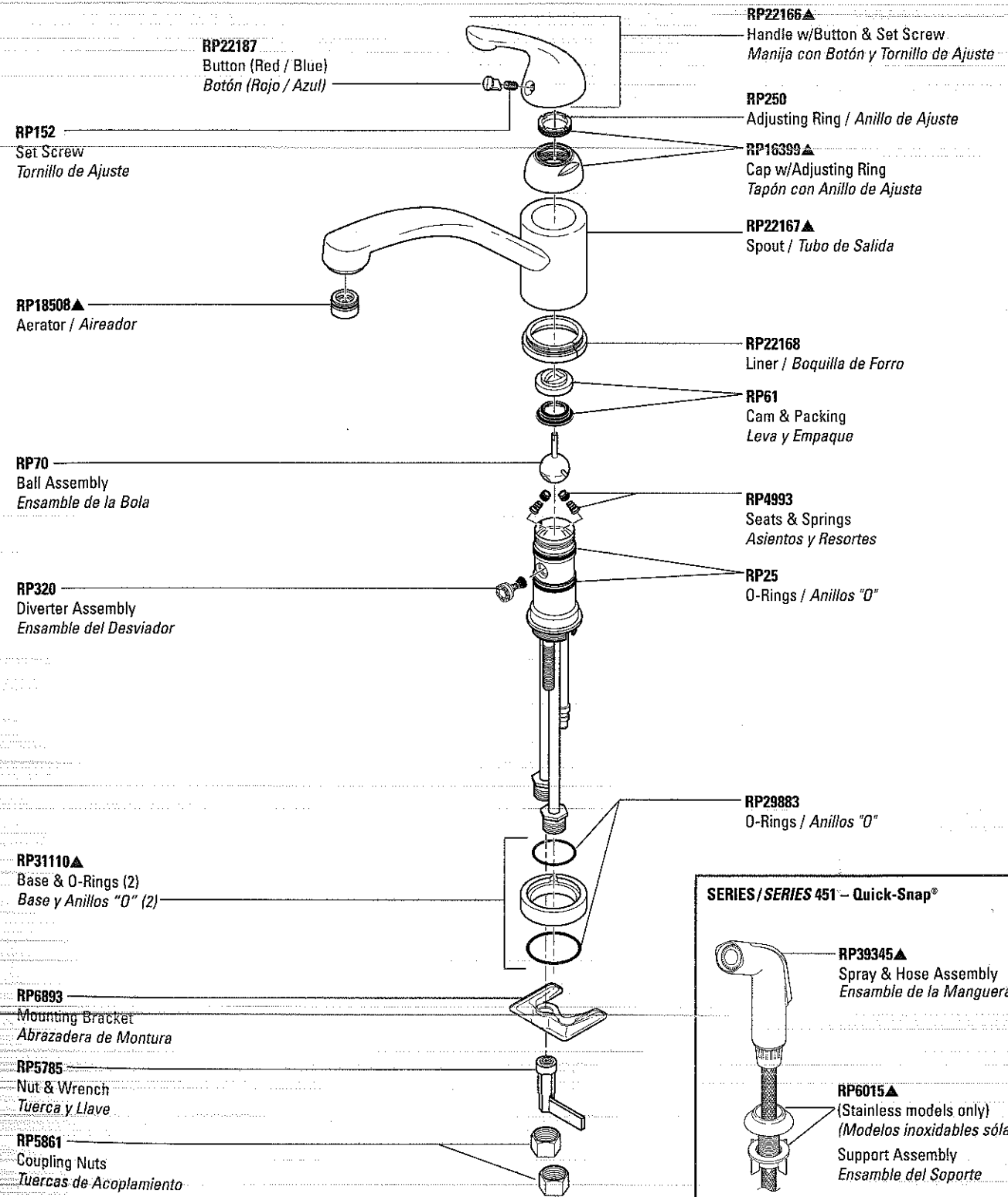

SERIES / SERIES 451 -- Quick-Snap®

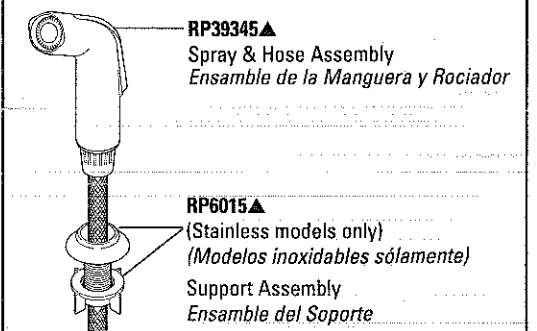

For non Quick-Snap® faucet models manufactured BEFORE September 2002, see page 34 for Vegetable Sprayers.

Para ver los modelos de llaves de agua sin Quick-Snap® fabricados ANTES de Septiembre 2002, vea la página 34 de Rociadores para Vegetales.

Thick tile mounting kit available as RP30393 allows installation up to 2 1/2" decks.
Las herramientas para la instalación en losas gruesas en el equipo RP30393 permiten la instalación en bordes hasta 2 1/2".

▲Specify finish / Especificque el Acabado

*Discontinued model—some components may not be available / Modelo discontinuado—algunos componentes pueden no estar disponibles.

Single Handle Kitchen Faucets Manija de Palanca para Fregaderos

Gourmet® Series Model/Modelo 350 Series

KITCHEN

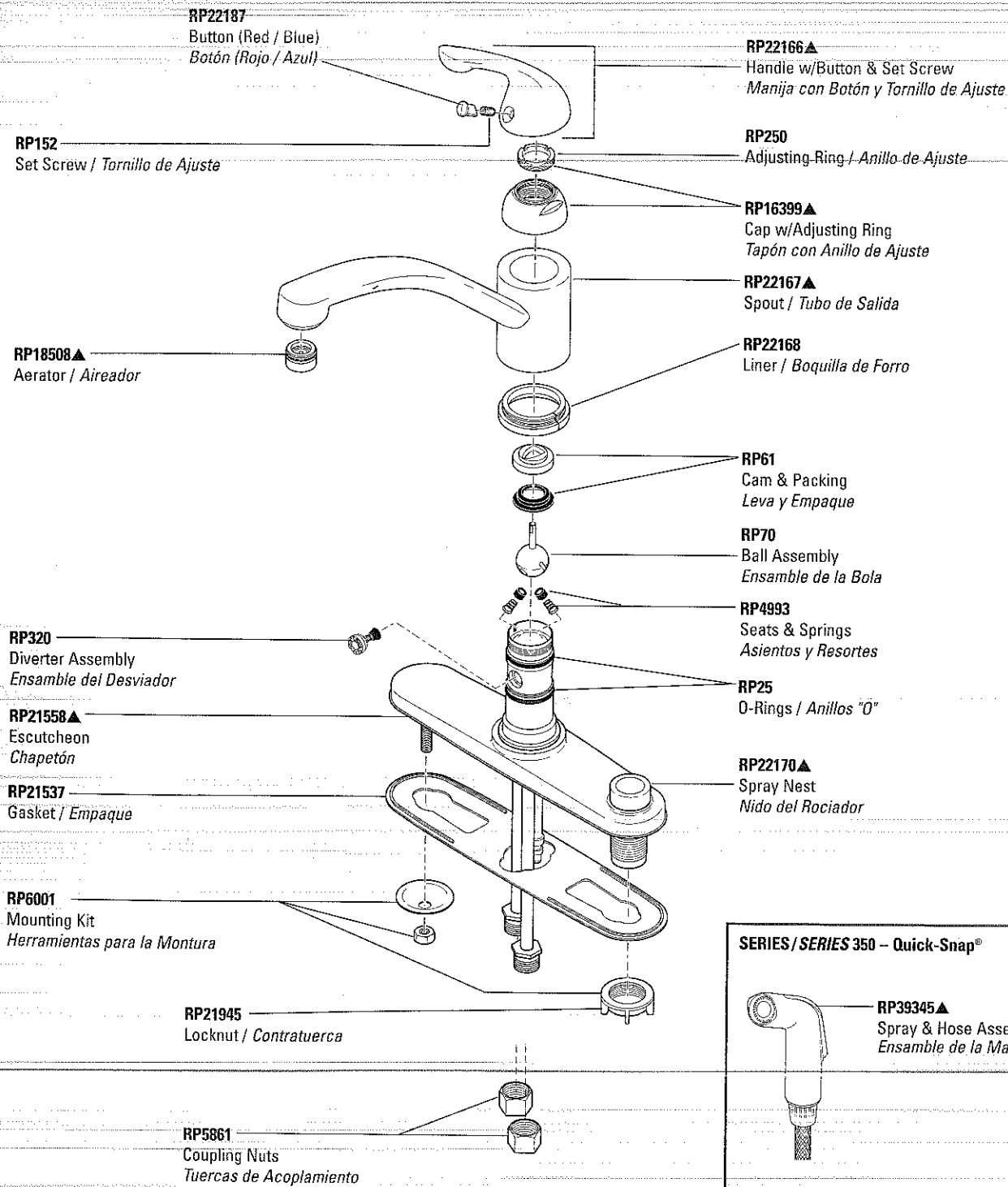

SERIES / SERIES 350 - Quick-Snap®

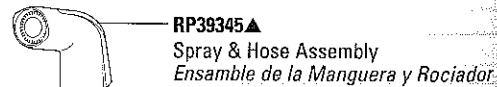

For non Quick-Snap® faucet models manufactured BEFORE September 2002, see page 34 for Vegetable Sprayers.

Para ver los modelos de llaves de agua sin Quick-Snap® fabricados ANTES de Septiembre 2002, vea la página 34 de Rociadores para Vegetales.

Thick tile mounting kit available as RP30393 & RP30394 allows installation up to 2 1/2" decks.
Las herramientas para la instalación en losas gruesas en el equipo RP30393 y RP30394 permiten la instalación en bordes hasta 2 1/2".

Single Handle Kitchen Faucets Manija de Palanca para Fregaderos

Victorian® Collection Models/Modelos 155, 156, 157 & 158 Series

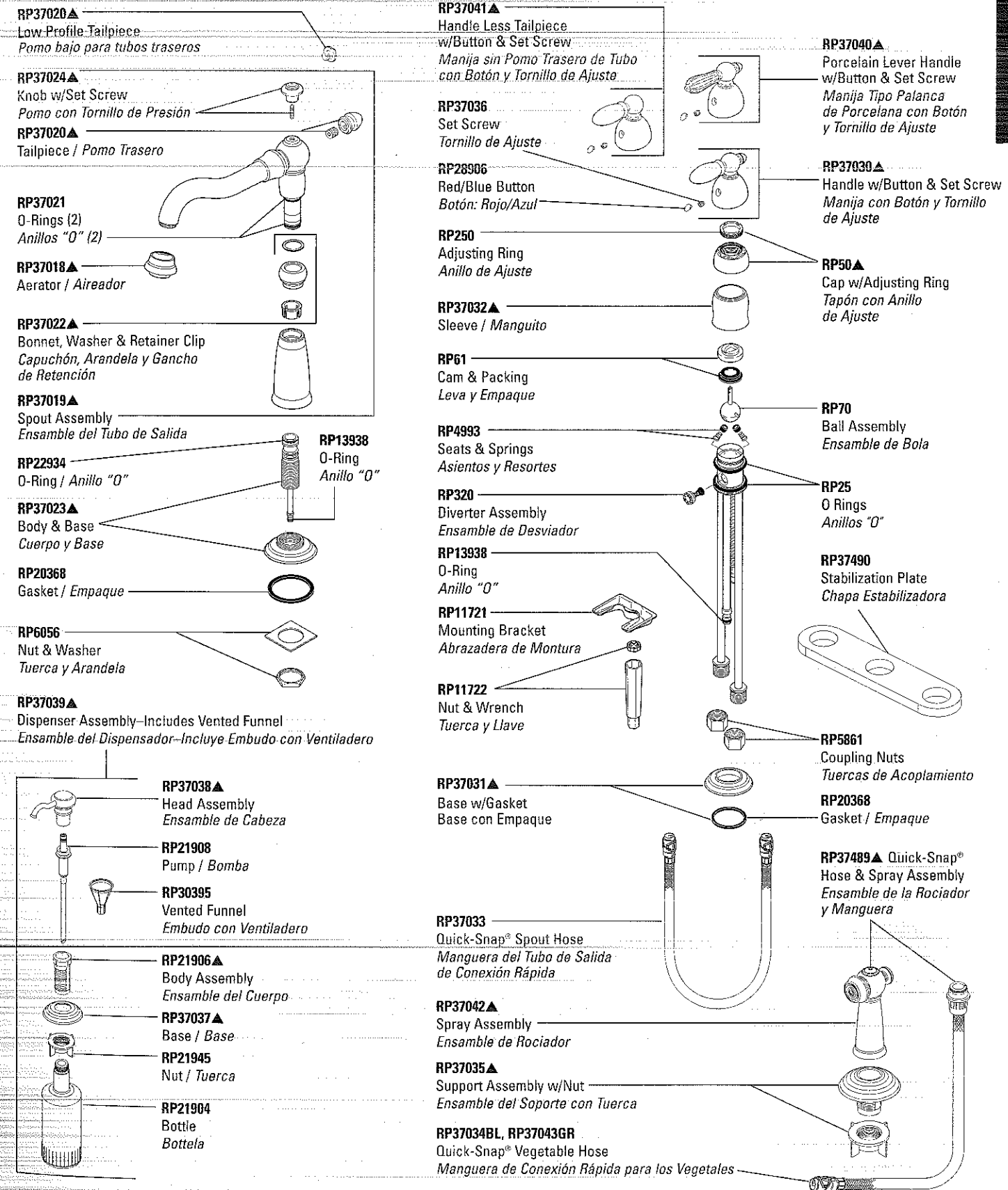

Thick tile mounting kit available as RP37776 allows installation up to 2 1/4" decks.
Las herramientas para la instalación en losas gruesas en el equipo RP37776 permiten la instalación en bordes hasta 2 1/4".

Specify finish / Especificue el Acabado

KITCHEN

Single Handle Kitchen Faucets

Manija de Palanca para Fregaderos

Waterfall® Series Models/Modelos 172, 173*, 174, 176* & 178* Series

For Models manufactured BEFORE September 2002 / Para los modelos fabricados ANTES de Septiembre 2002

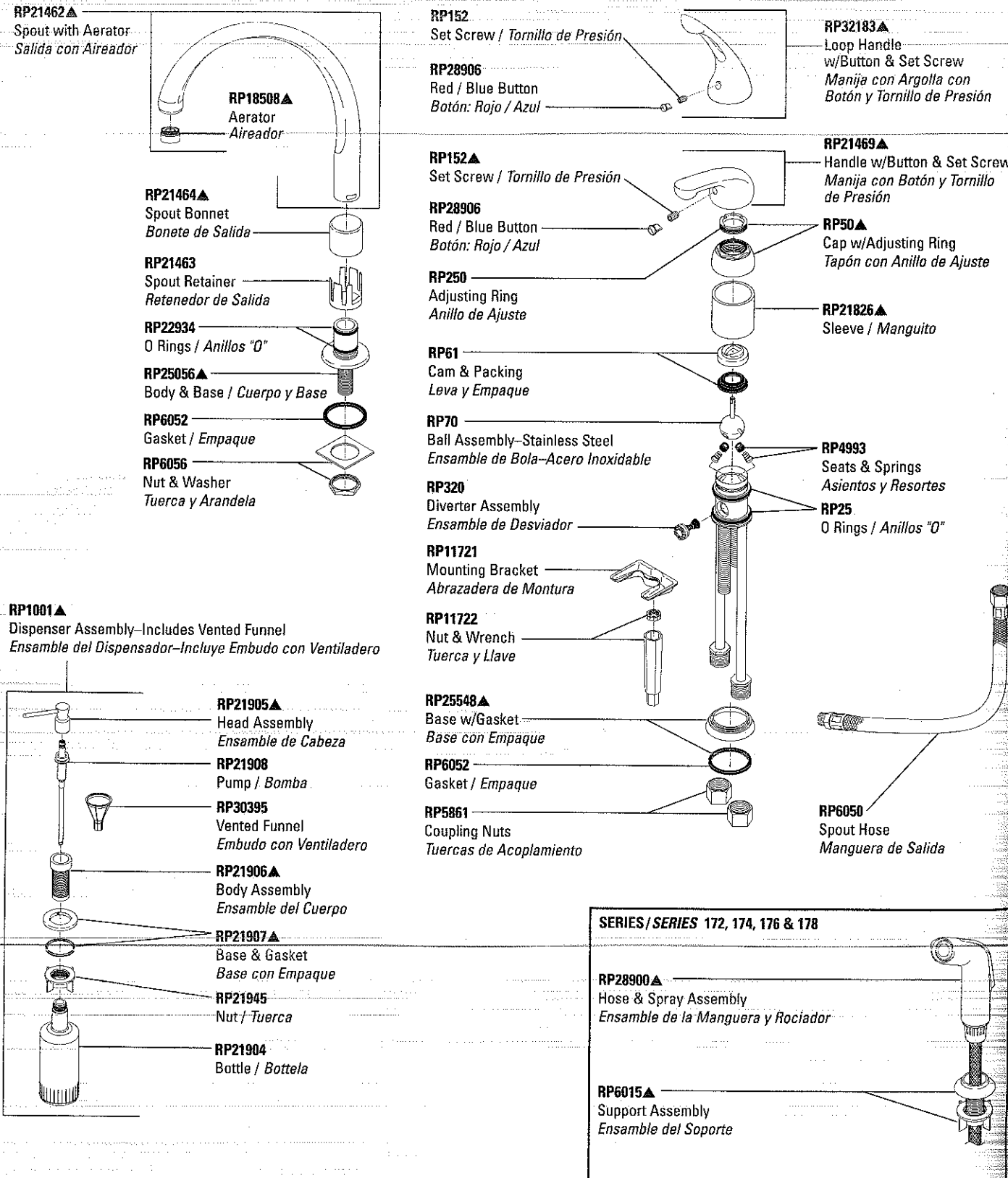

Thick tile mounting kit available as RP30392 allows installation up to 2 1/2" decks.
Las herramientas para la instalación en losas gruesas en el equipo RP30392 permiten la instalación en bordes hasta 2 1/2".

▲Specify finish / Especifique el Acabado
*Discontinued model—some components may not be available / Modelo discontinuado—algunos componentes pueden no estar disponibles.

Single Handle Kitchen Faucets

Manija de Palanca para Fregaderos

Waterfall® Series Models/Modelos 172, 173*, 174, 176* & 178* Series

For Models manufactured AFTER September 2002 / Para los modelos fabricados DESPUÉS de Septiembre 2002

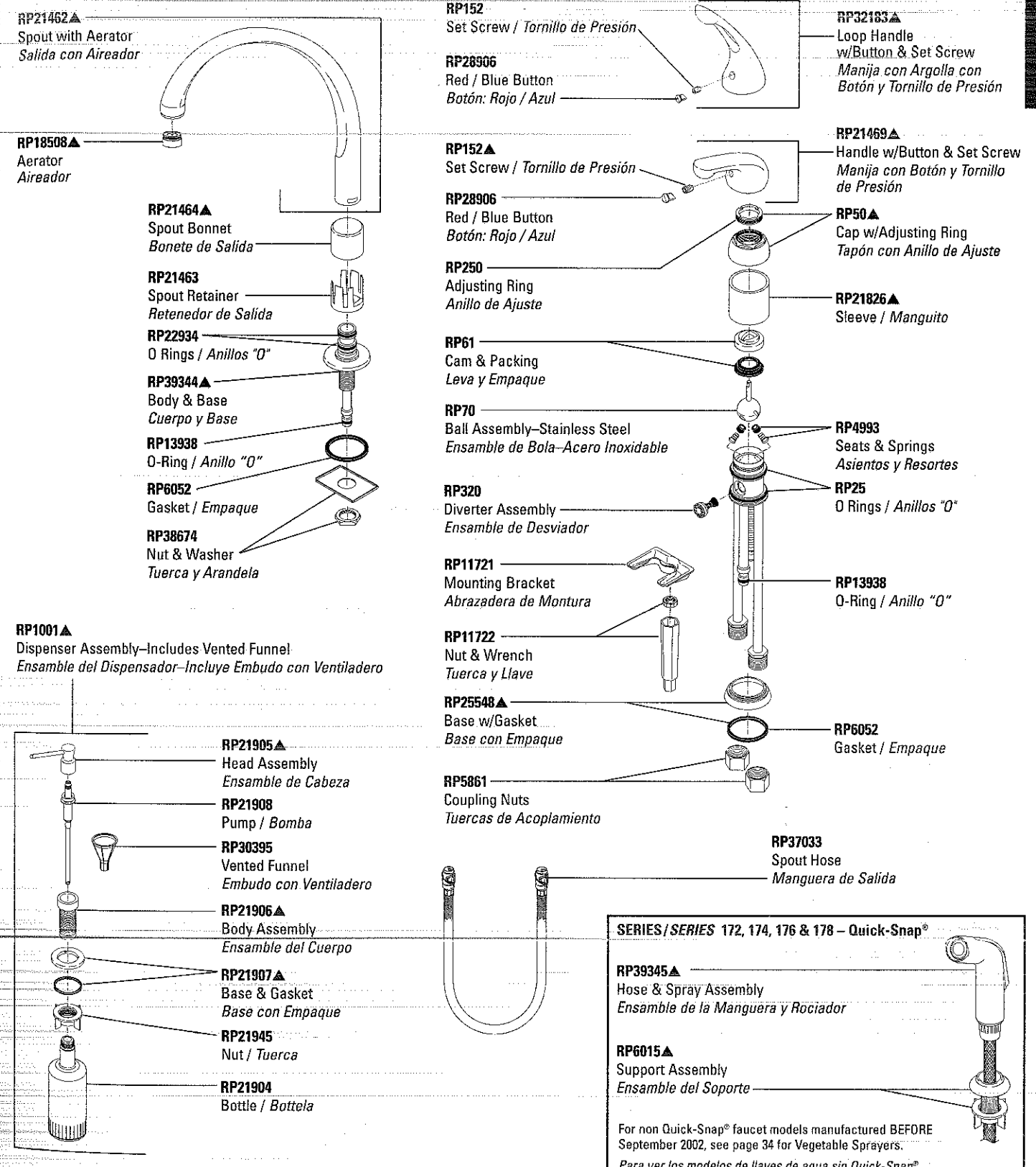

Thick tile mounting kit available as RP30392 allows installation up to 2 1/2" decks.
Las herramientas para la instalación en losas gruesas en el equipo RP30392 permiten la instalación en bordes hasta 2 1/2".

▲Specify finish / Especifique el Acabado
*Discontinued model—some components may not be available / Modelo discontinuado—algunos componentes pueden no estar disponibles.

Single Handle Kitchen Faucets Manija de Palanca para Fregaderos

Classic Series Models/Modelos 200 & 275* Series

KITCHEN

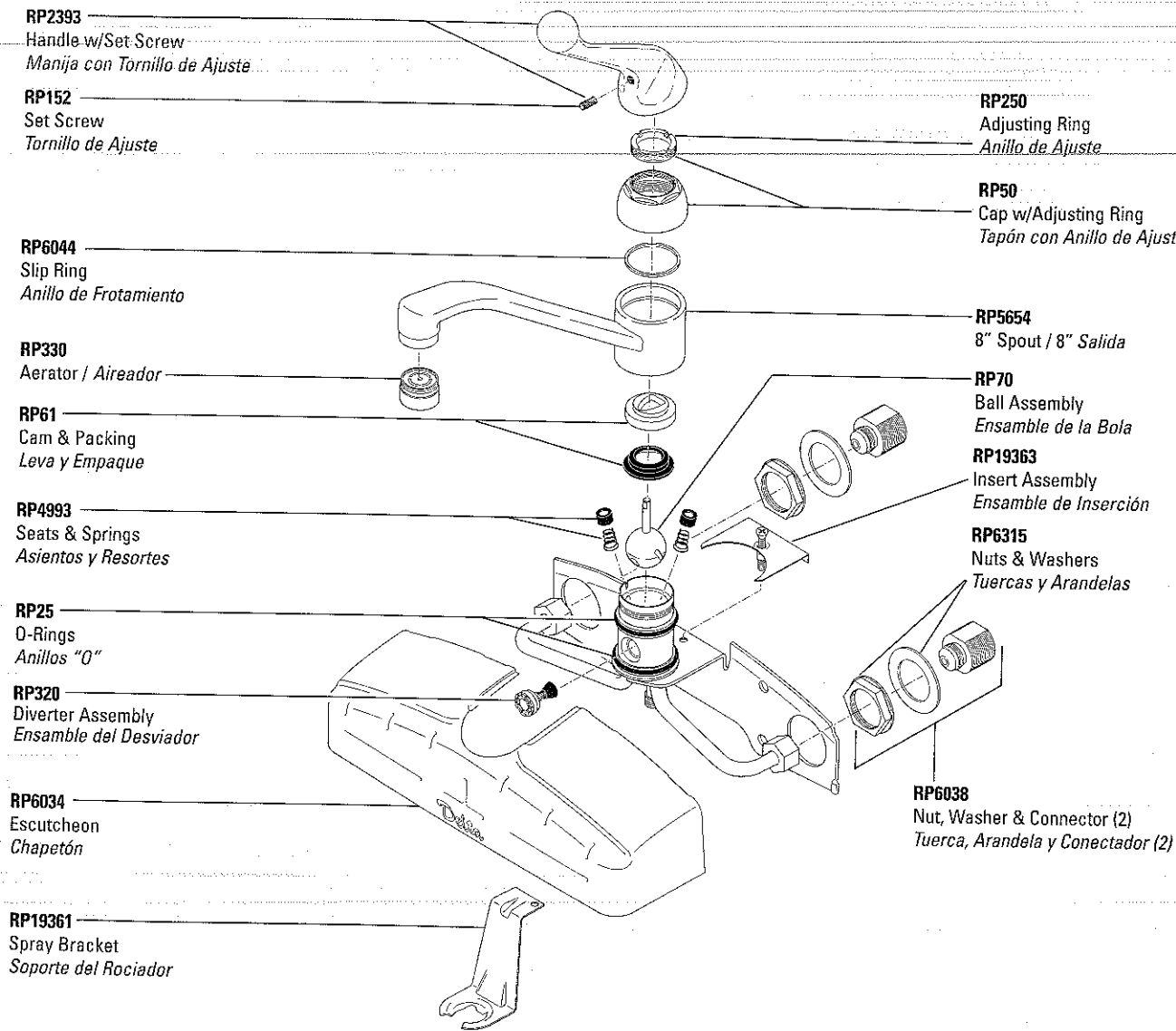

RP19362
Spray & Hose Assembly
Ensamble de Rociador y Manguera

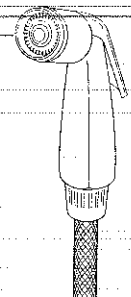

Single Handle Kitchen Faucets Manija de Palanca para Fregaderos

Innovations® Series Models/Modelos 180 & 480 Series

KITCHEN

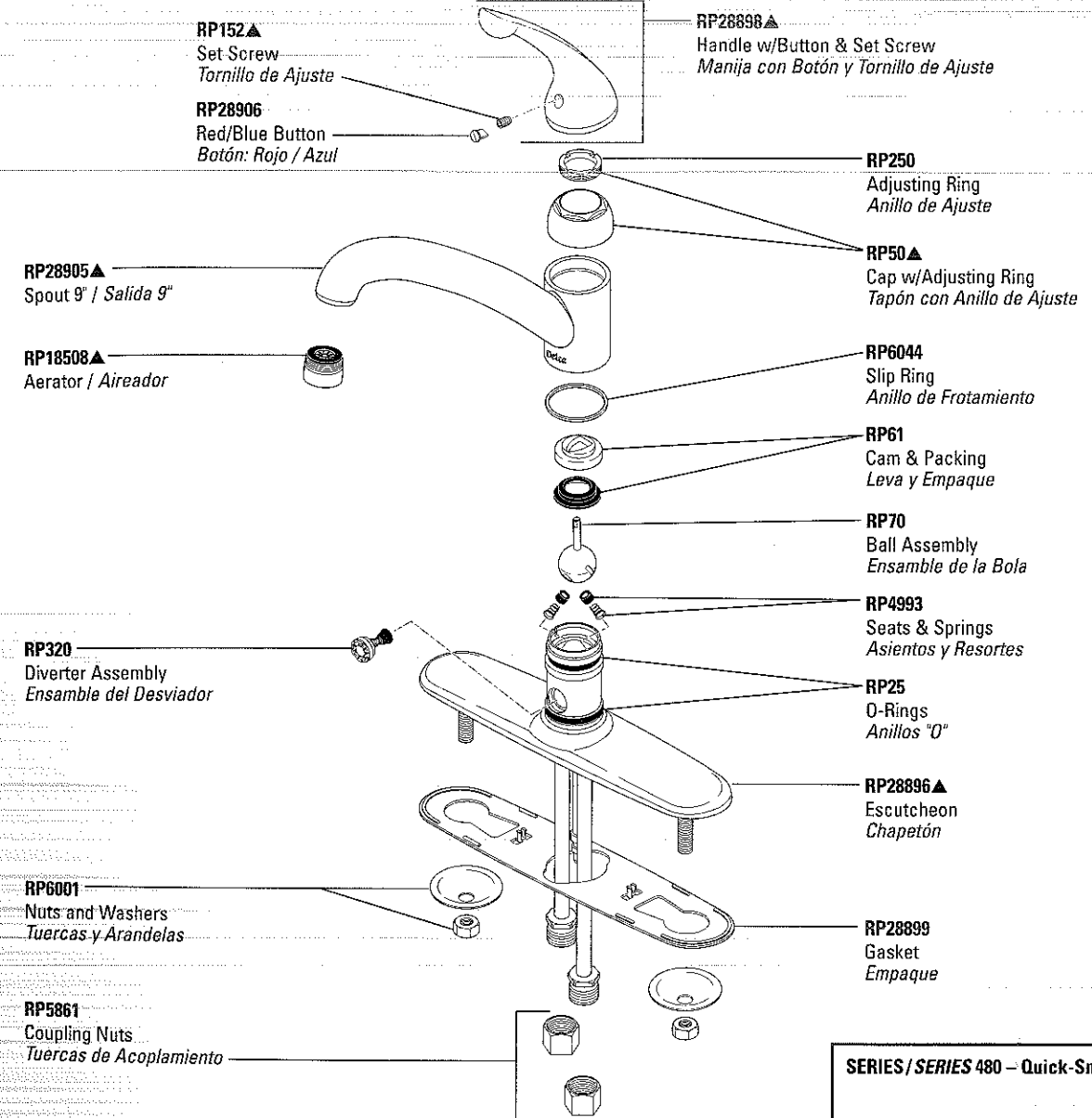

SERIES / SERIES 480 – Quick-Snap®

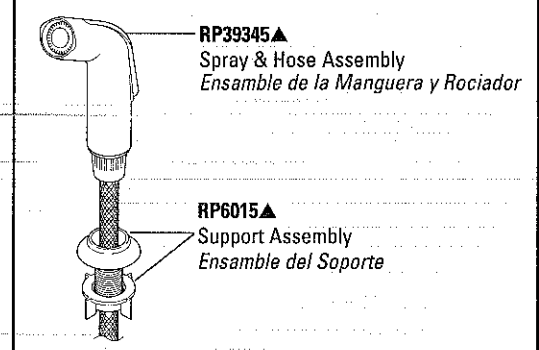

For non Quick-Snap® faucet models manufactured BEFORE September 2002, see page 34 for Vegetable Sprayers.
Para ver los modelos de llaves de agua sin Quick-Snap® fabricados ANTES de Septiembre 2002, vea la página 34 de Rociadores para Vegetales.

Thick tile mounting kit available as RP30393 allows installation up to 2 1/2" decks.
Las herramientas para la instalación en losas gruesas en el equipo RP30393 permiten la instalación en bordes hasta 2 1/2".

▲Specify finish / Especifique el Acabado.

Single Handle Kitchen Faucets

Manija de Palanca para Fregaderos

MICHAEL GRAVES
COLLECTION

Models/Modelos 186 & 187 Series

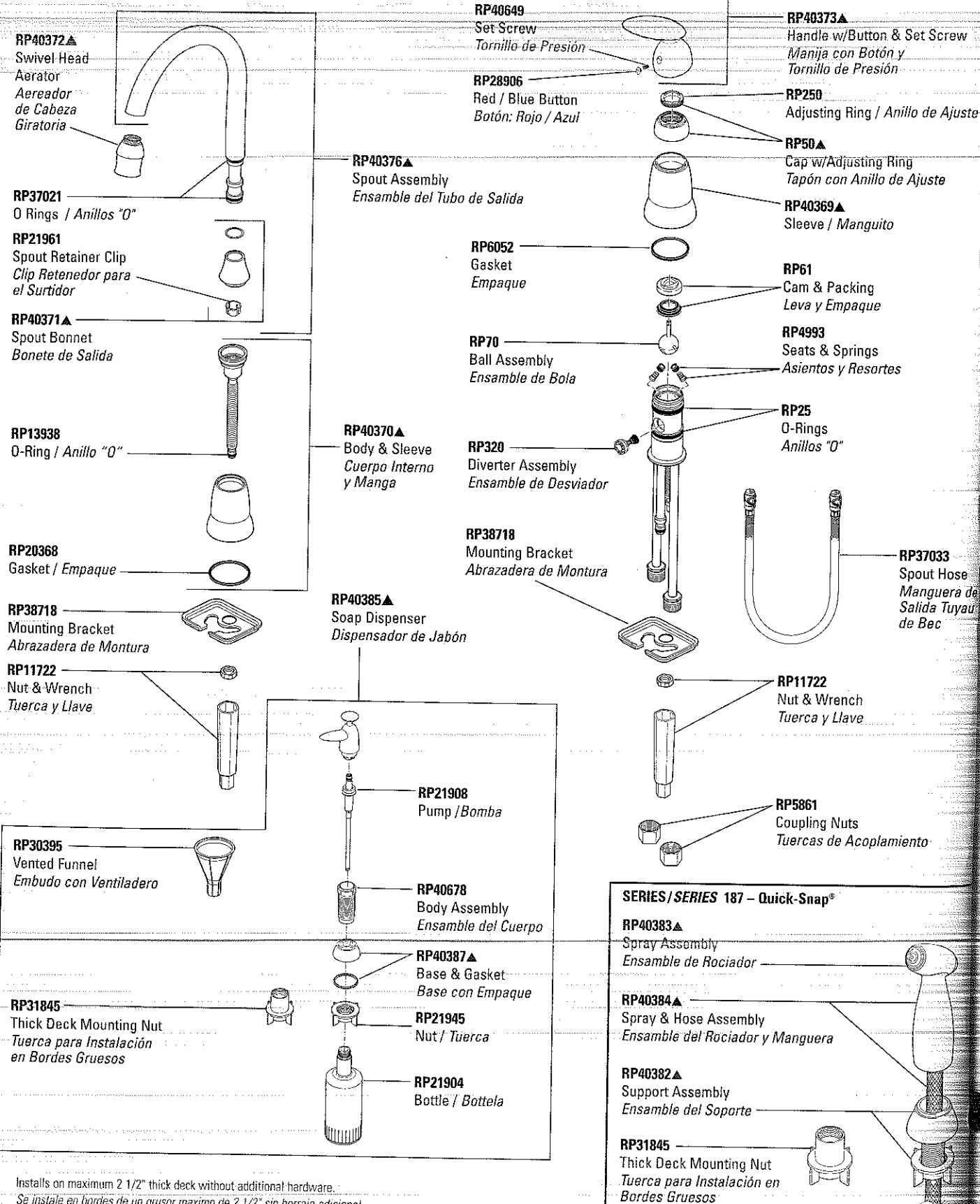

Installs on maximum 2 1/2" thick deck without additional hardware.
Se instala en bordes de un grosor máximo de 2 1/2" sin herraje adicional.

▲Specify finish / Especificque el Acabado

Single Handle Kitchen Faucets

Manija de Palanca para Fregaderos

MICHAEL GRAVES
COLLECTION

Models/Modelos 188 & 488 Series

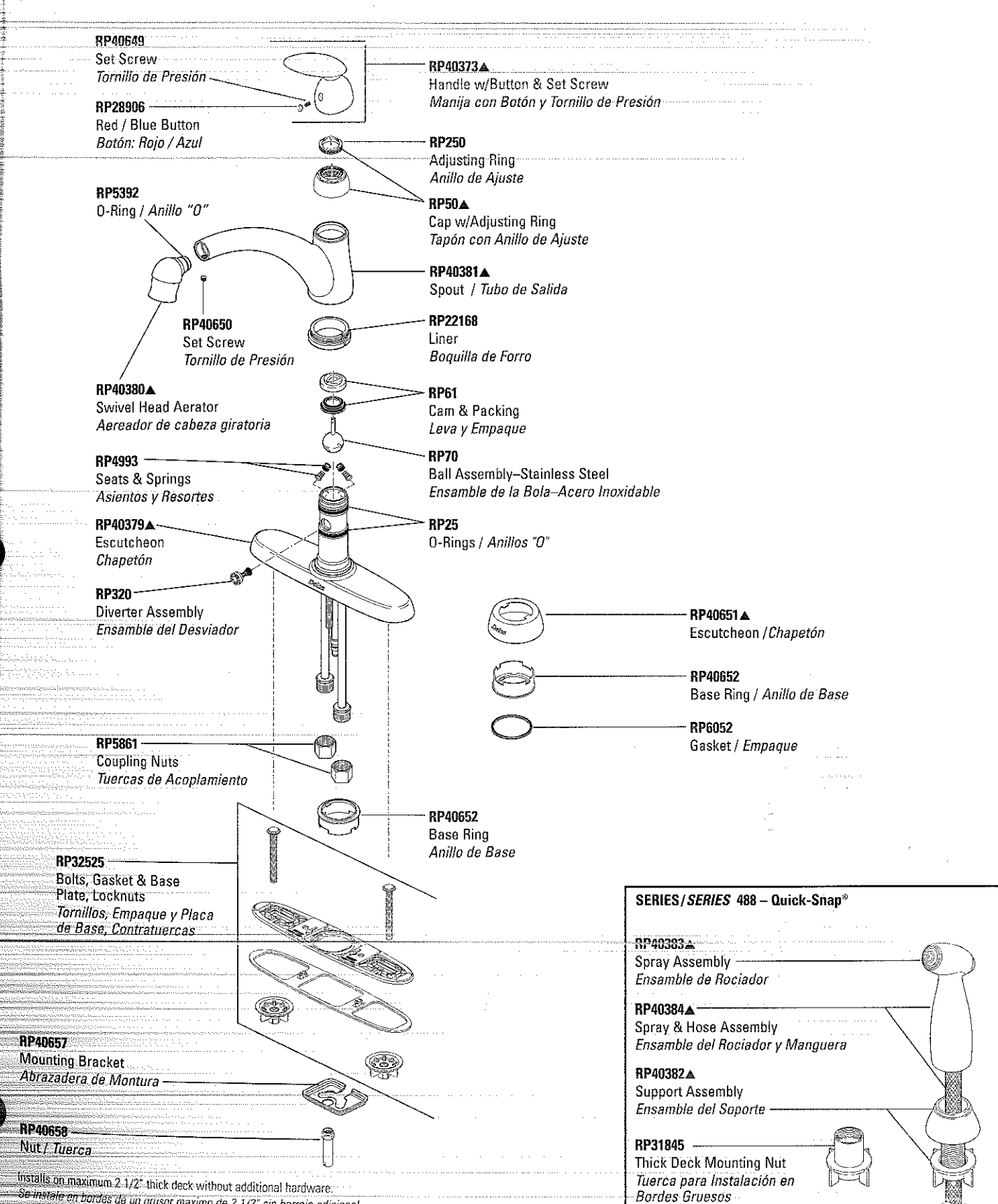

Installs on maximum 2 1/2" thick deck without additional hardware.
Se instala en bordes de un grosor máximo de 2 1/2" sin herraje adicional.

▲Specify finish / Especificque el Acabado

Single Handle Kitchen Faucets Manija de Palanca para Fregaderos

The Gourmet Spray® Series Models/Modelos 462*, 466* Series

KITCHEN

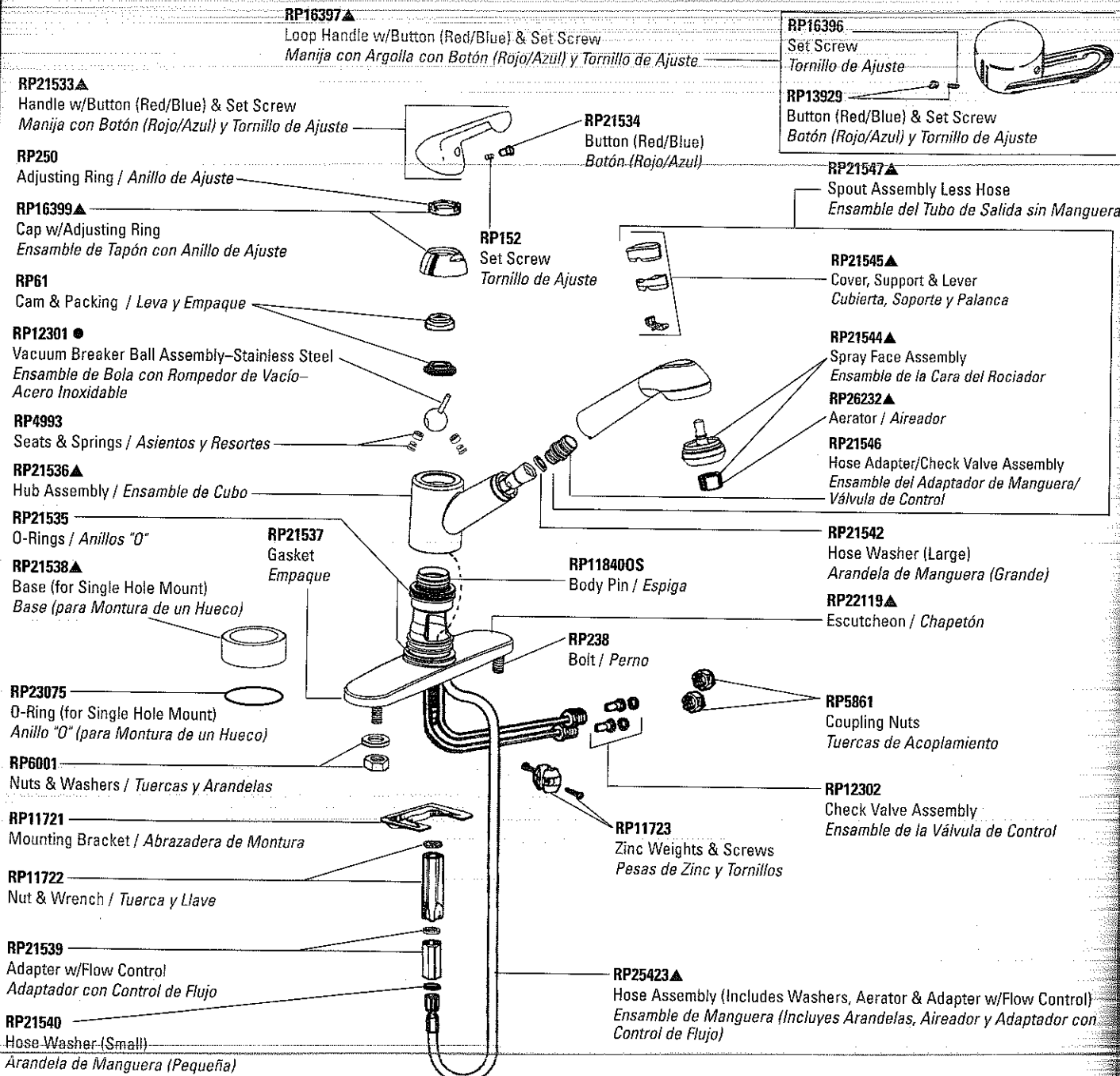

● The vacuum breaker ball assembly is an important part of protecting your drinking water from contamination by back siphonage. Use only the Delta RP12301 ball assembly.
El conjunto de bola con rompevacío es una parte importante en proteger su agua potable de contaminación por causa del retrocedimiento de agua. Use sólo el conjunto de bola Delta RP12301

▲Specify finish / Especifique el Acabado

*Discontinued model—some components may not be available / Modelo descontinuado—algunos componentes pueden no estar disponibles.

Single Handle Kitchen Faucets Manija de Palanca para Fregaderos

Signature® Pull-Out Series Models/Modelos 470, 472 Series

KITCHEN

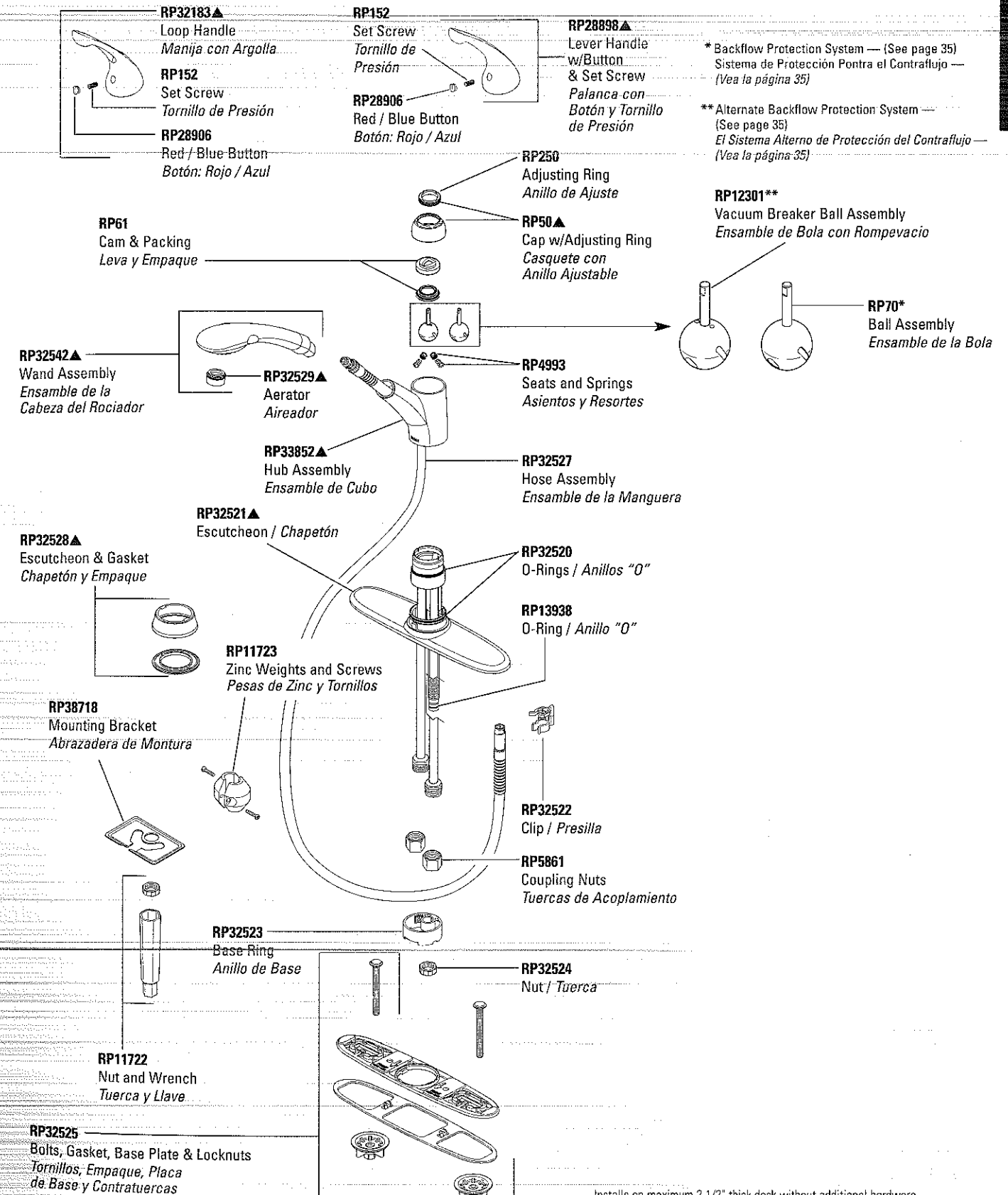

* Backflow Protection System — (See page 35)
Sistema de Protección Pontra el Contraflujo — (Vea la página 35)

** Alternate Backflow Protection System — (See page 35)
El Sistema Alterno de Protección del Contraflujo — (Vea la página 35)

Installs on maximum 2 1/2" thick deck without additional hardware.
Se instala en bordes de un grosor máximo de 2 1/2" sin herraje adicional.

▲Specify finish / Especifique el Acabado

Single Handle Kitchen Faucets Manija de Palanca para Fregaderos

Saxony™ Pull-Out Series Models/Modelos 473 & 473-SD Series

KITCHEN

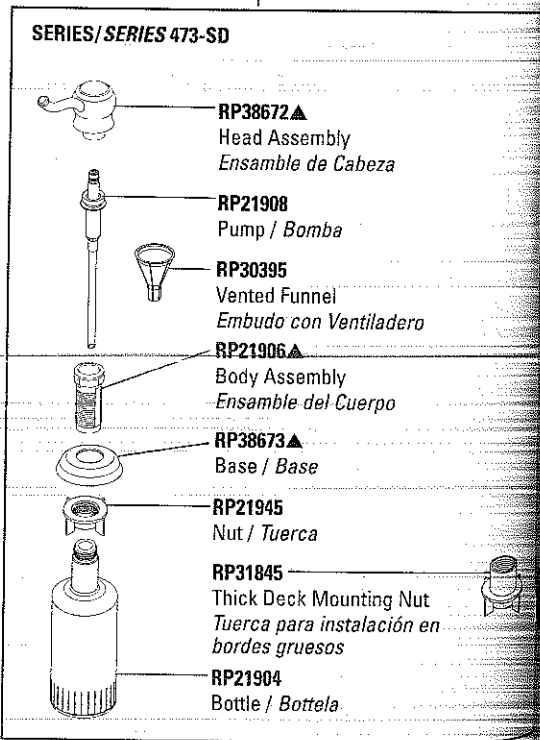
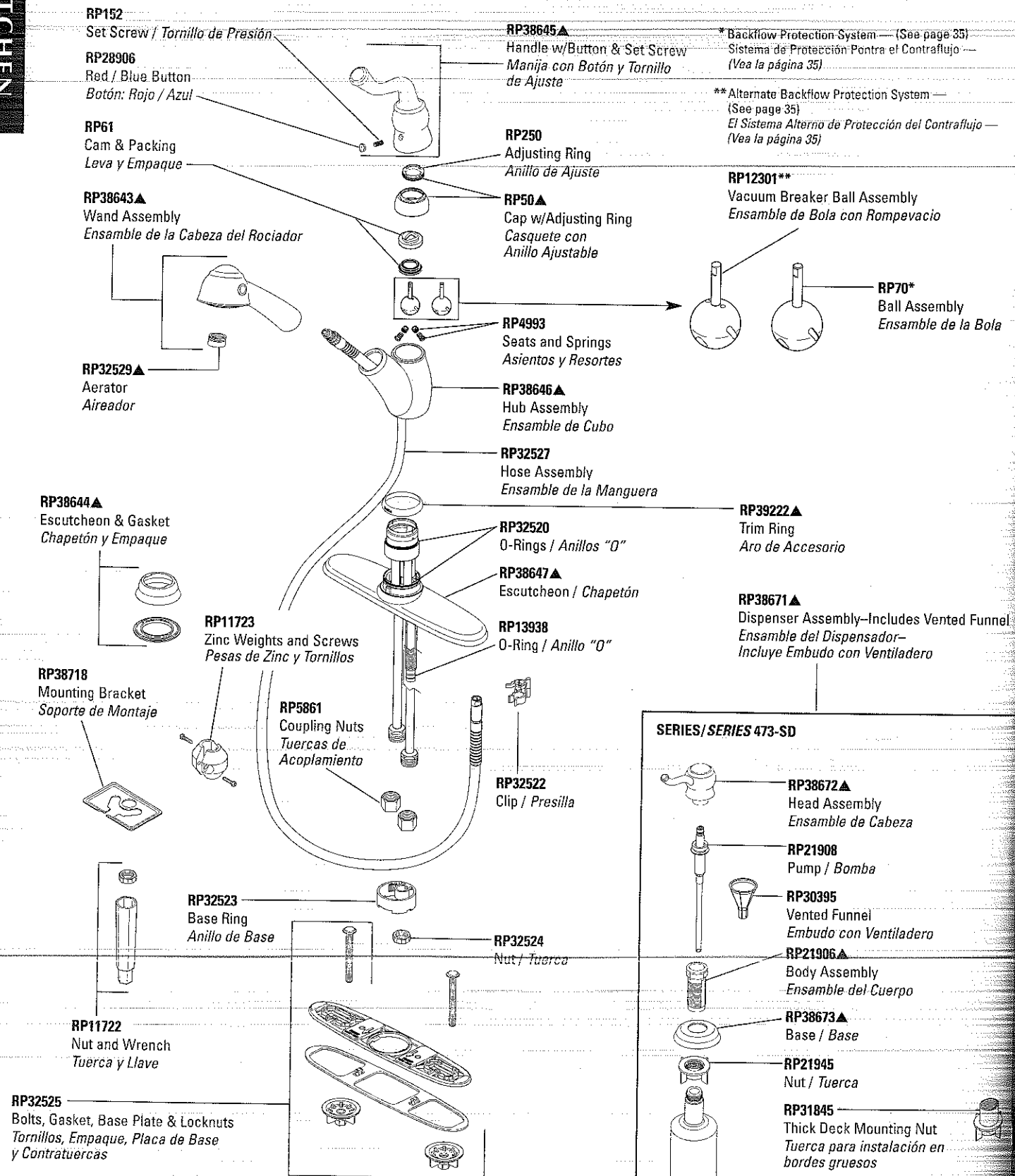

Installs on maximum 2 1/2" thick deck without additional hardware.
Se instale en bordes de un grosor máximo de 2 1/2" sin herraje adicional.

▲Specify finish / Especificue el Acabado

Single Handle Kitchen Faucets Manija de Palanca para Fregaderos

Waterfall® Pull-Out Series Models/Modelos 474 & 476 Series

KITCHEN

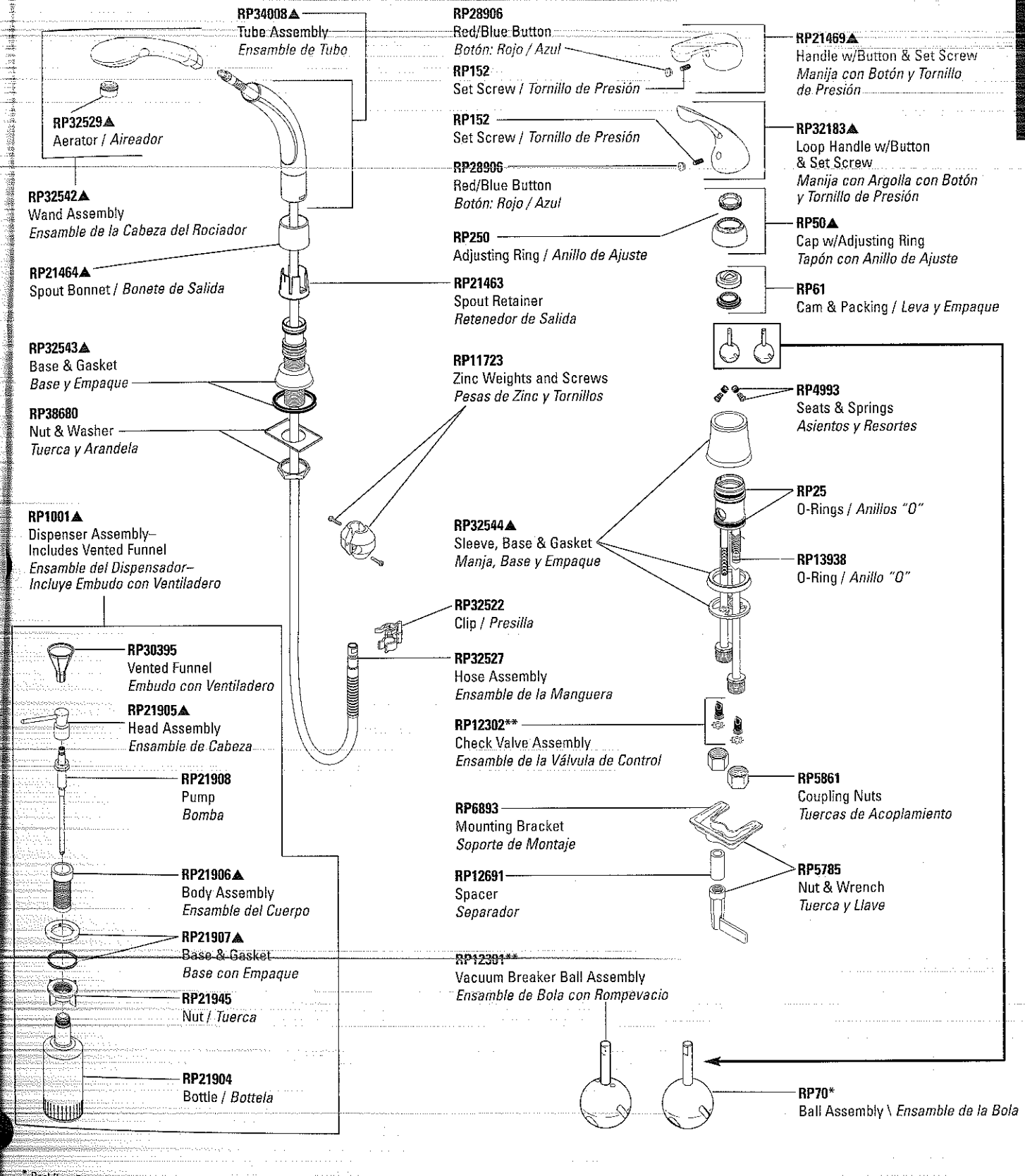

* Backflow Protection System — (See page 35) / Sistema de Protección Pontra el Contraflujo — (Vea la página 35)
 ** Alternate Backflow Protection System — (See page 35) / El Sistema Alterno de Protección del Contraflujo — (Vea la página 35)
 Installs on maximum 2 1/2" thick deck without additional hardware. / Se instale en bordes de un grosor máximo de 2 1/2" sin herraje adicional.

▲Specify finish / Especificue el Acabado

Two Handle Kitchen Faucets Llaves de Dos Manijas para Fregaderos

Signature® Series Models/Modelos 2100, 2102, 2400 & 2402 Series

KITCHEN

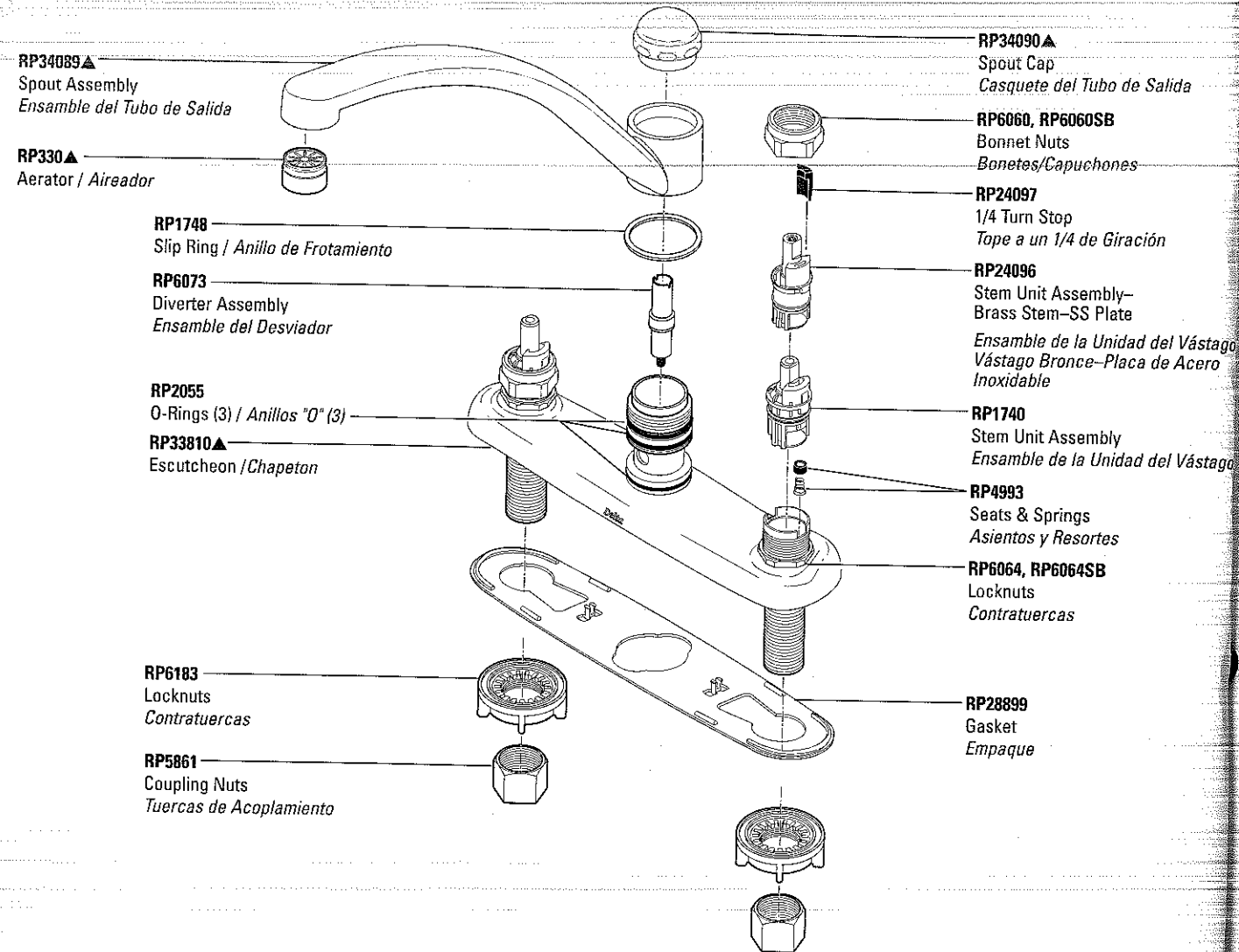

Two Handle Kitchen Faucets Llaves de Dos Manijas para Fregaderos

Signature® Series Models/Modelos 2140* & 2440* Series

KITCHEN

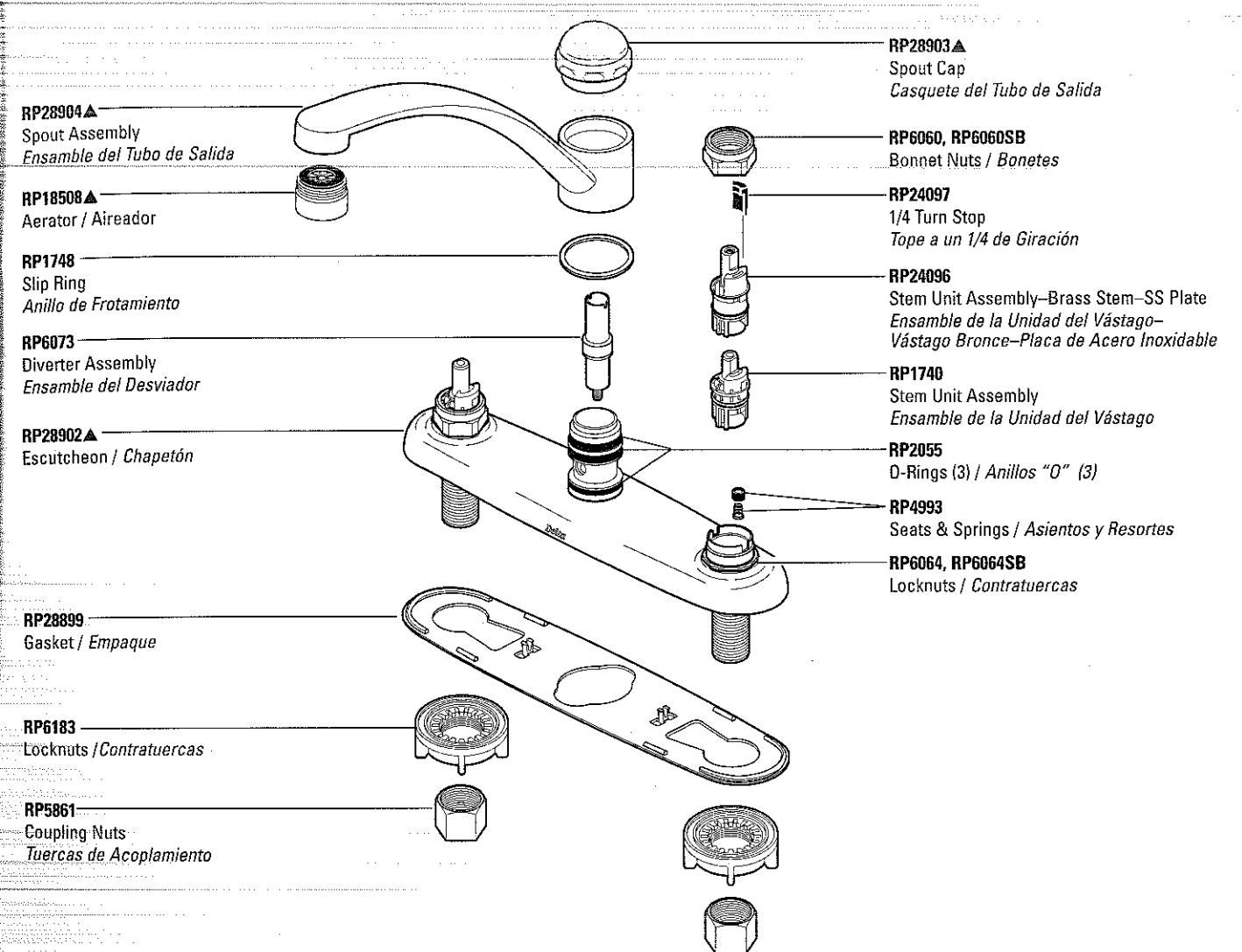

SERIES / SERIES 2400 & 2402 – Quick-Snap®

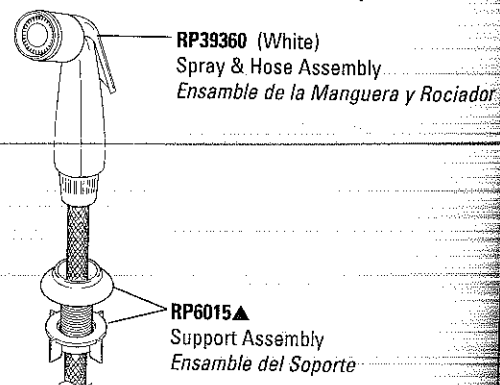

For non Quick-Snap® faucet models manufactured BEFORE September 2002, see page 34 for Vegetable Sprayers.
Para ver los modelos de llaves de agua sin Quick-Snap® fabricados ANTES de Septiembre 2002, vea la página 34 de Rociadores para Vegetales.

SERIES / SERIES 2440 – Quick-Snap®

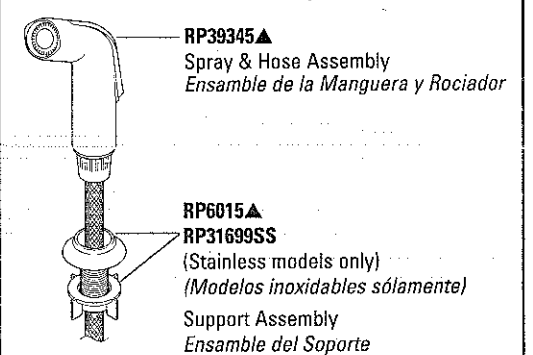

For non Quick-Snap® faucet models manufactured BEFORE September 2002, see page 34 for Vegetable Sprayers.
Para ver los modelos de llaves de agua sin Quick-Snap® fabricados ANTES de Septiembre 2002, vea la página 34 de Rociadores para Vegetales.

Refer to page 44 for handles. / Para manijas referirse a la pagina 44.

Refer to page 44 for handles. / Para manijas referirse a la pagina 44.

Two Handle Kitchen Faucets

Llaves de Dos Manijas para Fregaderos

NEO STYLE® Series Models/Modelos 2147* & 2447 Series

For Models manufactured BEFORE September 2002 / Para los modelos fabricados ANTES de Septiembre 2002

Two Handle Kitchen Faucets

Llaves de Dos Manijas para Fregaderos

NEO STYLE® Series Models/Modelos 2147* & 2447 Series

For Models manufactured AFTER September 2002 / Para los modelos fabricados DESPUÉS de Septiembre 2002

KITCHEN

KITCHEN

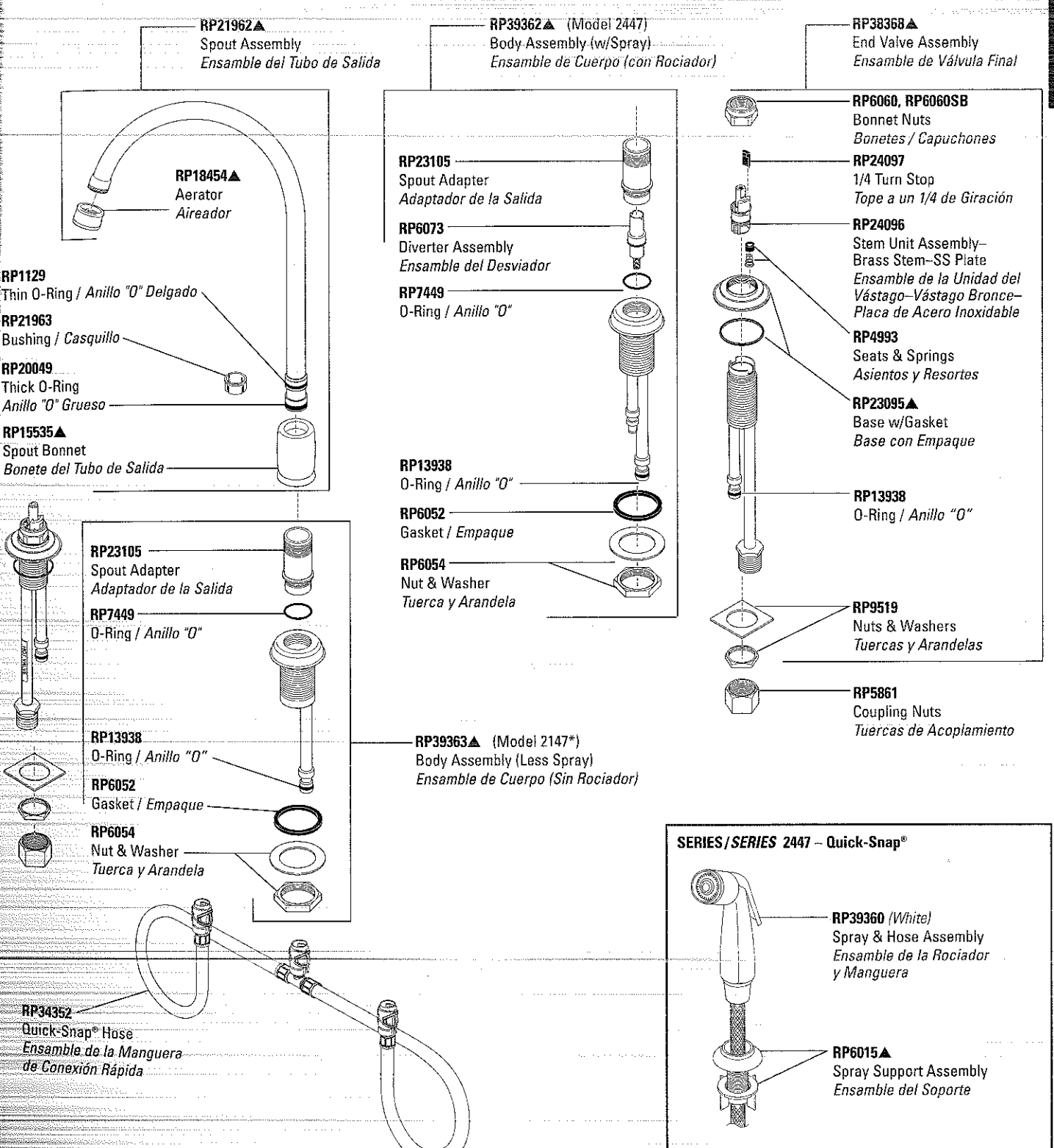
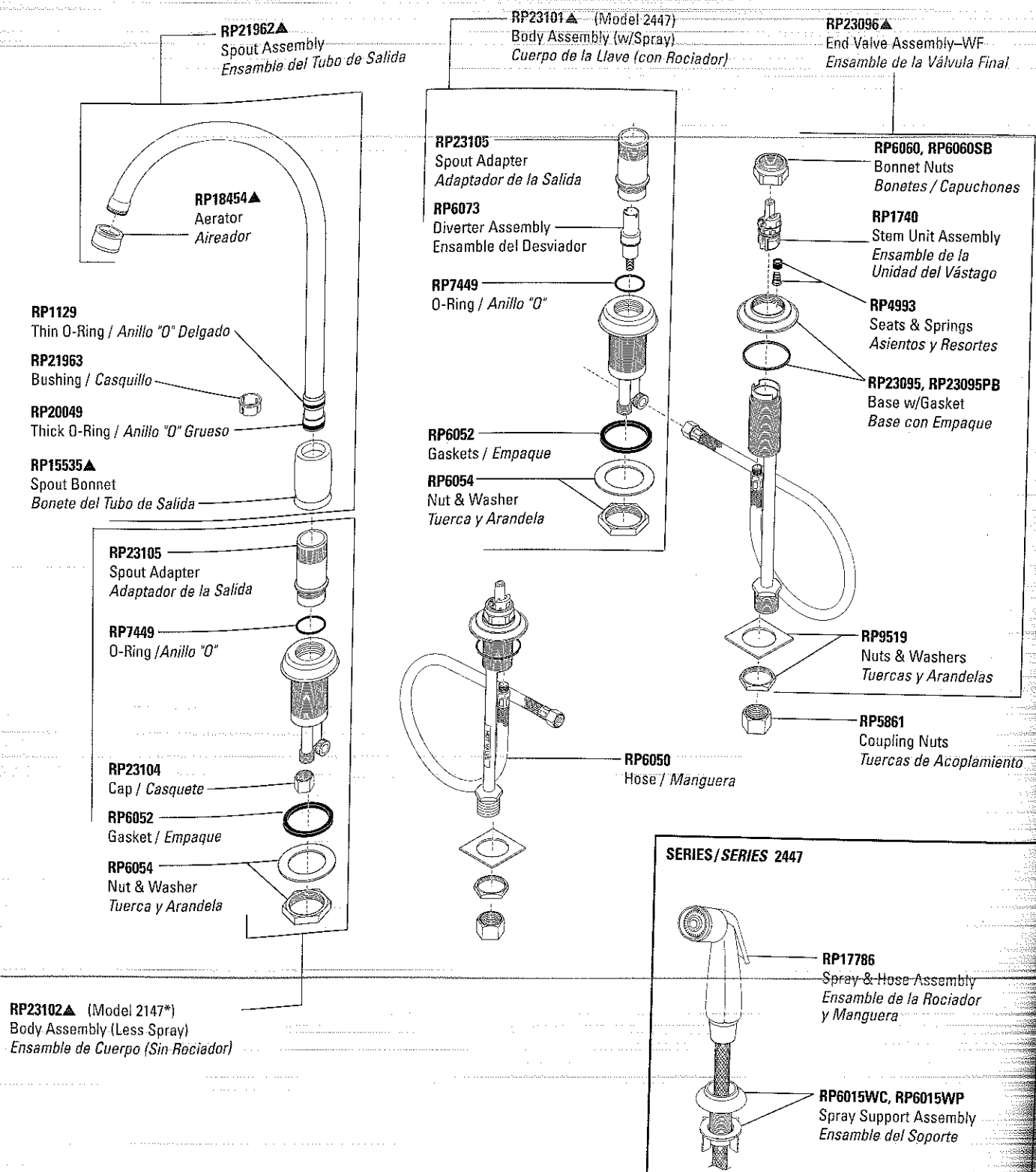

Refer to page 44 for handles. / Para manijas referirse a la página 44.

Refer to page 44 for handles. / Para manijas referirse a la página 44.

Thick tile mounting kit available as RP11053 allows installation up to 2 1/8" decks.
Las herramientas para la instalación en losas gruesas en el equipo RP11053 permiten la instalación en bordes hasta 2 1/8".

For non Quick-Snap® faucet models manufactured BEFORE September 2002, see page 34 for Vegetable Sprayers.

Para ver los modelos de llaves de agua sin Quick-Snap® fabricados ANTES de Septiembre 2002, vea la página 34 de Rociadores para Vegetales.

Two Handle Kitchen Faucets Llaves de Dos Manijas para Fregaderos

NEO STYLE® Series Models/Modelos 2167 & 2467 Series

KITCHEN

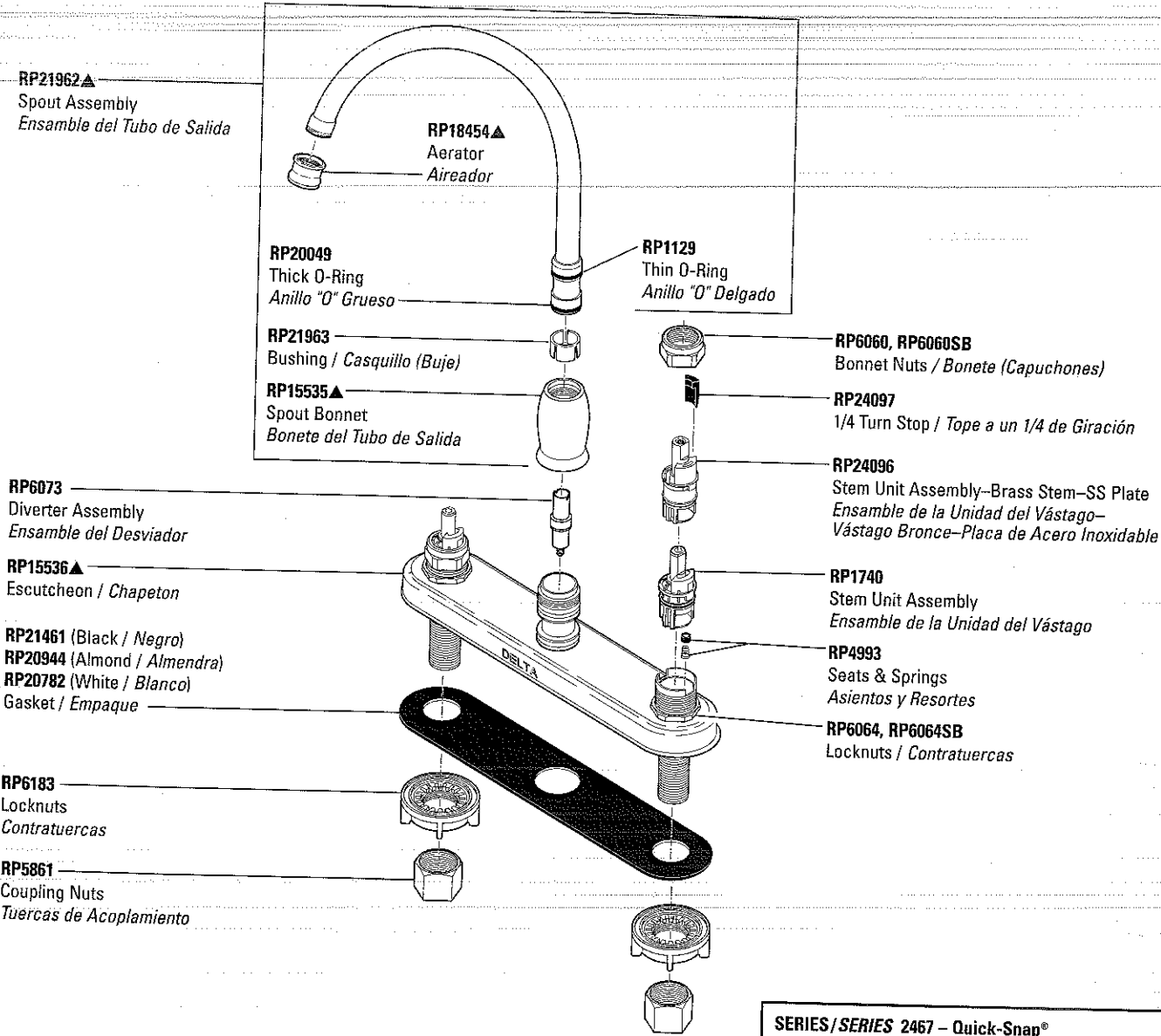

SERIES/SERIES 2467 – Quick-Snap®

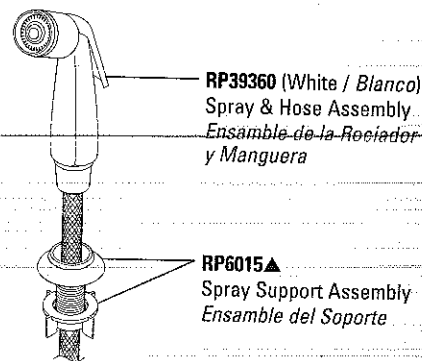

For non Quick-Snap® faucet models manufactured BEFORE September 2002, see page 34 for Vegetable Sprayers.
Para ver los modelos de llaves de agua sin Quick-Snap® fabricados ANTES de Septiembre 2002, vea la página 34 de Rociadores para Vegetales.

Refer to page 44 for handles. / Para manijas referirse a la pagina 44.

▲Specify finish / Especificque el Acabado

Two Handle Kitchen Faucets Llaves de Dos Manijas para Fregaderos

Waterfall® Series Models/Modelos 2174, 2176, 2474 & 2476 Series

KITCHEN

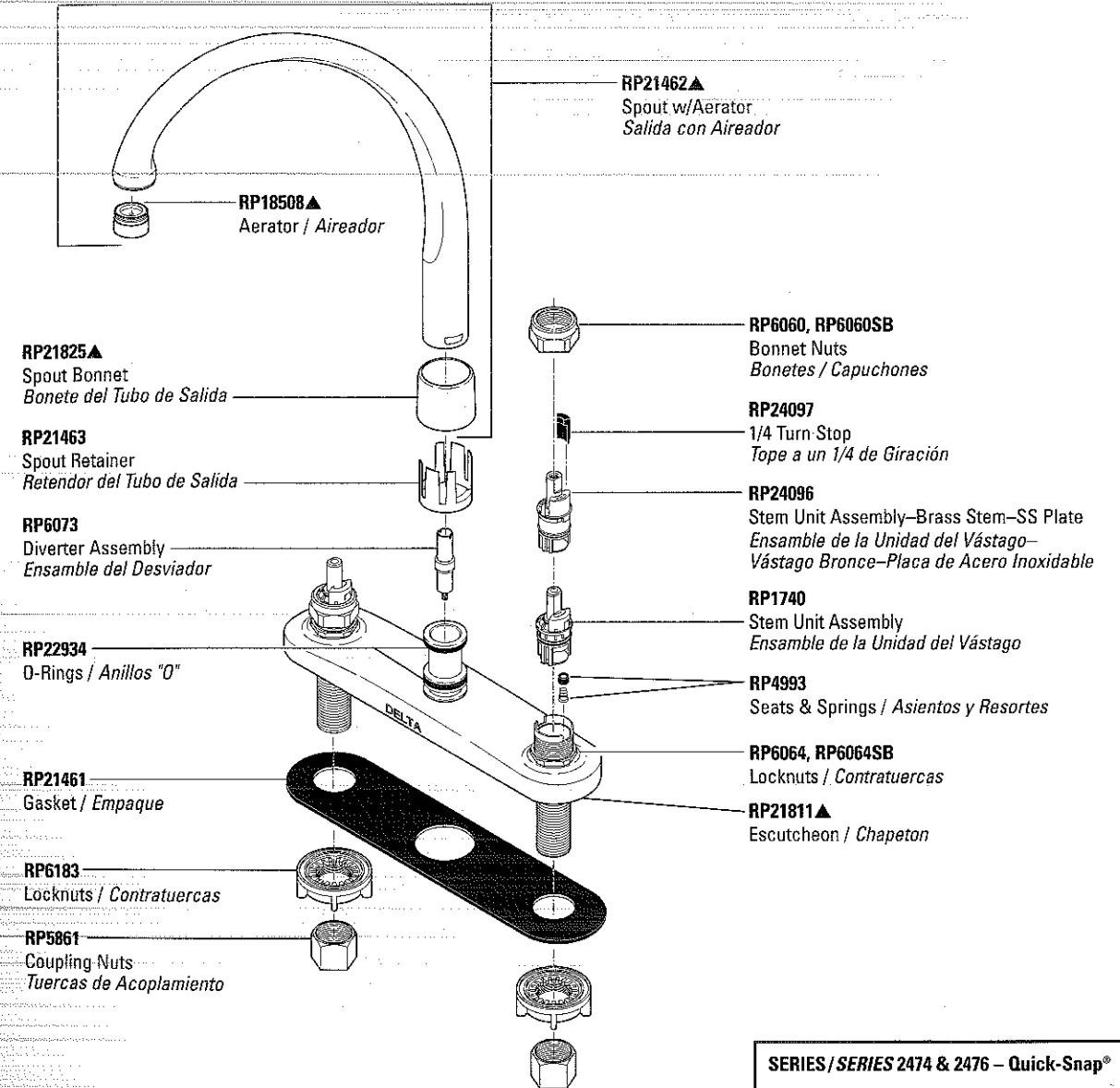

SERIES/SERIES 2474 & 2476 – Quick-Snap®

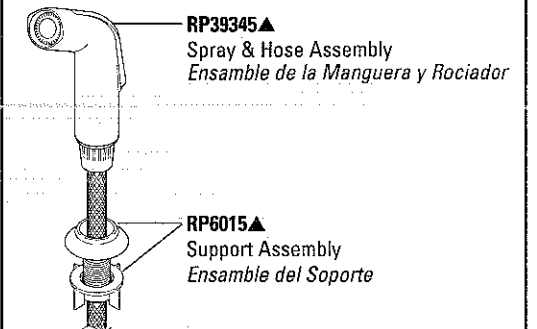

For non Quick-Snap® faucet models manufactured BEFORE September 2002, see page 34 for Vegetable Sprayers.
Para ver los modelos de llaves de agua sin Quick-Snap® fabricados ANTES de Septiembre 2002, vea la página 34 de Rociadores para Vegetales.

Refer to page 44 for handles. / Para manijas referirse a la pagina 44.

▲Specify finish / Especificque el Acabado

Two Handle Kitchen Faucets Llaves de Dos Manijas para Fregaderos

Innovations® Series Models/Modelos 2180* & 2480* Series

KITCHEN

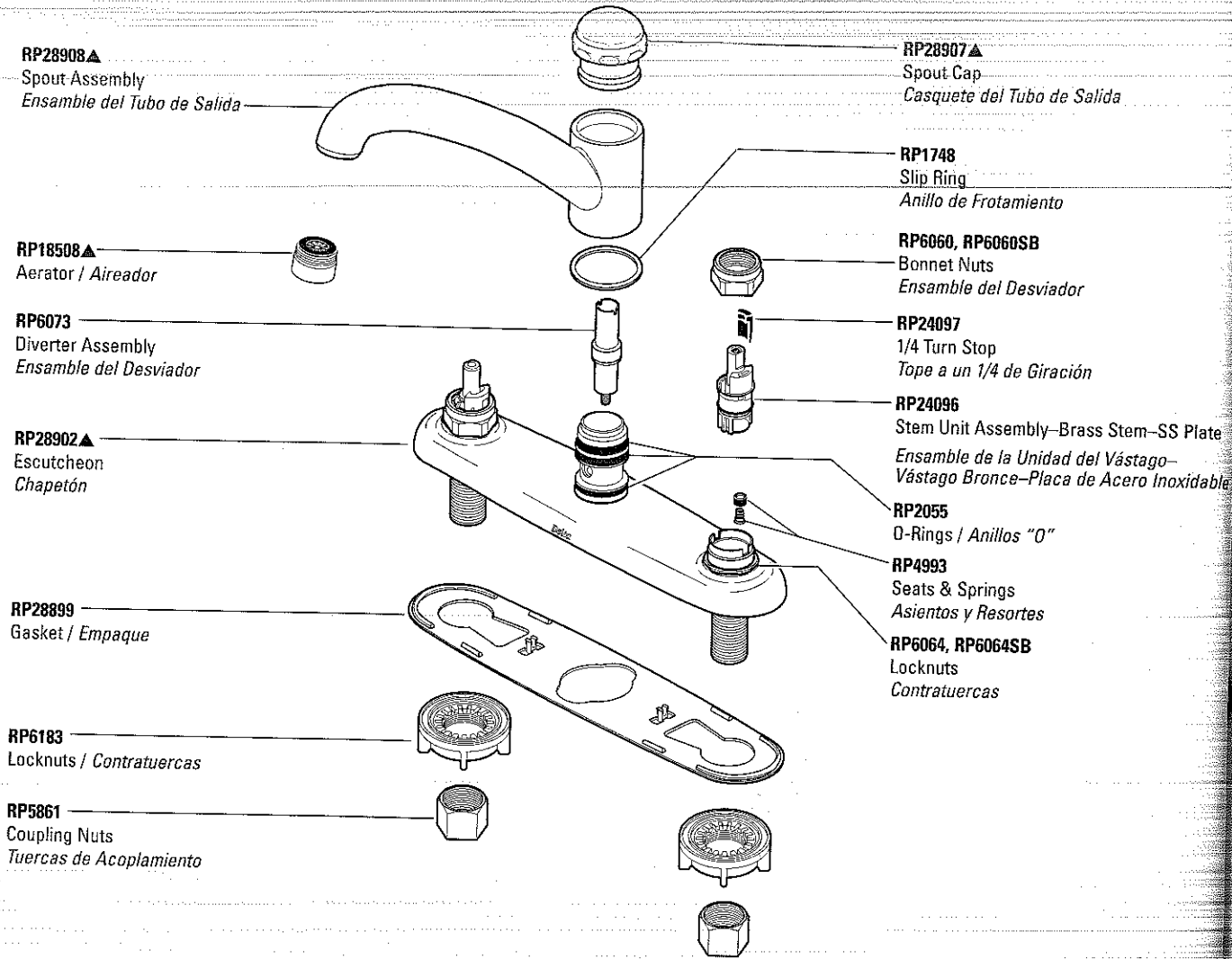

SERIES / SERIES 2480 – Quick-Snap®

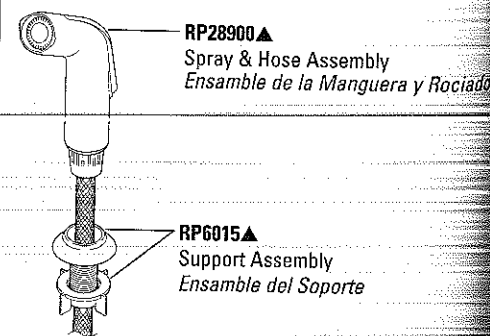

Two Handle Kitchen Faucets Llaves de Dos Manijas para Fregaderos

Victorian™ Collection Models/Modelos 2255 & 2256 Series

KITCHEN

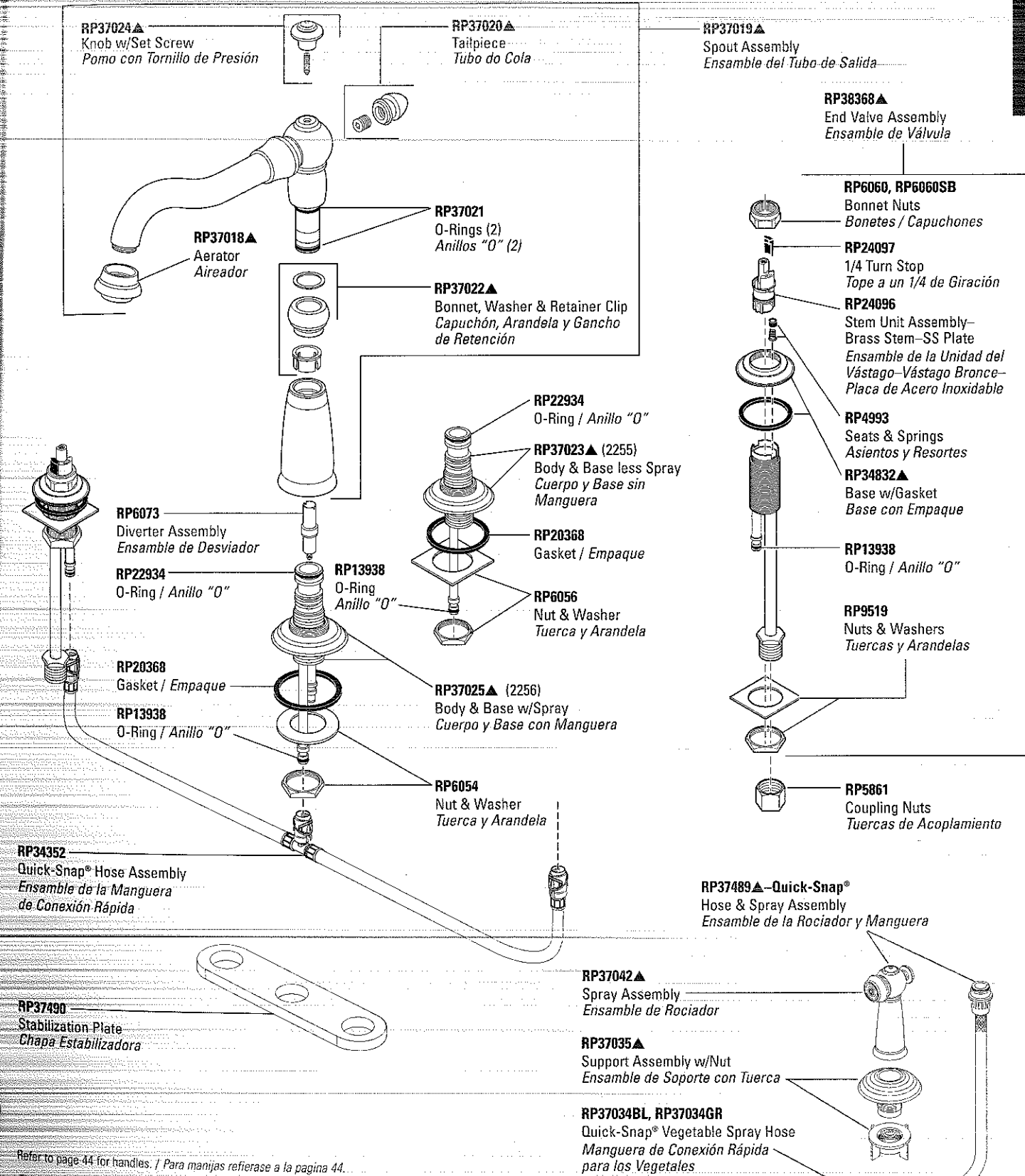

Refer to page 44 for handles. / Para manijas refierase a la pagina 44.

▲Specify finish / Especificue el Acabado

*Discontinued model—some components may not be available / Modelo descontinuado—algunos componentes pueden no estar disponibles.

Refer to page 44 for handles. / Para manijas refierase a la pagina 44.

Thick tile mounting kit available as RP11052 (2255) & RP37775 (2256) allows installation up to 2 1/8" decks.
Las herramientas para la instalación en losas gruesas en el equipo RP11052 (2255) y RP37775 (2256) permiten la instalación en bordes hasta 2 1/8".

▲Specify finish / Especificue el Acabado

Two Handle Kitchen Faucets

Llaves de Dos Manijas para Fregaderos

Waterfall® Series Models/Modelos 2274 & 2276 Series

For Models manufactured BEFORE September 2002 / Para los modelos fabricados ANTES de Septiembre 2002

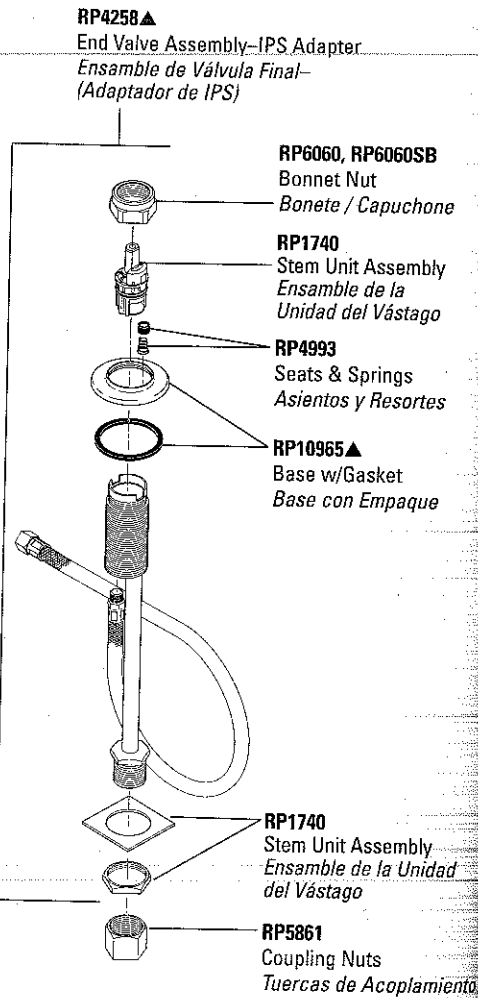
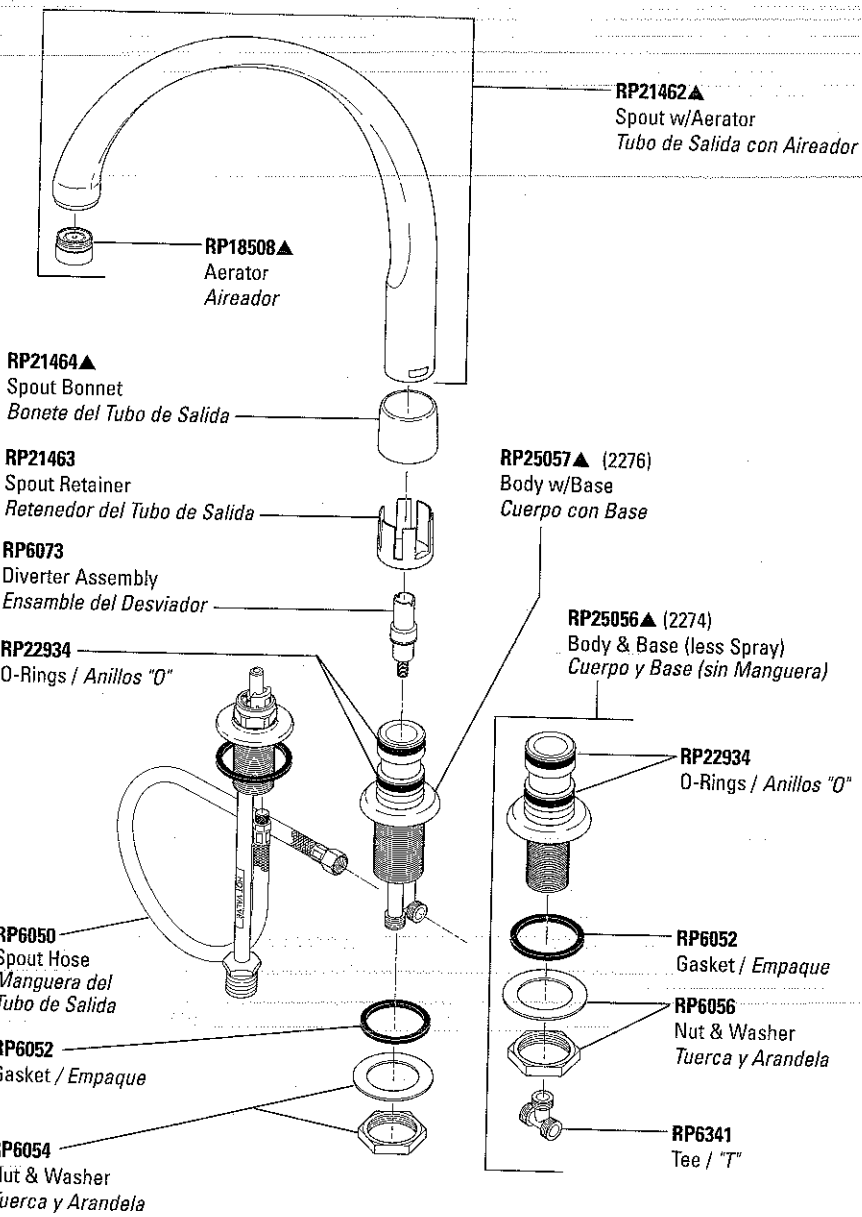

SERIES/SERIES 2276

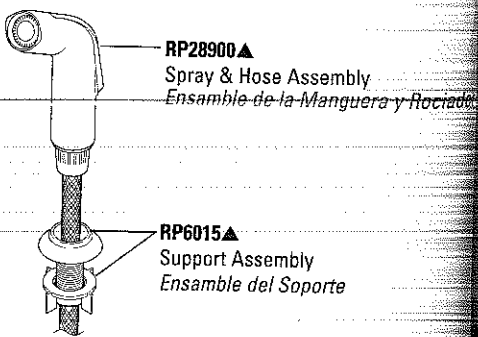

Two Handle Kitchen Faucets

Llaves de Dos Manijas para Fregaderos

Waterfall® Series Models/Modelos 2274 & 2276 Series

For Models manufactured AFTER September 2002 / Para los modelos fabricados DESPUÉS de Septiembre 2002

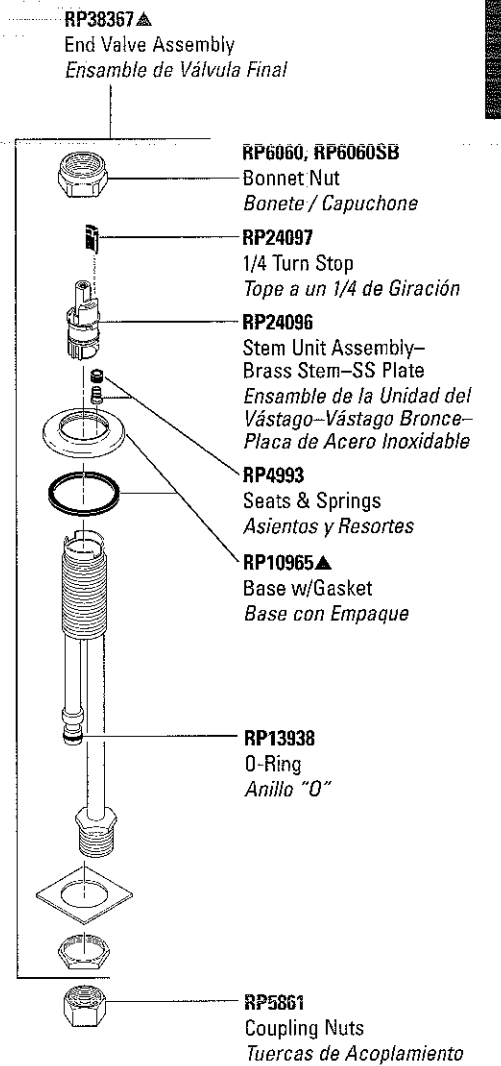
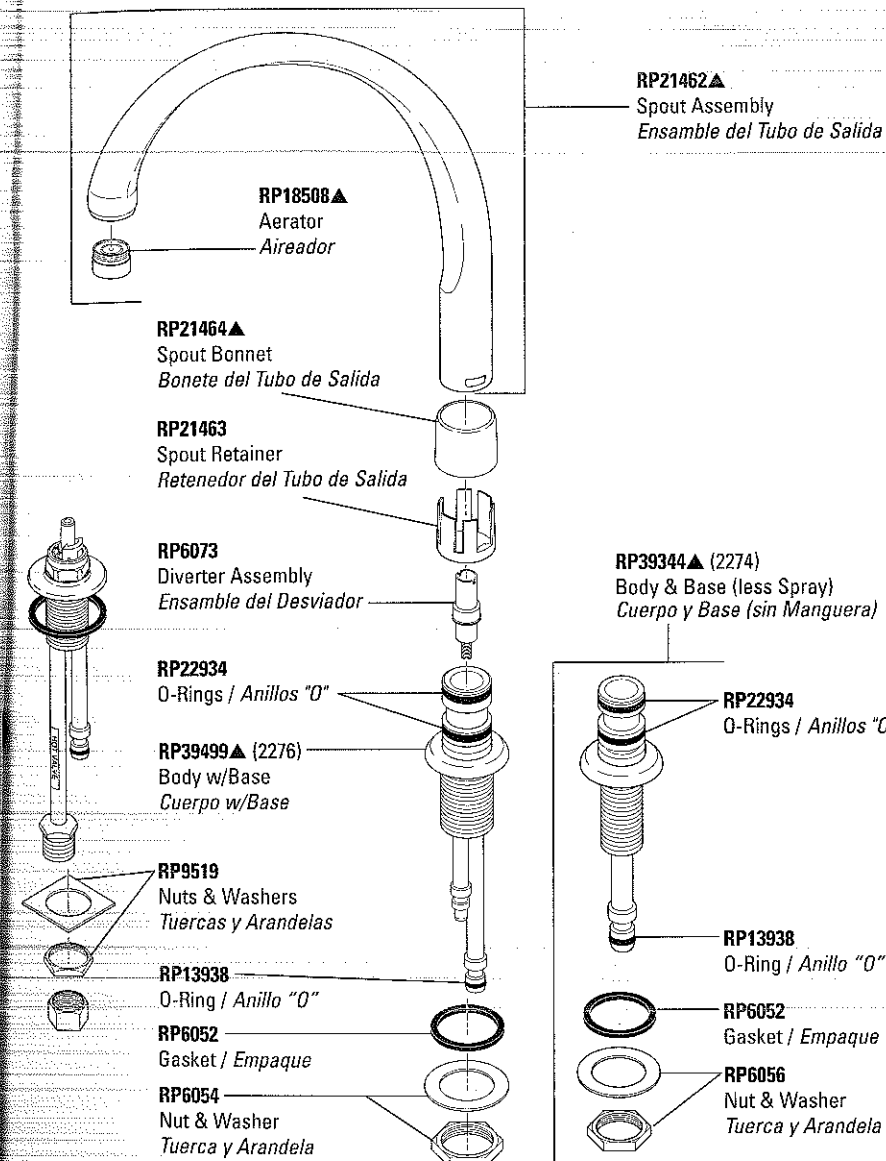

SERIES/SERIES 2276 - Quick-Snap®

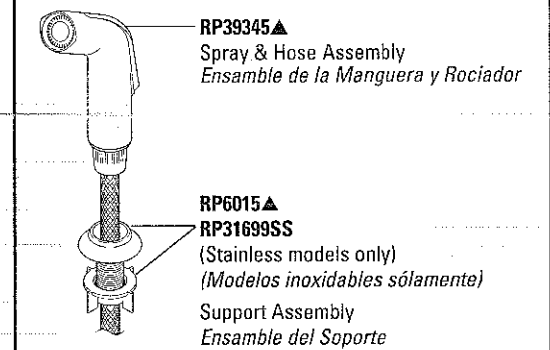

Refer to page 44 for handles. / Para manijas referirse a la página 44.

Thick tile mounting kit available as RP11053 allows installation up to 2 1/8" decks.

Las herramientas para la instalación en losas gruesas en el equipo RP11053 permiten la instalación en bordes hasta 2 1/8".

Refer to page 44 for handles. / Para manijas referirse a la página 44.

Thick tile mounting kit available as RP11053 allows installation up to 2 1/8" decks.

Las herramientas para la instalación en losas gruesas en el equipo RP11053 permiten la instalación en bordes hasta 2 1/8".

Kitchen Vegetable Sprayer Options

Opciones de Rociadores de Cocinas para Vegetales

Additional Kitchen Faucet Information

Información Adicional Sobre Llaves de Agua para Concinas

KITCHEN

Non Quick-Snap® Models

RP6011 Black / Negro
 Spray & Hose Assembly—Chrome Band
 Ensamble de la Manguera y Rociador—
 Anillo de Cromo

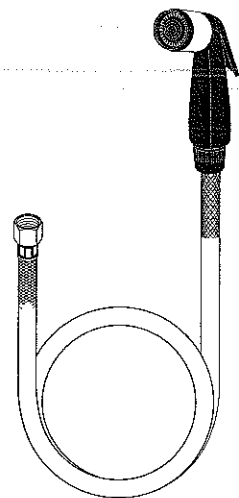

RP17781 White / Blanco
 Spray & Hose Assembly—Chrome Band
 Ensamble de la Manguera y Rociador—
 Anillo de Cromo

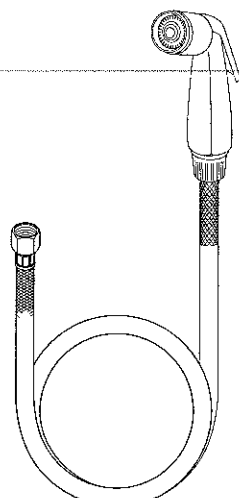

RP17786 White / Blanco
RP17786BS Biscuit / Beige
 Spray & Hose Assembly—No Band
 Ensamble de la Manguera y Rociador—
 Sin Anillo

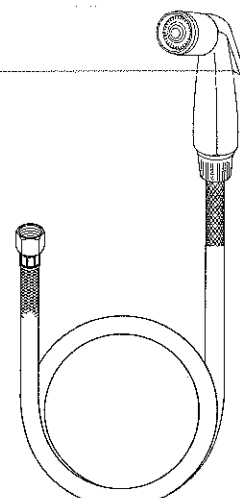

RP28900▲
 Spray & Hose Assembly
 Ensamble de la Manguera y Rociador

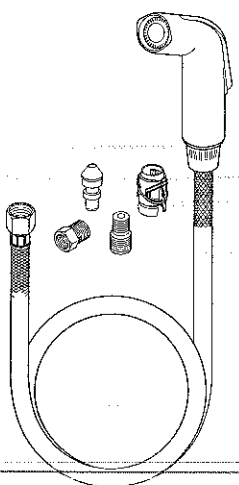

RP26878 Black / Negro
 Spray & Hose Assembly—6'
 Ensamble de la Manguera y Rociador—6'

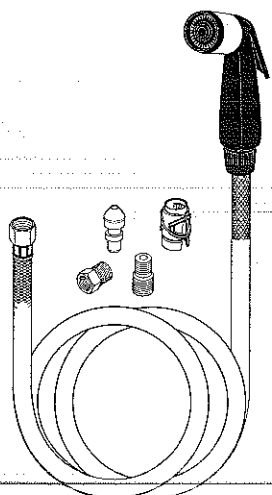

RP26879 Black / Negro
 Spray & Hose Assembly—8'
 Ensamble de la Manguera y Rociador—8'

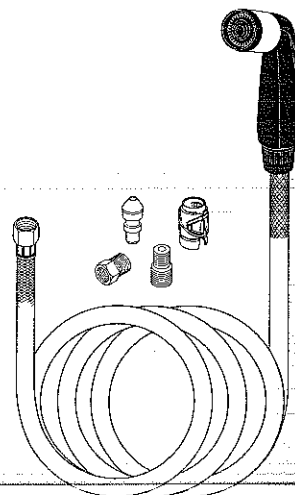

If unsure if your faucet is Quick-Snap® and was manufactured BEFORE September 2002, please order: **RP31612▲**
 Si no está seguro si la llave de agua es Quick-Snap® y fue fabricada ANTES de Septiembre 2002, por favor ordene: **RP31612▲**

RP31612▲
 Spray & Hose Assembly—Includes Quick-Snap® Hose, Spray Support & Adapter
 Ensamble de la Manguera y Rociador—Incluye Manguera, Soporte de Rociador
 y Adaptador Quick-Snap®

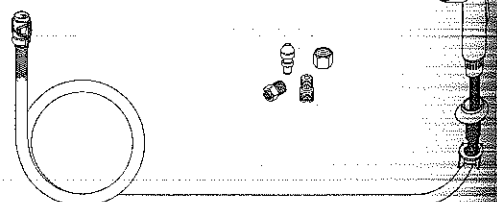

Backflow Protection System

Your Delta Faucet pull-out spout incorporates a backflow protection system that has been tested to be in compliance with ASME A112.18.3, CSA B125 and ASME A112.18.1. It incorporates two certified check valves in series, which operate independently and are integral, non-serviceable parts of the wand assembly.

Sistema de Protección Pontra el Contraflujo

Su llave de agua tipo deslizable Delta tiene un sistema de protección contra el contraflujo, incorporado, que ha sido probado para cumplir con los requisitos de ASME A112.18.3, CSA B125 y ASME A112.18.1. Este incorpora en la pieza de mano dos válvulas de retención o checadoras certificadas en una serie, las cuales operan independientemente y son piezas integrantes que no requieren servicio.

Alternate Backflow Protection System

If your local plumbing code requires faucets with pull-out spouts to include an atmospheric vacuum breaker, the RP70 standard ball that is installed in the fitting, as shipped, MUST be replaced with RP12301 (vacuum breaker ball) and hot & cold inlet checks (RP12302) must be installed.

El Sistema Alterno de Protección del Contraflujo

Si los códigos de su plomería local requieren que las llaves de agua con el tubo de salida de agua deslizable incluyan un rompedor de vacío atmosférico, la bola RP70 estándar que se instala en el mecanismo, como enviada, DEBE ser reemplazada por la pieza RP12301 (bola rompedora de vacío) y se deben instalar los topes de agua caliente y fría (RP12302).

KITCHEN

Single Handle Bar Faucets Manija de Palanca para Bares

Waterfall® Series Model/Modelo 190 Series

For Models manufactured BEFORE September 2002 / Para los modelos fabricados ANTES de Septiembre 2002

BAR/PREP

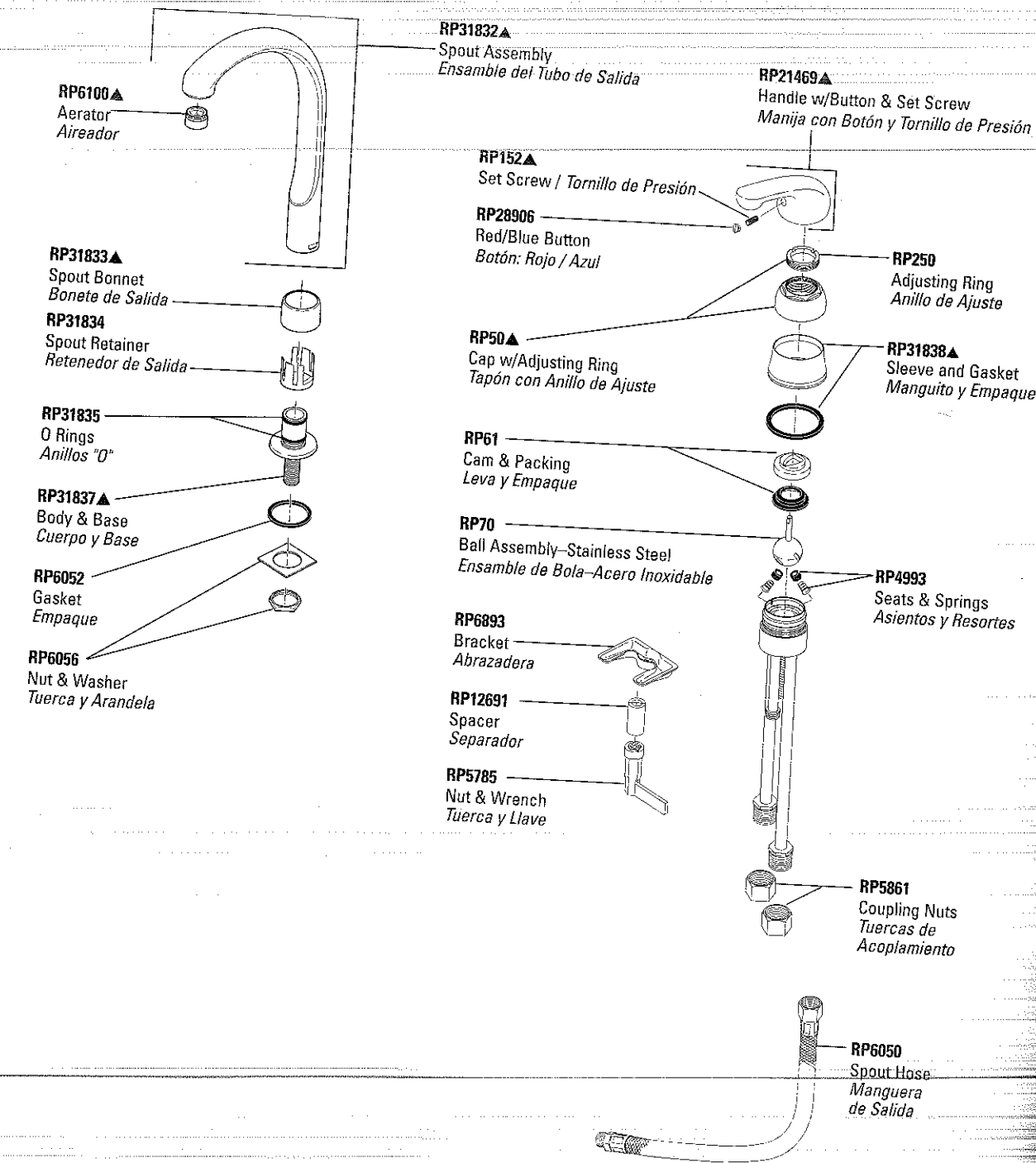

Single Handle Bar Faucets Manija de Palanca para Bares

Waterfall® Series Model/Modelo 190 Series

For Models manufactured AFTER September 2002 / Para los modelos fabricados DESPUÉS de Septiembre 2002

BAR/PREP

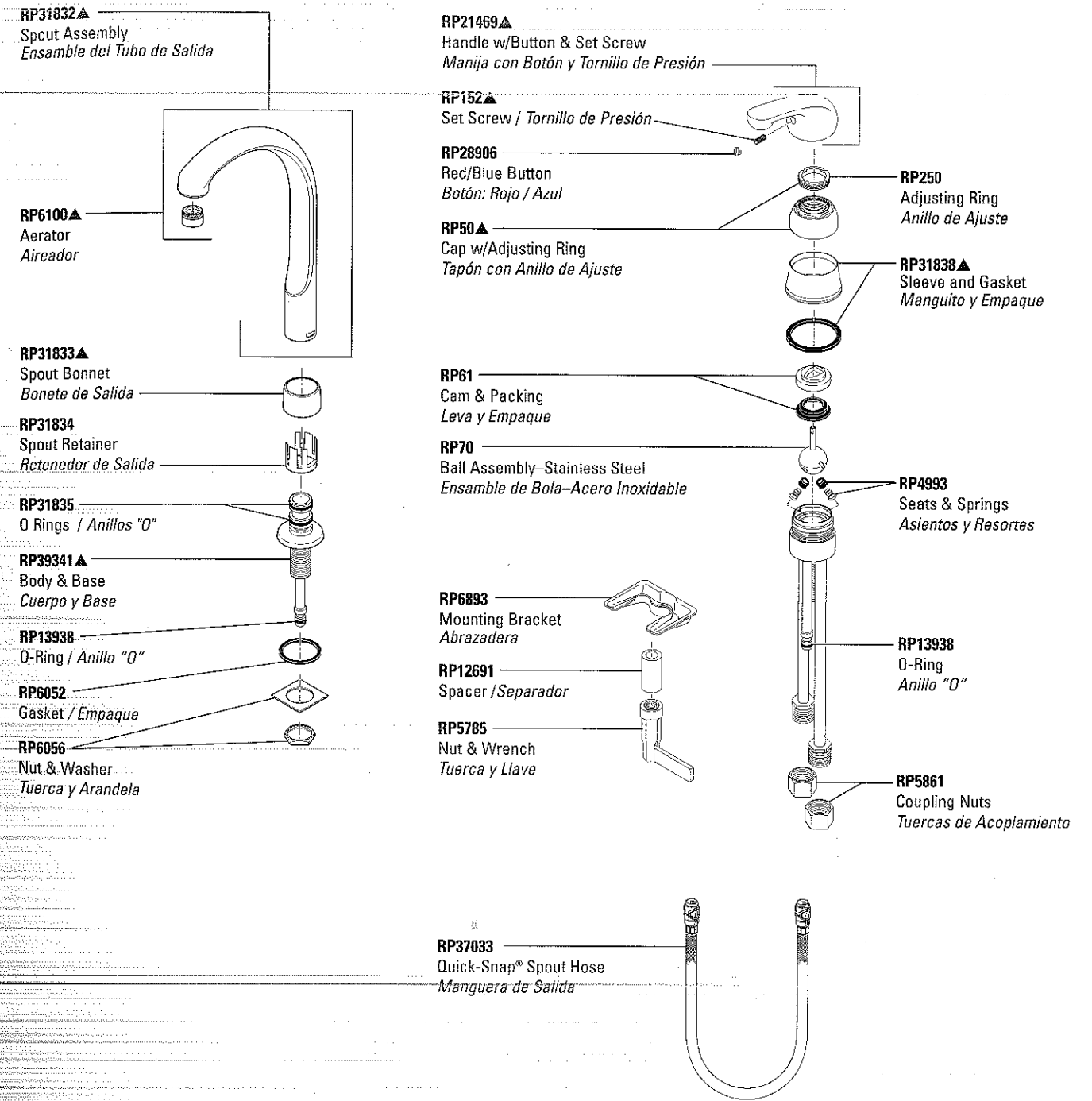

Thick tile mounting kit available as RP32638 allows installation up to 2 1/2" decks. / Las herramientas para la instalación en losas gruesas en el equipo RP32638 permiten la instalación en bordes hasta 2 1/2".

▲Specify finish / Especificque el Acabado

Thick tile mounting kit available as RP32638 allows installation up to 2 1/2" decks. / Las herramientas para la instalación en losas gruesas en el equipo RP32638 permiten la instalación en bordes hasta 2 1/2".

▲Specify finish / Especificque el Acabado

Single Handle Bar Faucets Manija de Palanca para Bares

MICHAEL GRAVES
COLLECTION

Model/Modelo 198 Series

BAR/PREP

RP40377▲
Spout Assembly
Ensamble del Tubo de Salida

RP40372▲
Swivel Head Aerator
Areador de cabeza giratoria

RP37021
O Rings / Anillos "O"

RP40371▲
Bonnet, Washer & Retainer Clip
Capuchón, Arandela y Clip Retenedor

RP21961
Spout Retainer Clip
Clip retenedor para el surtidor

RP40375▲
Body & Sleeve
Cuerpo Interno y Manga

RP13938
O-Ring / Anillo "O"

RP23946
Gasket / Empaque

RP38718
Mounting Bracket / Abrazadera

RP11722
Nut & Wrench
Tuerca y Llave

RP37033
Quick-Snap® Spout Hose
Manguera de Salida

RP40649
Set Screw
Tornillo de Presión

RP28906
Red/Blue Button
Botón Rojo / Azul

RP40373▲
Handle w/Button & Set Screw
Manija con Botón y Tornillo de Presión

RP250
Adjusting Ring / Anillo de Ajuste

RP50▲
Cap w/Adjusting Ring
Tapón con Anillo de Ajuste

RP40374▲
Sleeve / Manguito

RP6052
Gasket / Empaque

RP61
Cam & Packing / Leva y Empaque

RP70
Ball Assembly—Stainless Steel
Ensamble de Bola—Acero Inoxidable

RP4993
Seats & Springs
Asientos y Resortes

RP13938
O-Ring / Anillo "O"

RP38718
Mounting Bracket / Abrazadera

RP11722
Nut & Wrench
Tuerca y Llave

RP5861
Coupling Nuts
Tuercas de Acoplamiento

Two Handle Bar Faucets Manijas de Palanca para Bares

Victorian™ Collection Model/Modelo 2155 Series

BAR/PREP

RP37029▲
Finial with Set Screw
Pomo con Tornillo

RP37026▲
Spout Assembly
Ensamble del Tubo de Salida

RP34345▲
Aerator / Aireador

RP24097
1/4 Turn Stop
Parada (Tope) a un 1/4 de Rotación

RP4993
Seats & Springs
Asientos y Resortes

RP37027▲
Tailpiece / Tubo de Cola de Salida

RP37021
O-Rings / Anillos "O"

RP37028▲
Bonnet with Washer and Retainer Clip
Capuchón con Arandela y Gancho de Retención

RP6060
Bonnet Nuts
Bonetes / Capuchones

RP25513
Stem Unit Assembly—Brass Stem—SS Plate
Ensamble de la Unidad del Vástago—Vástago Bronce—Placa de Acero Inoxidable

RP6064, RP6064SB
Locknuts
Contratuercas

RP34347
Gasket / Empaque

RP6183
Locknuts / Contratuercas

RP5861
Coupling Nuts
Tuercas de Acoplamiento

Two Handle Bar Faucets Manijas de Palanca para Bares

Classic Series - Model/Modelo 2170, 2171 & 2172 Series

BAR/PREP

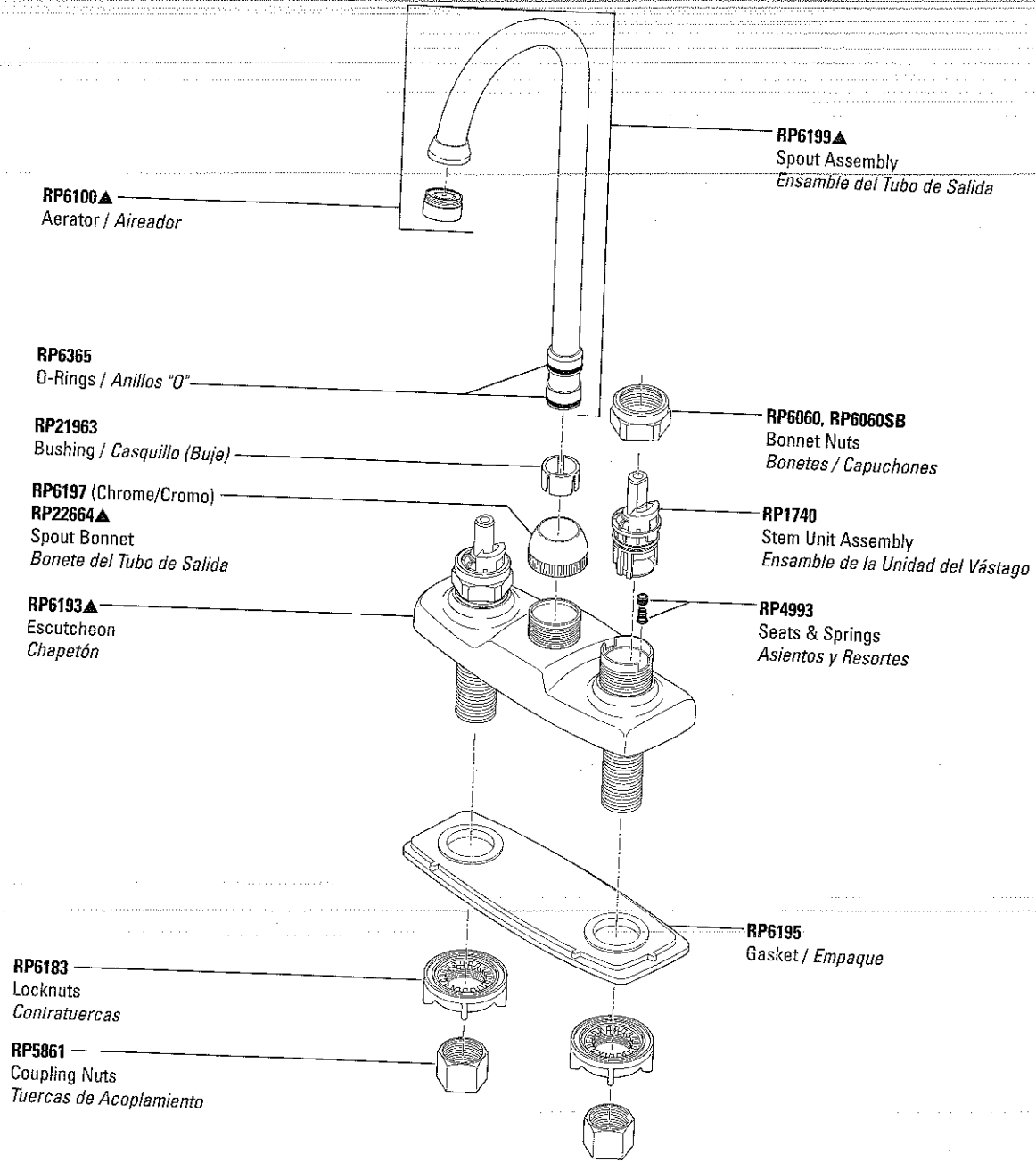

Refer to page 44 for Handles. / Para manijas referirse a la página 44.

▲Specify finish / Especificar el Acabado

Two Handle Bar Faucets Manijas de Palanca para Bares

NEO STYLE® Model/Modelo 2177 Series

BAR/PREP

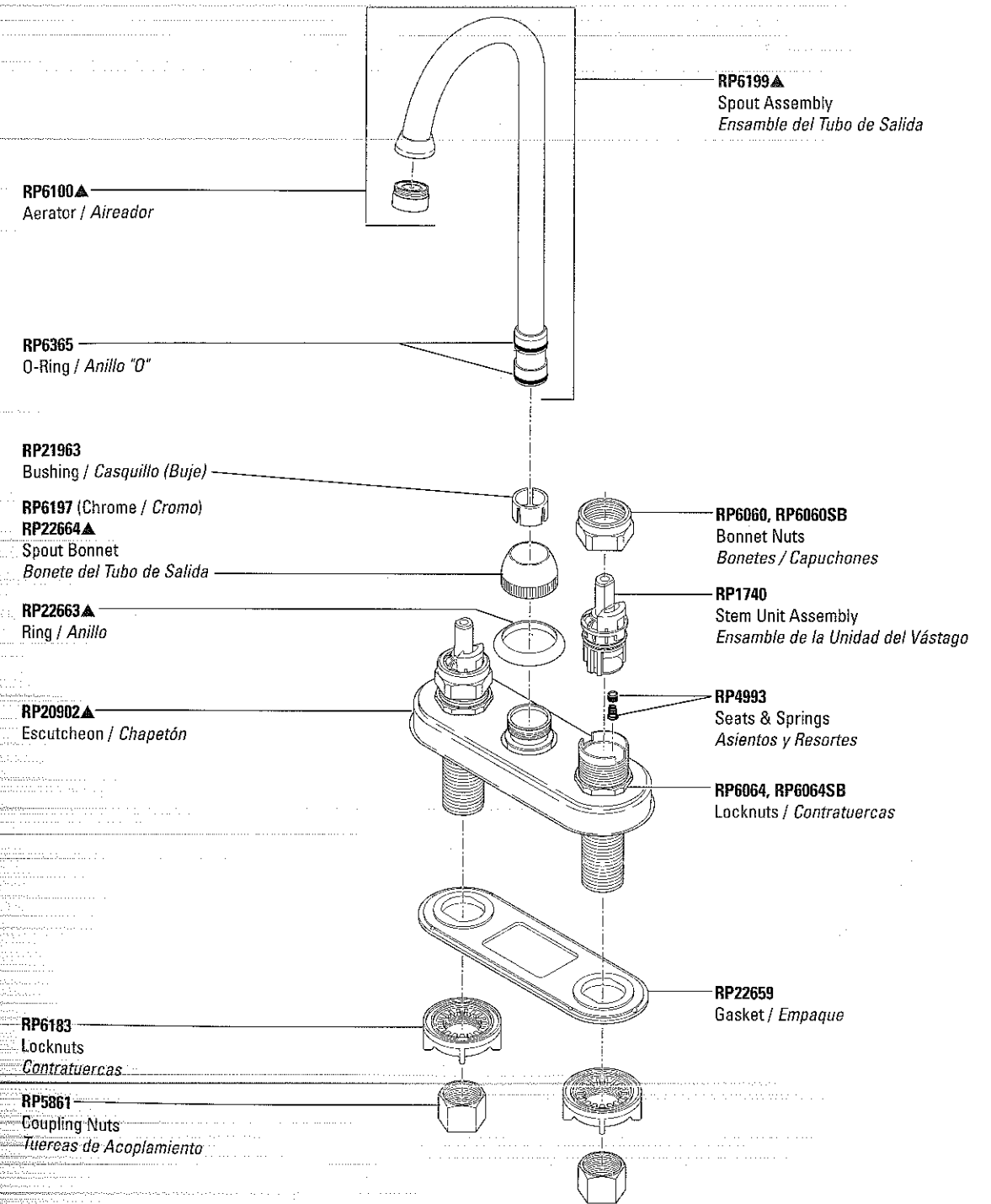

Refer to page 44 for Handles. / Para manijas referirse a la página 44.

▲Specify finish / Especificar el Acabado

Two Handle Bar Faucets Manijas de Palanca para Bares

Classic Series Models/Modelos 2178 & 2179 Series

BAR/PREP

RP28910
Spout Assembly
Ensamble del Tubo de Salida

RP25077
Aerator / Aireador

RP28912
Retaining Ring
Anillo de Retención

RP6365
O-Ring / Anillo "O"

RP28913
Spout Bonnet
Bonete del Tubo de Salida

RP28919
Escutcheon / Chapetón

RP6183
Locknuts
Contratuercas

RP5861
Coupling Nuts
Tuercas de Acoplamiento

RP6060, RP6060SB
Bonnet Nuts
Bonetes / Capuchones

RP1740
Stem Unit Assembly
Ensamble de la Unidad del Vástago

RP4993
Seats & Springs
Asientos y Resortes

RP6064
Locknuts
Contratuercas

Two Handle Bar Faucets Manijas de Palanca para Bares

Waterfall® Series Model/Modelo 2190 Series

BAR/PREP

RP6100▲
Aerator / Aireador

RP31832▲
Spout Assembly
Ensamble del Tubo de Salida

RP31833▲
Spout Bonnet
Bonete del Tubo de Salida

RP31834
Spout Retainer
Retenador del Tubo de Salida

RP31835
O-Rings / Anillos "O"

RP22659
Gasket / Empaque

RP6183
Locknuts
Contratuercas

RP5861
Coupling Nuts
Tuercas de Acoplamiento

RP6060, RP6060SB
Bonnet Nuts
Bonetes / Capuchones

RP24097
1/4 Turn Stop
Tope a un 1/4 de Giración

RP24096
Stem Unit Assembly—Brass Stem—SS Plate
Ensamble de la Unidad del Vástago—
Vástago Bronce—Placa de Acero Inoxidable

RP4993
Seats & Springs
Asientos y Resortes

RP6064, RP6064SB
Locknuts
Contratuercas

RP31836▲
Escutcheon
Chapetón

Refer to page 44 for Handles. / Para manijas referirse a la página 44.

▲Specify finish / Especificar el Acabado

Refer to page 44 for Handles. / Para manijas referirse a la página 44.

▲Specify finish / Especificar el Acabado

Kitchen/Bar Faucet Handles and Accents

Manijas y Accesorios para la Llave de Agua Auxiliar de la Cocina

KITCHEN/BAR

H21, H21PB
Clear Knob Handles w/Buttons & Screws
Perillas Transparente con Botones y Tornillos

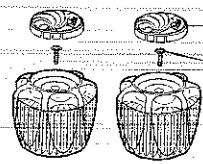

RP18373, RP18373PB
Button Set (Red/Blue Indicators)
Botones (Indicadores: Rojo/Azul)
RP5885
Screws
Tornillos

H41, H41PB
Clear Knob Handles w/Buttons & Screws-Clear
Perillas Transparente con Botones y Tornillos

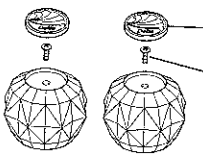

RP18373, RP18373PB
Button Set (Red/Blue Indicators)
Botones (Indicadores: Rojo/Azul)
RP5885
Screws
Tornillos

H28
Metal Blade Handles w/Buttons & Screws
Manijas de Manga de Metal con Botones y Tornillos

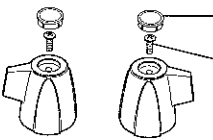

RP2412
Button Set
Botones
RP5885
Screws
Tornillos

H48
Metal Knob Handles w/Buttons & Screws
Perillas de Metal con Botones y Tornillos

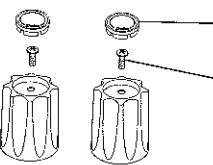

RP19659
Button Set (Red/Blue Indicators)
Botones (Indicadores: Rojo/Azul)
RP5885
Screws
Tornillos

H22▲
Standard Lever Handles w/Screws
Manijas Estilo Palancas Estándares con Tornillos

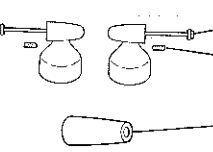

RP26851▲
Spindle/Husillo
RP25620
Set Screws/Tornillos de Ajuste
A22▲
Handle Accents
Acentos para Manijas

H24▲
Innovations® Lever Handles w/Screws
Manijas Estilo Palanca Innovations® con Tornillos

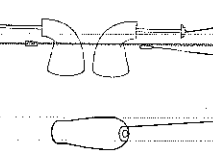

RP26852▲
Spindle/Husillo
RP25620
Set Screws/Tornillos de Ajuste
A24▲
Handle Accents
Acentos para Manijas

H25▲
Neo Style® Lever Handles w/Screws
Manijas Estilo Palanca Neo Style® con Tornillos

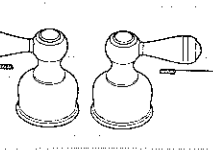

RP25620
Set Screws/Tornillos de Ajuste

H26▲
Neo Style® Metal Cross Handles w/Screws
Manijas de Metal en Forma de Cruz Neo Style® con Tornillos

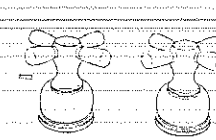

RP25620
Set Screws/Tornillos de Ajuste

H27▲
Neo Style® Porcelain Cross Handles w/Screws
Manijas de Porcelana en Forma de Cruz Neo Style® con Tornillos

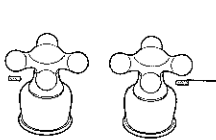

RP25620
Set Screws/Tornillos de Ajuste

H46▲
Neo Style® Metal Cross Handles w/Screws
Manijas de Metal en Forma de Cruz Neo Style® con Tornillos

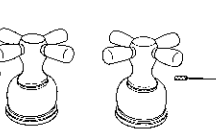

RP25620
Set Screws/Tornillos de Ajuste

H212▲
Traditional Porcelain Lever Handles w/Screws
Manijas Tradicionales Estilo Palanca de Porcelana con Tornillos

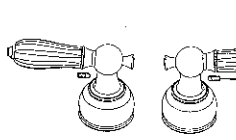

RP25620
Set Screws/Tornillos de Ajuste

H215▲
Traditional Metal Lever Handles w/Screws
Manijas Tradicionales Estilo Palanca de Metal con Tornillos

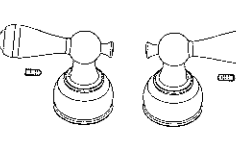

RP25620
Set Screws/Tornillos de Ajuste

H216▲
Victorian™ Lever Handles w/Screws
Manijas Estilo Palanca Victorian™ con Tornillos

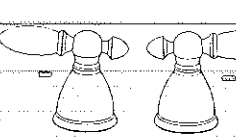

RP25620
Set Screws/Tornillos de Ajuste

Installation Aids/Repair Kits

Herramientas para la Instalación/Herramientas de Repuesto

RP001▲
Soap/Lotion
Dispenser Assembly
Ensamble del Surtidor
de Jabón/Loción

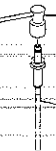

RP21905▲
Head Assembly
Ensamble de Cabeza

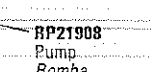

RP21908
Pump
Bomba

RP21906▲
Body Assembly
Ensamble del Cuerpo

RP21945
Nut
Tuerca

RP21904
Bottle
Botella

RP37039▲
Soap/Lotion
Dispenser Assembly
Ensamble del Surtidor
de Jabón/Loción

RP37038▲
Head Assembly
Ensamble de Cabeza

RP21908
Pump
Bomba

RP21906▲
Body Assembly
Ensamble del Cuerpo

RP37037▲
Base
Base

RP21945
Nut
Tuerca

RP21904
Bottle
Botella

RP38671▲
Soap/Lotion
Dispenser Assembly
Ensamble del Surtidor
de Jabón/Loción



RP38672▲
Head Assembly
Ensamble de Cabeza

RP21908
Pump
Bomba

RP21906▲
Body Assembly
Ensamble del Cuerpo

RP38673▲
Base
Base

RP21945
Nut
Tuerca

RP21904
Bottle
Botella

RP40385▲
Soap/Lotion
Dispenser Assembly
Ensamble del Surtidor
de Jabón/Loción



RP21908
Pump
Bomba

RP40678
Body Assembly
Ensamble del Cuerpo

RP40387▲
Base & Gasket
Base con Empaque



RP21945
Nut
Tuerca

RP21904
Bottle
Botella

RP30395
Vented Funnel
Embudo con Ventiladero

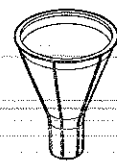

RP5881
Spout Assy.-4"-1H Kitchen
Ensamble del Tubo de Salida-4"-1H Cocina

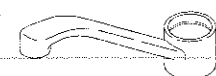

RP9633
Spout Assy.-6"-1H Kitchen
Ensamble del Tubo de Salida-6"-1H Cocina

RP5654
Spout Assy.-8"-1H Kitchen
Ensamble del Tubo de Salida-8"-1H Cocina

RP5653
Spout Assy.-10"-1H Kitchen
Ensamble del Tubo de Salida-10"-1H Cocina

RP6042
Spout Assy.-12"-1H Kitchen
Ensamble del Tubo de Salida-12"-1H Cocina

RP3614
Repair Kit
Herramientas para
Reparaciones



RP1974
Wrench-Handle/Adjusting Ring
Llave-Manija/Anillo de Ajuste

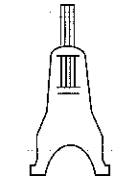

RP22132
Helpful Hand Installation Aid
Utensilio para Asistencia en Instalaciones a Mano



RP23489
Plumbers Hook - Seat, Spring & Spout O-Ring Removal Tool
Gancho de Plomero-Asiento, Resorte y Herr. para Sacar Anillo "O" del Tubo de Salida

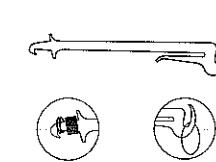

RP20587
Bonnet Removal Wrench-(RP50 w/Knurls)
Llave para Sacar Capuchones-(RP50 con Estrias)

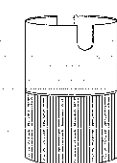

RP2932
Boxed Assortment Maintenance Parts Kit
Piezas Surtidas de Mantenimiento en Caja

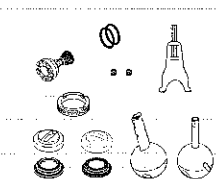

RP1740
Stem Unit Assy.- 2H-SS Plate
Ensamble Unidad-Espiga, 2H-Placa de Acero Inoxidable

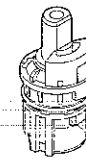

RP2189
Spray Round Swivel Aerator
Rociador-Aireador Giratorio Redondo



RP40301
Quick Connect Vegetable Spray Cap
Tapa para el Rociador de Vegetales de Conexión Rápida

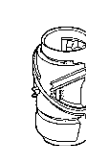

RP40307
Quick Connect Spout Hose-67"
Manguera de Conexión Rápida-67"

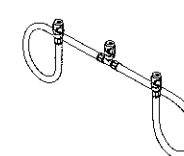

RP40308BL, GR, WH
6" Vegetable Spray Hose & Quick Connect Adapters
Manguera de 6" para el Rociador de Vegetales y Adaptadores de Conexión Rápida

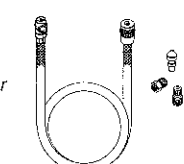

RP41478
Quick Connect Nut & Adapter
Tuerca y Adaptador de Conexión Rápida

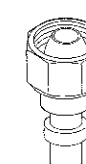

RP8230
Ceramic Stem Unit, Seat, O-Ring, Spring & Screw
Unidad del Vástago de Cerámica, Asiento, Anillo "O", Resorte y Tornillo

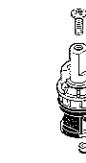

KITCHEN/BAR

Single Handle Lavatory Faucets Llave (Mezcladora) MonoControl para Lavamanos

Classic Series Models/Modelos 500, 501, 510* & 520 Series

LAVATORY

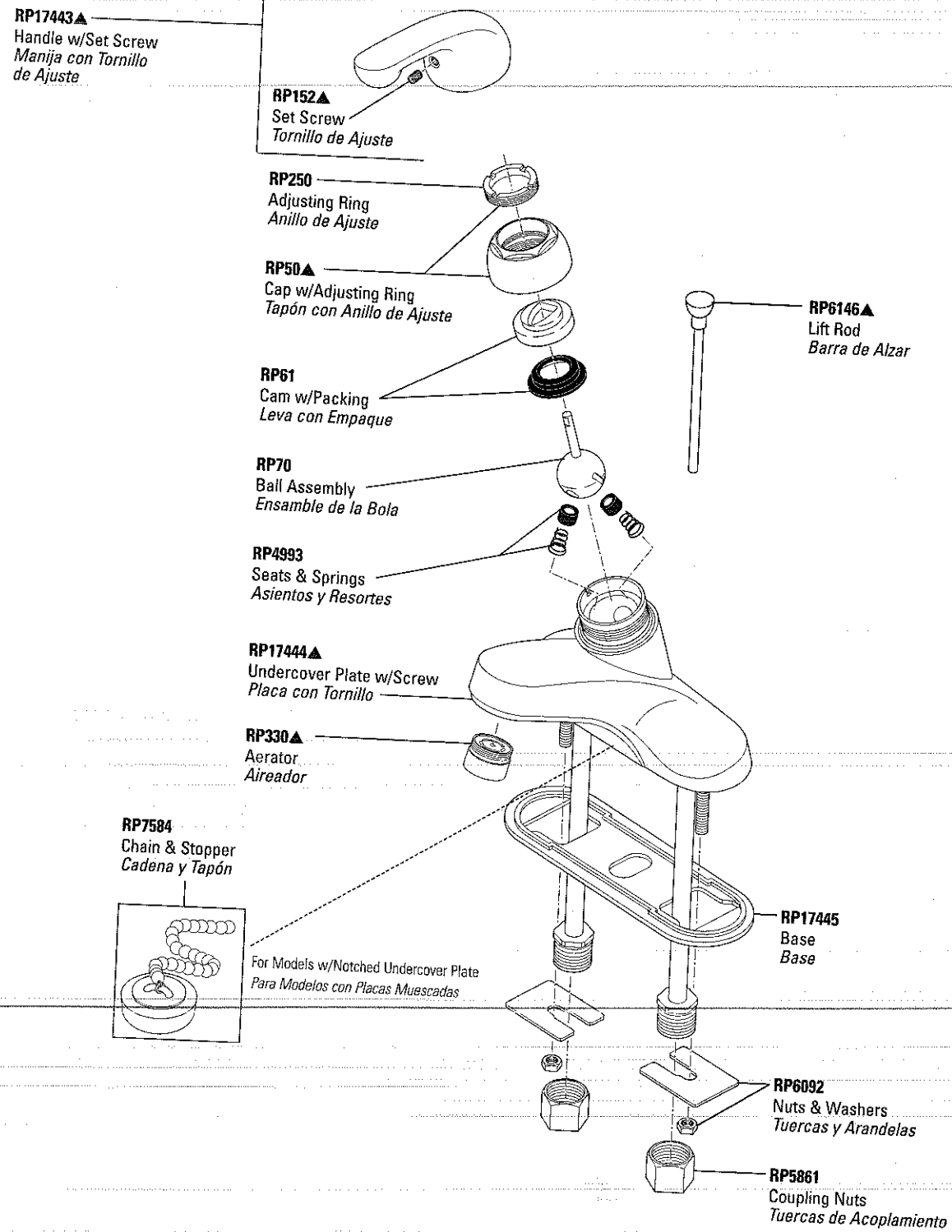

Refer to pages 100-101 for lavatory drain assemblies. / Para ensamble de drenaje para lavamanos referirse a las paginas 100-101.

▲Specify finish / Especificque el Acabado
*Discontinued model—some components may not be available. / Modelo descontinuado - algunos componentes pueden no estar disponibles.

Single Handle Lavatory Faucets Llave (Mezcladora) MonoControl para Lavamanos

Classic Series Models/Modelos 505 & 525 Series

LAVATORY

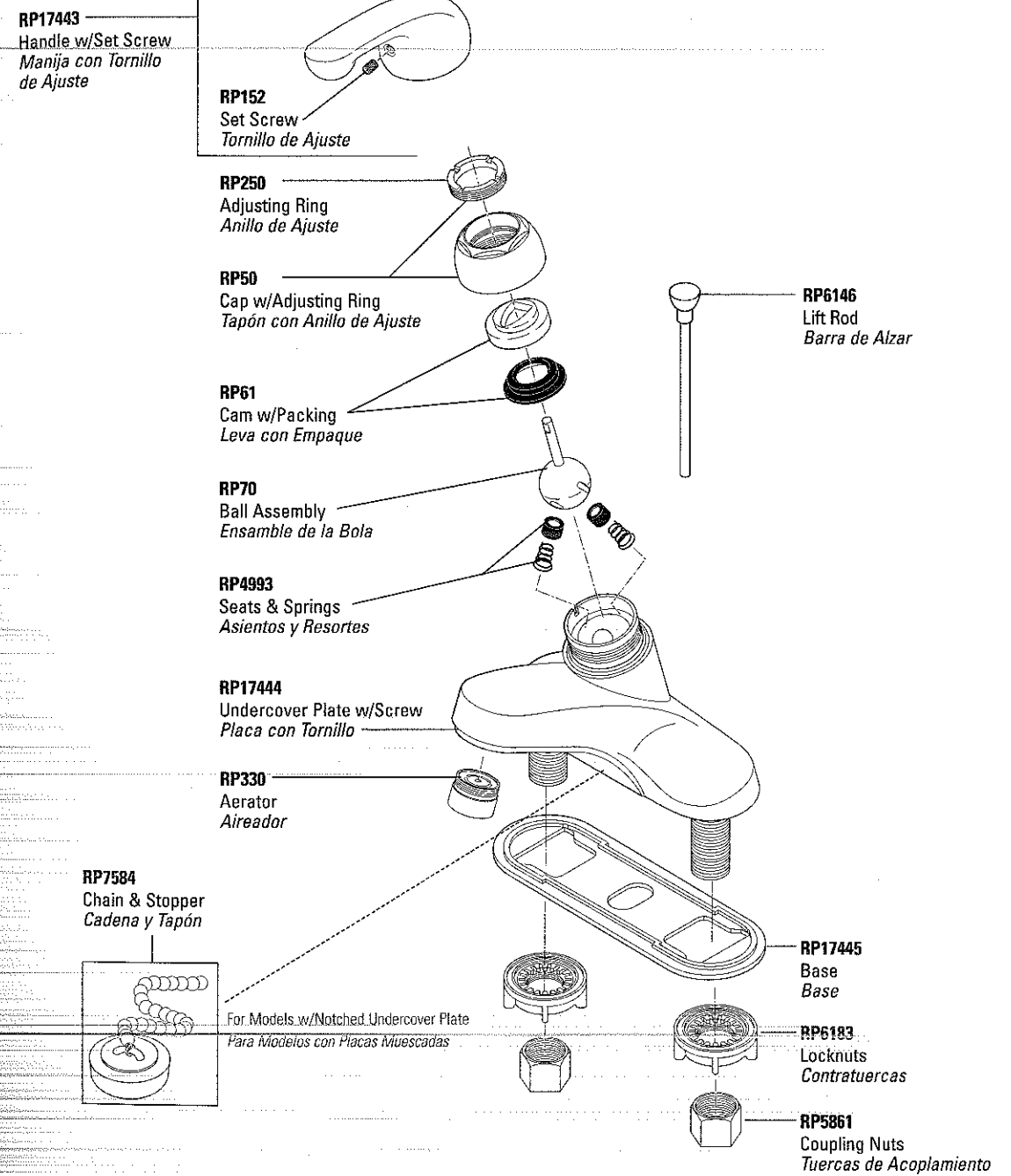

Refer to pages 100-101 for lavatory drain assemblies. / Para ensamble de drenaje para lavamanos referirse a las paginas 100-101.

Single Handle Lavatory Faucets Llave (Mezcladora) MonoControl para Lavamanos

Classic Series Models/Modelos 502, 503* & 522 Series

LAVATORY

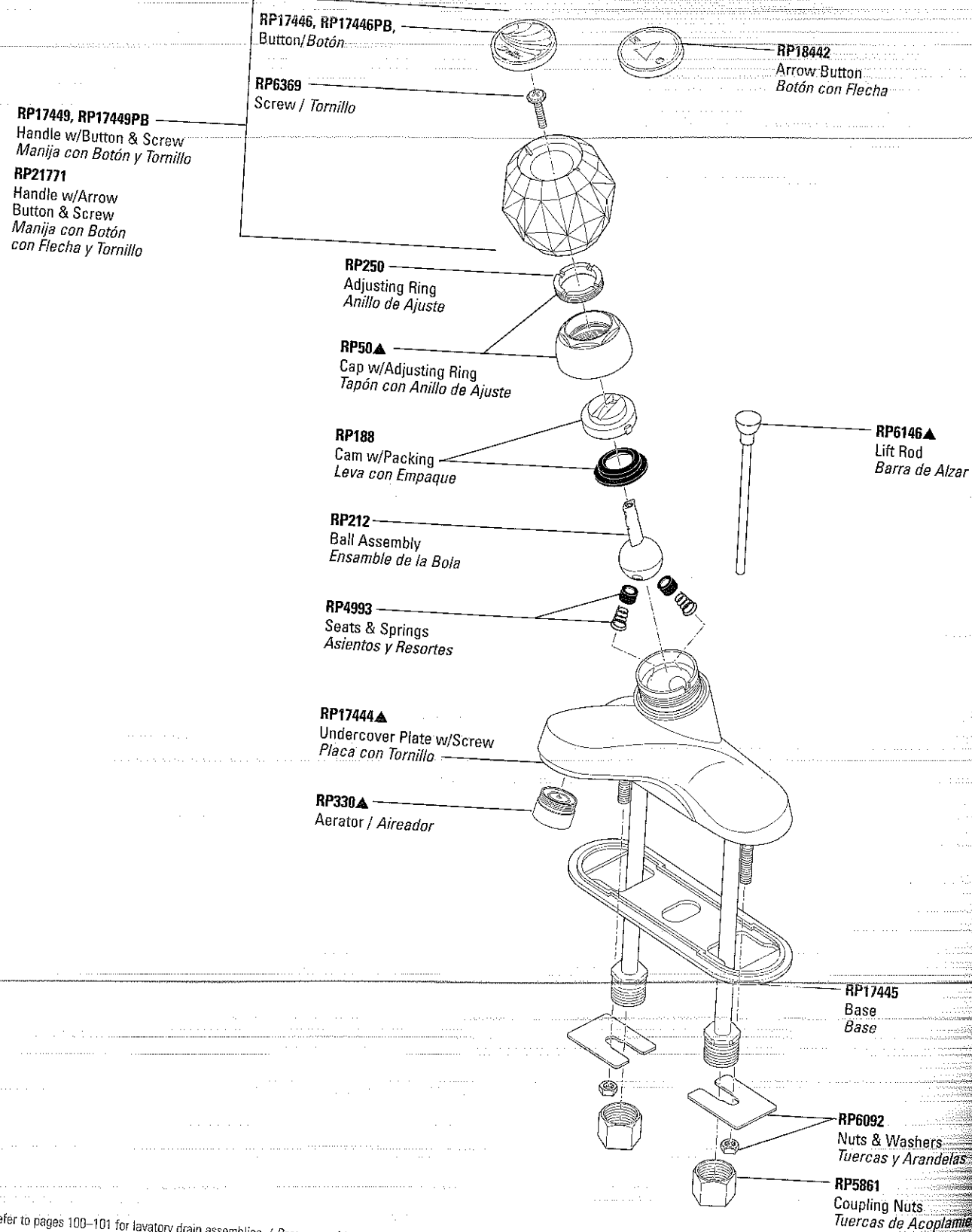

Refer to pages 100-101 for lavatory drain assemblies. / Para ensamble de drenaje para lavamanos referirse a las paginas 100-101.

▲ Specify finish / Especificar el Acabado

*Discontinued model - some components may not be available. / Modelo discontinuado - algunos componentes pueden no estar disponibles.

Single Handle Lavatory Faucets Llave (Mezcladora) MonoControl para Lavamanos

Classic Series Models/Modelos 504* & 524 Series

LAVATORY

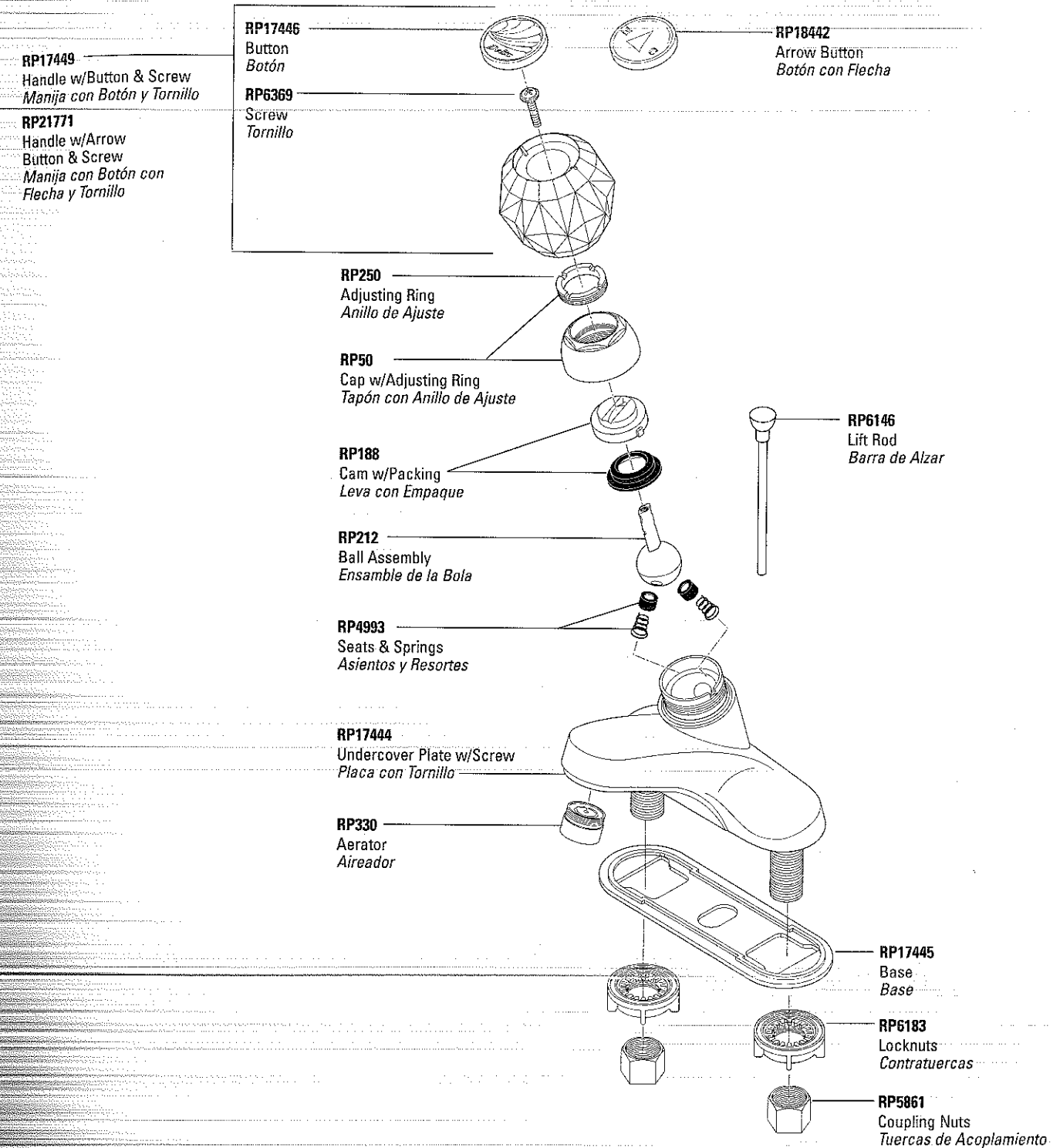

Refer to pages 100-101 for lavatory drain assemblies. / Para ensamble de drenaje para lavamanos referirse a las paginas 100-101.

*Discontinued model - some components may not be available. / Modelo discontinuado - algunos componentes pueden no estar disponibles.

Single Handle Lavatory Faucets

Llave (Mezcladora) MonoControl para Lavamanos

Innovations® Series Models/Modelos 540 & 541 Series

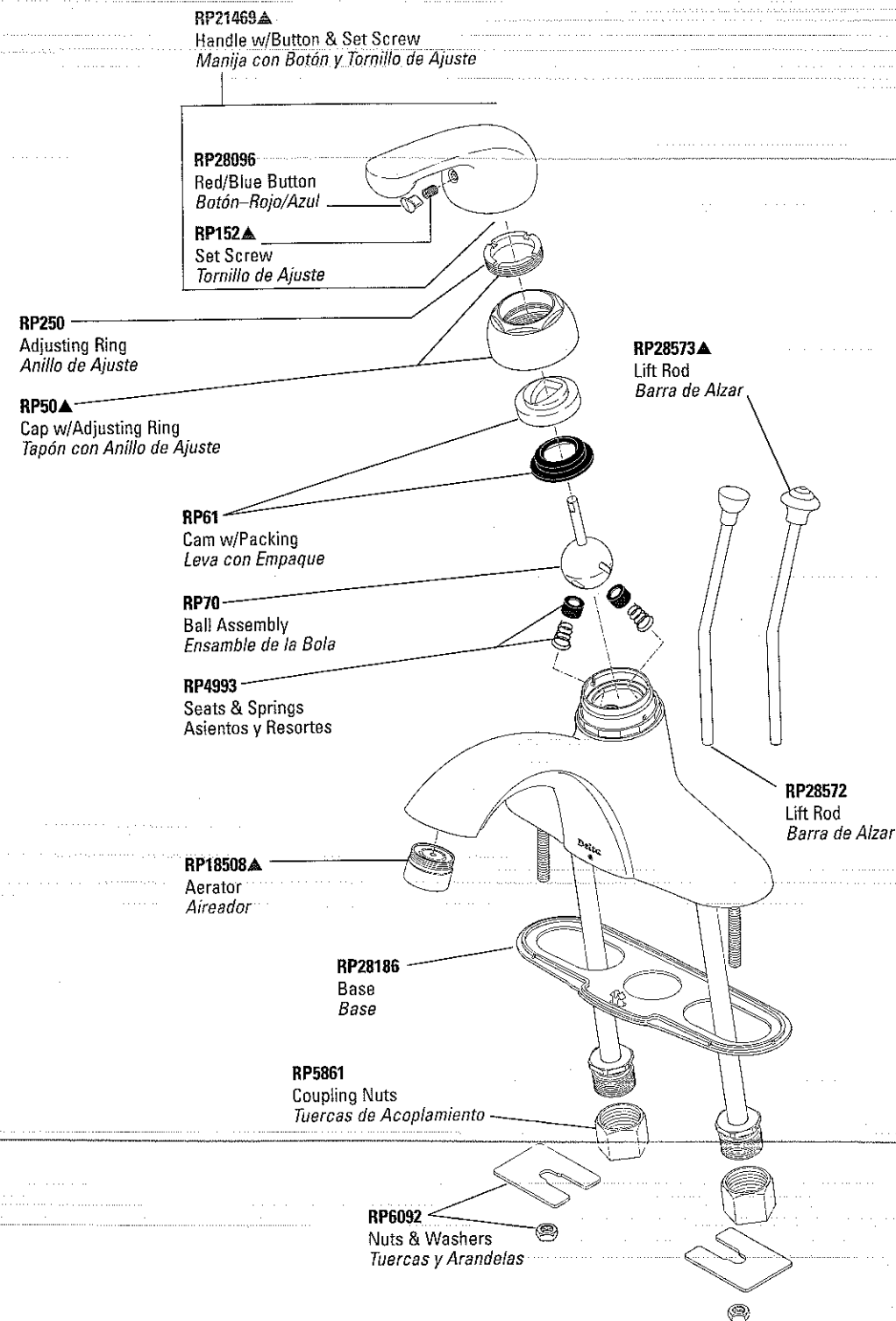

Single Handle Lavatory Faucets

Llave (Mezcladora) MonoControl para Lavamanos

Innovations® Series Model/Modelo 542 Series

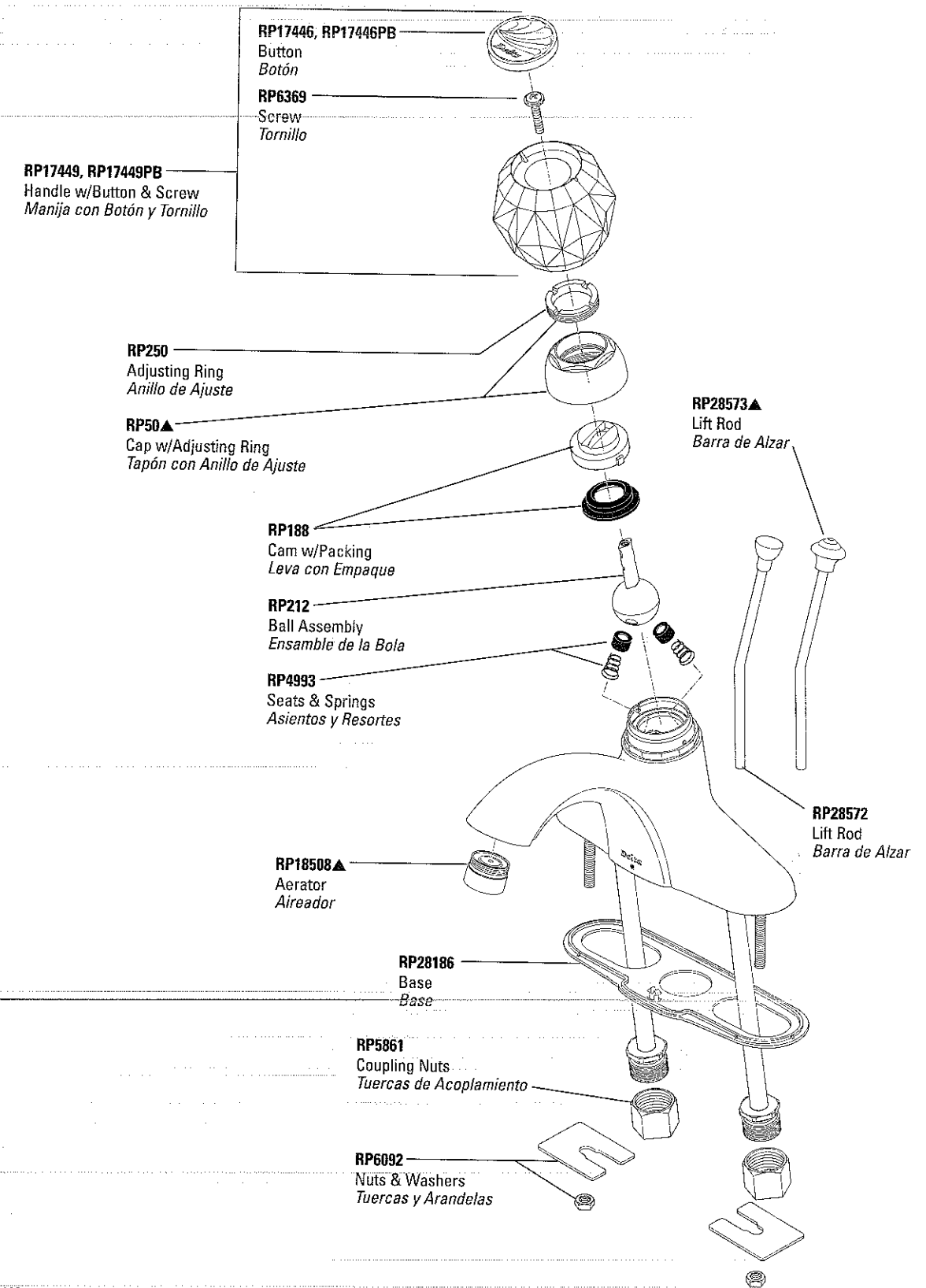

Refer to pages 100-101 for lavatory drain assemblies. / Para ensamble de drenaje para lavamanos referirse a las paginas 100-101.

Refer to pages 100-101 for lavatory drain assemblies. / Para ensamble de drenaje para lavamanos referirse a las paginas 100-101.

Single Handle Lavatory Faucets Llave (Mezcladora) MonoControl para Lavamanos

Innovations® Series Model/Modelo 544 Series

Single Handle Lavatory Faucets Llave (Mezcladora) MonoControl para Lavamanos

Handi-Lav® Utility Series Model/Modelo 550 Series

LAVATORY

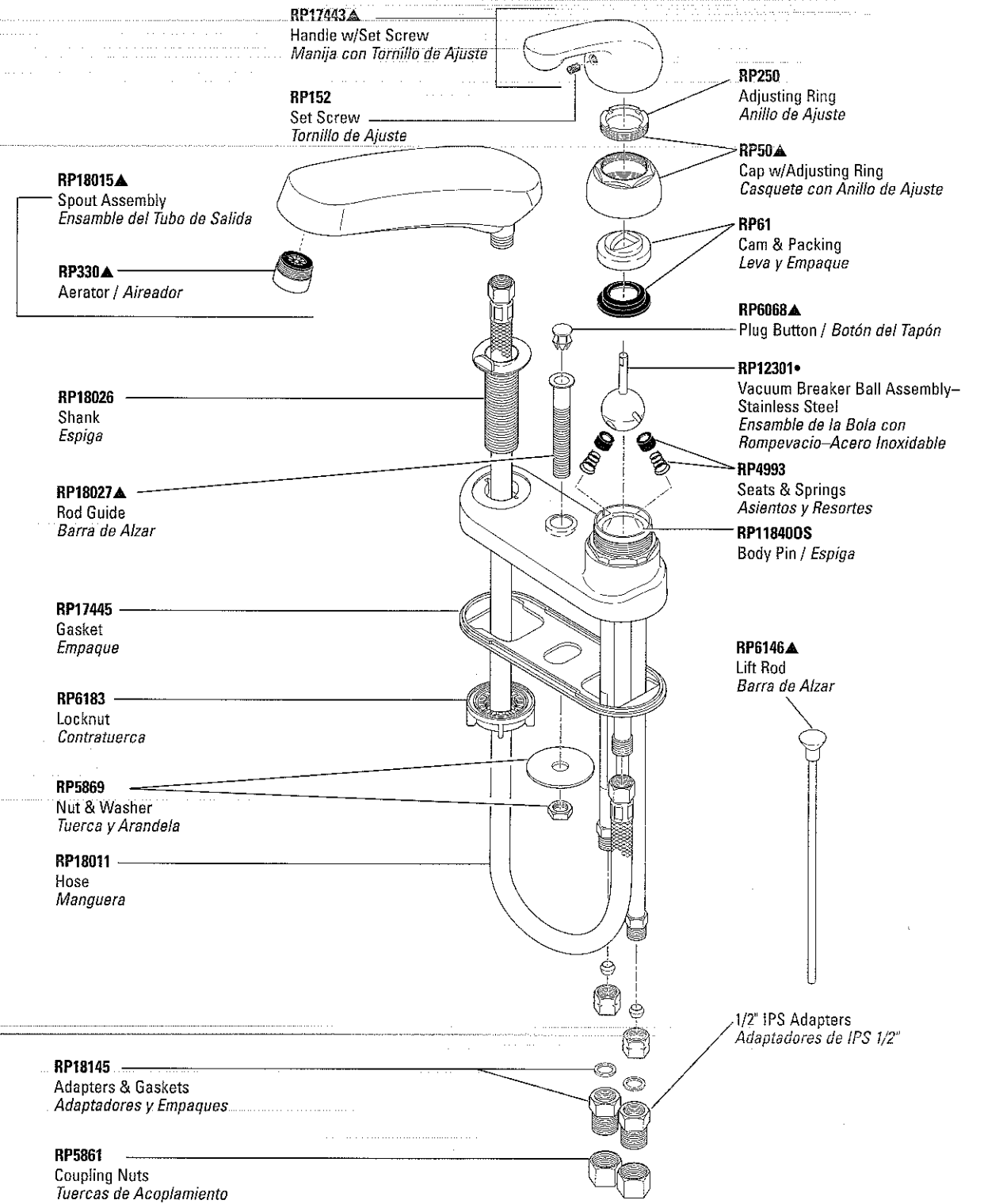
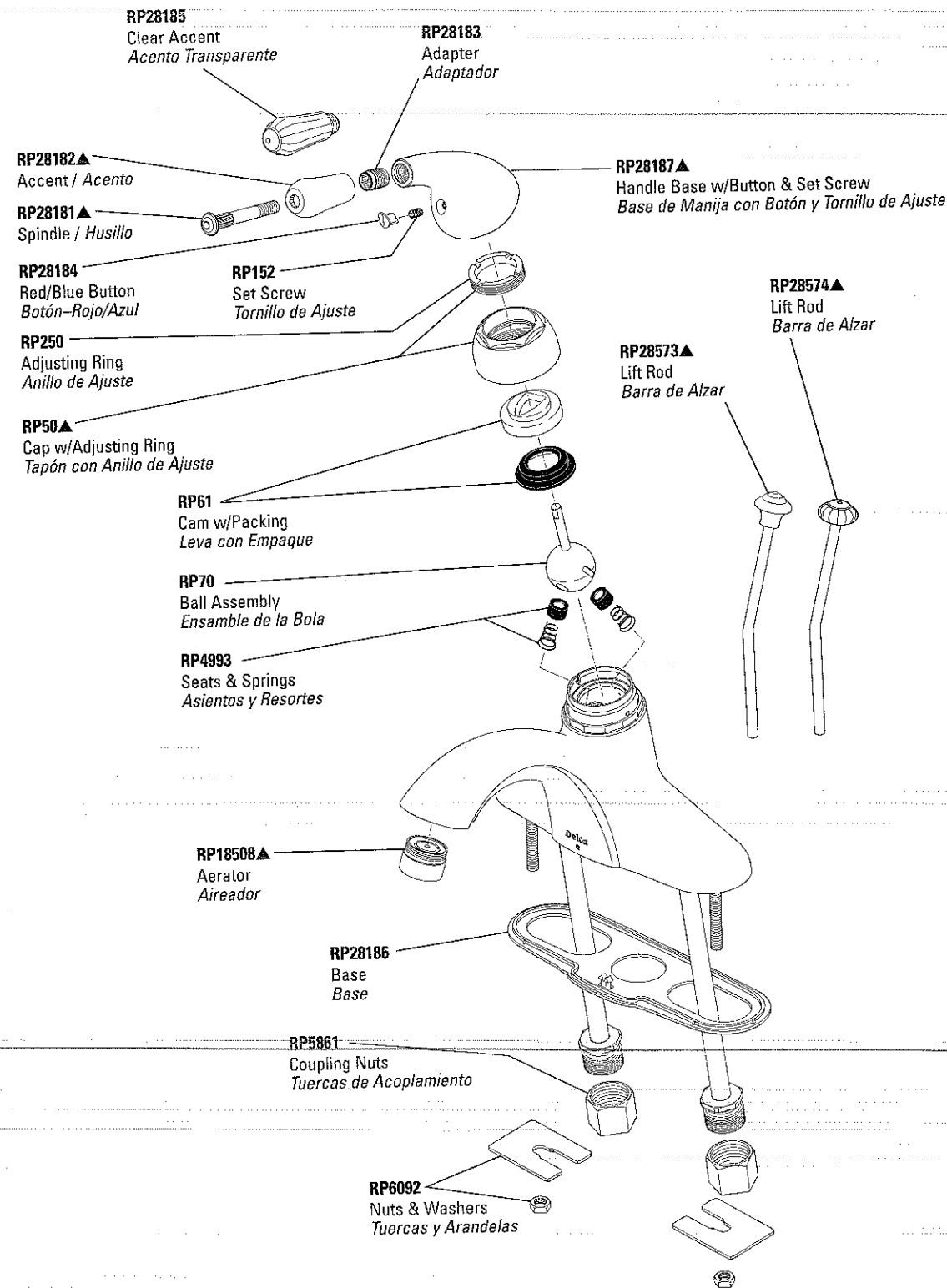

LAVATORY

Refer to pages 100–101 for lavatory drain assemblies. / Para ensamble de drenaje para lavamanos refiérase a las páginas 100–101.

Refer to pages 100–101 for lavatory drain assemblies. / Para ensamble de drenaje para lavamanos refiérase a las páginas 100–101.

•The vacuum breaker ball assembly is an important part of protecting your drinking water from contamination by back siphonage. Use only the Delta RP12301 ball assembly.
 •El ensamble de bola con rompevacío es una parte importante en proteger su agua potable de contaminación por causa del retrosedimiento de agua. Use sólo el ensamble de bola Delta RP12301.

▲Specify finish / Especificque el Acabado

Single Handle Lavatory Faucets

Llave (Mezcladora) MonoControl para Lavamanos

Handi-Lav® Utility Series Model/Modelo 552* Series

Single Handle Lavatory Faucets

Llave (Mezcladora) MonoControl para Lavamanos

Classic Series Model/Modelo 570 Series

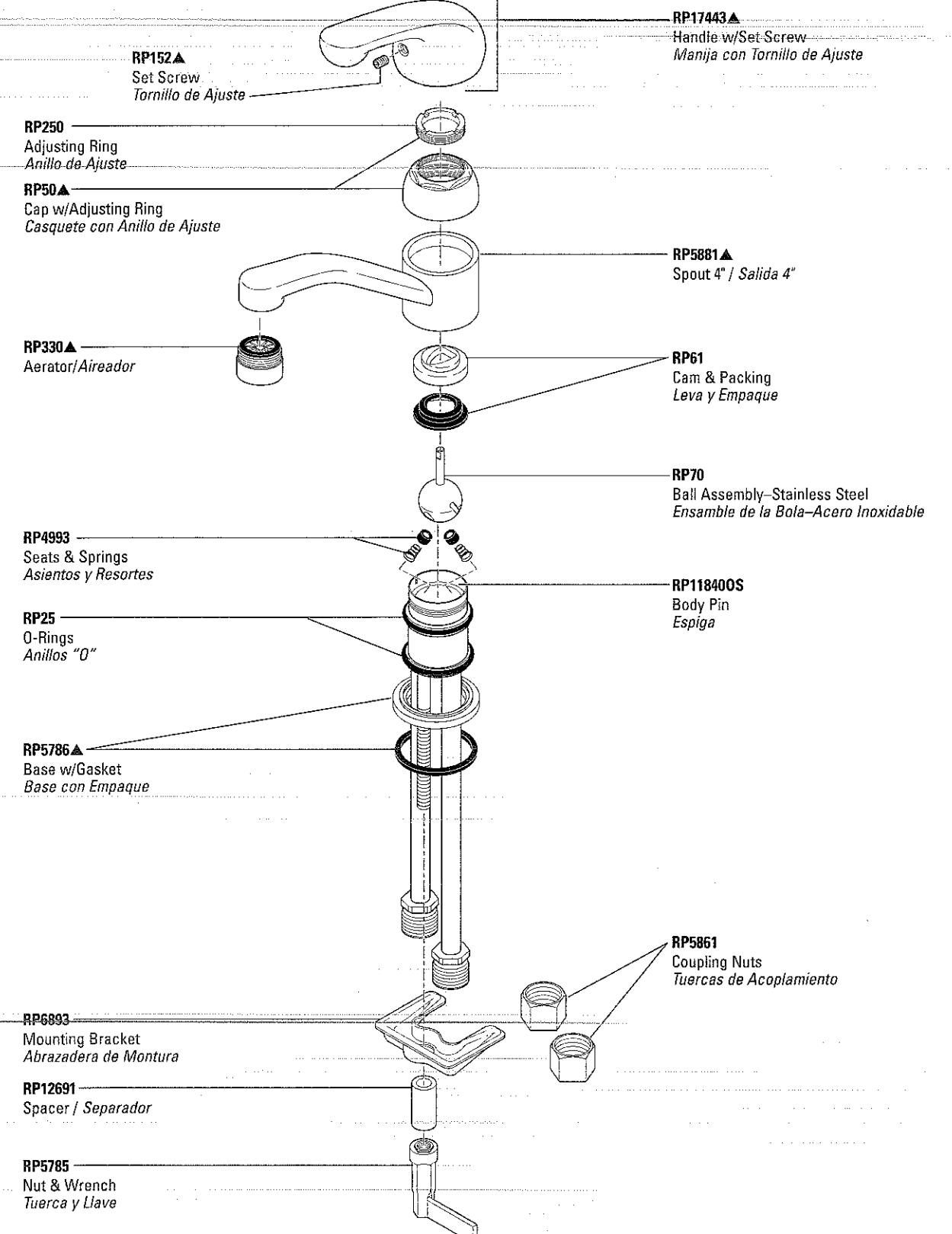
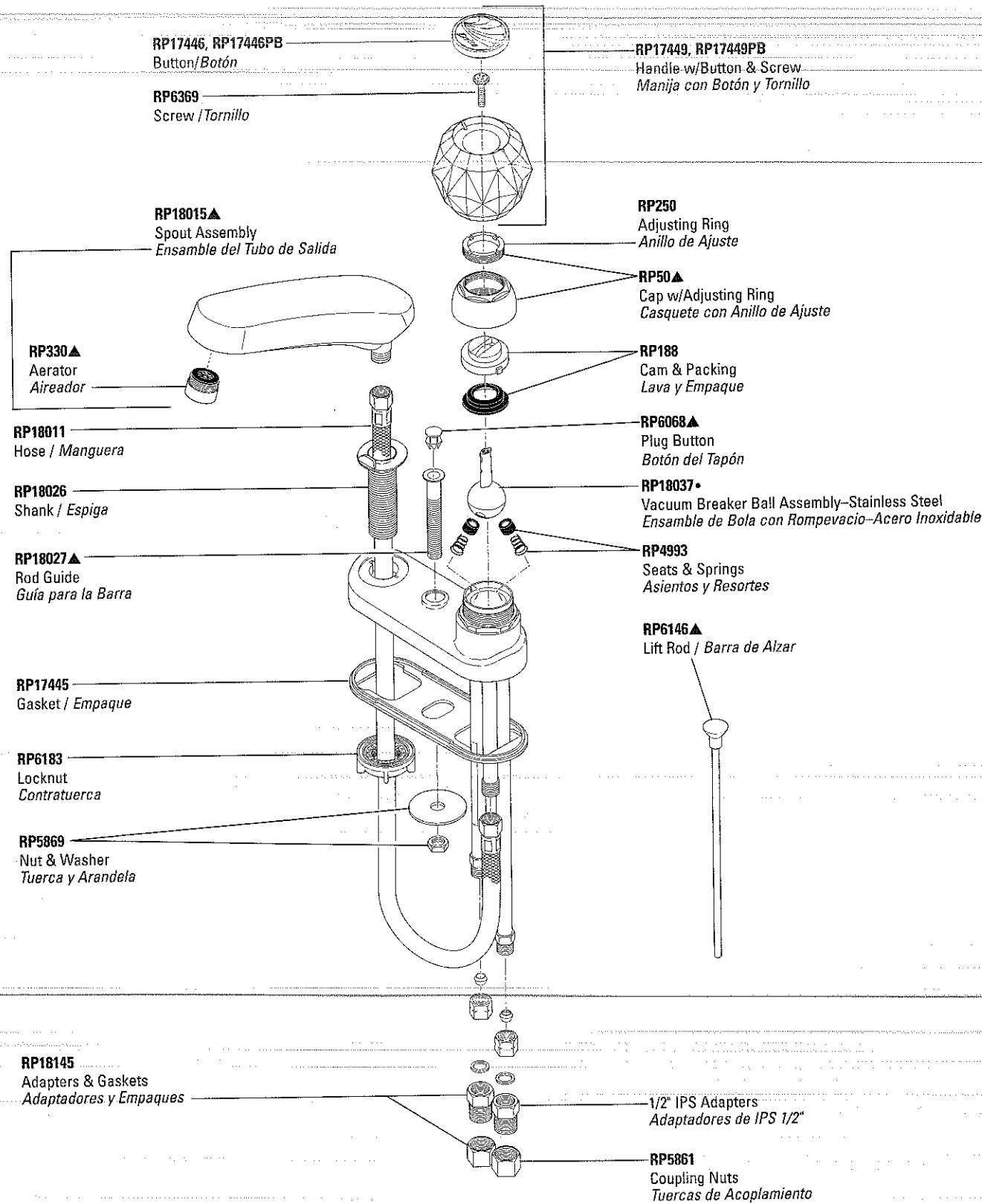

Refer to pages 100–101 for lavatory drain assemblies. / Para ensamble de drenaje para lavamanos referirse a las páginas 100–101.

- The vacuum breaker ball assembly is an important part of protecting your drinking water from contamination by back siphonage. Use only the Delta RP18037 ball assembly.
- El ensamble de bola con rompevacío es una parte importante en proteger su agua potable de contaminación por causa del retrocedimiento de agua. Use sólo el ensamble de bola Delta RP18037.

Refer to pages 100–101 for lavatory drain assemblies. / Para ensamble de drenaje para lavamanos referirse a las páginas 100–101.

▲Specify finish / Especificar el Acabado

Single Handle Lavatory Faucets

Llave (Mezcladora) MonoControl para Lavamanos

e-Flow™ Innovations® Model/Modelo 547 Series

Notes / Notas

LAVATORY

LAVATORY

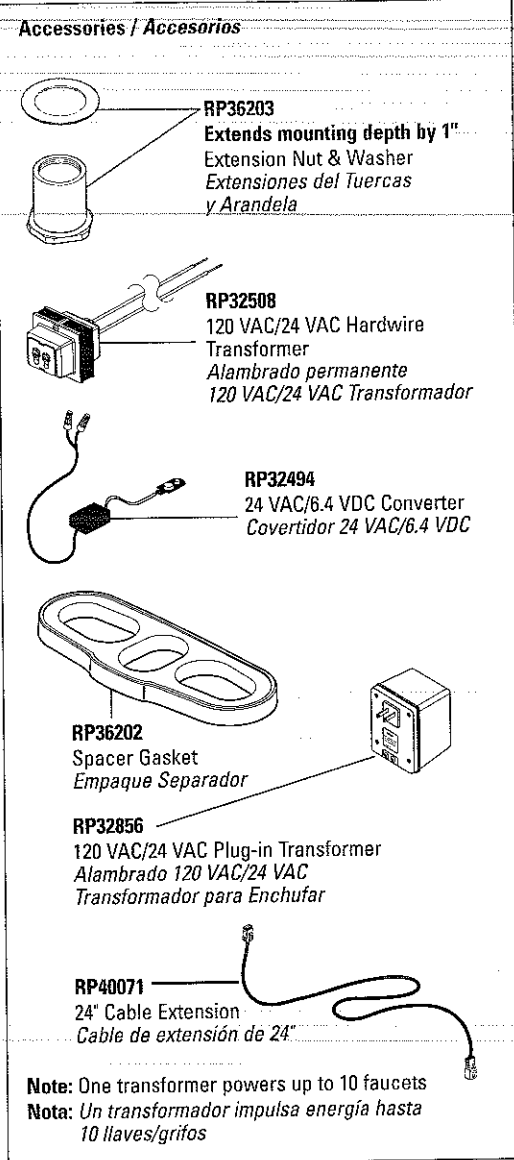
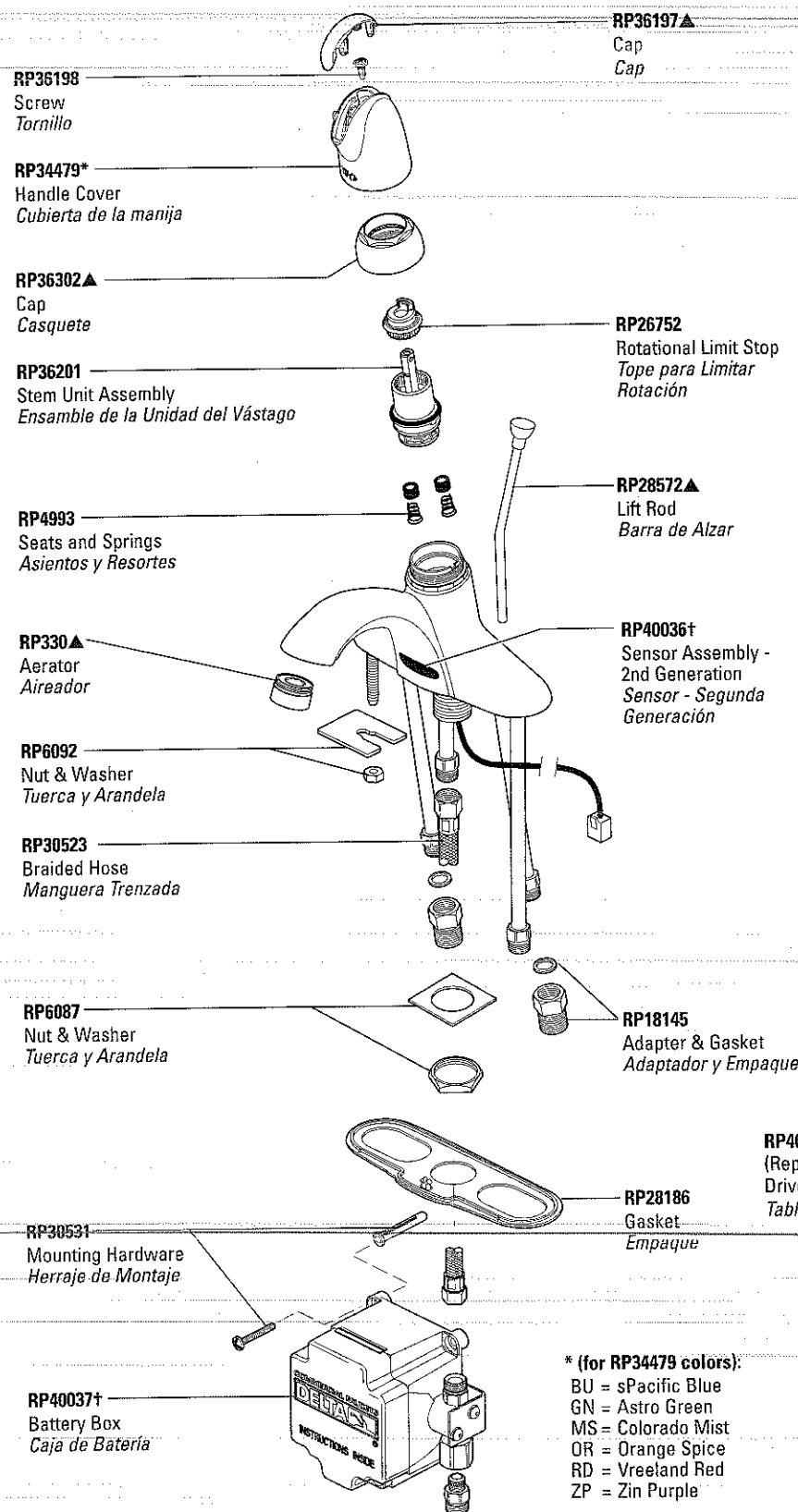

Refer to pages 100-101 for lavatory drain assemblies. / Para ensamble de drenaje para lavamanos referirse a las paginas 100-101.
 † If replacing sensor, battery box or RP34454 Wire Harness on models manufactured prior to February 2004, replace with both RP40036 and RP40037.
 Si está reemplazando el sensor, la caja de baterías, o el enganche de alambre pieza de repuesto RP34454 de los modelos fabricados antes de Febrero 2004, reemplácelo con ambos RP40036 y RP40037.

Two Handle Lavatory Faucets

Llave de Dos Manijas (Manerales) para Lavamanos

Classic Series Models/Modelos 2500, 2502, 2520, 2521 & 2522 Series

LAVATORY

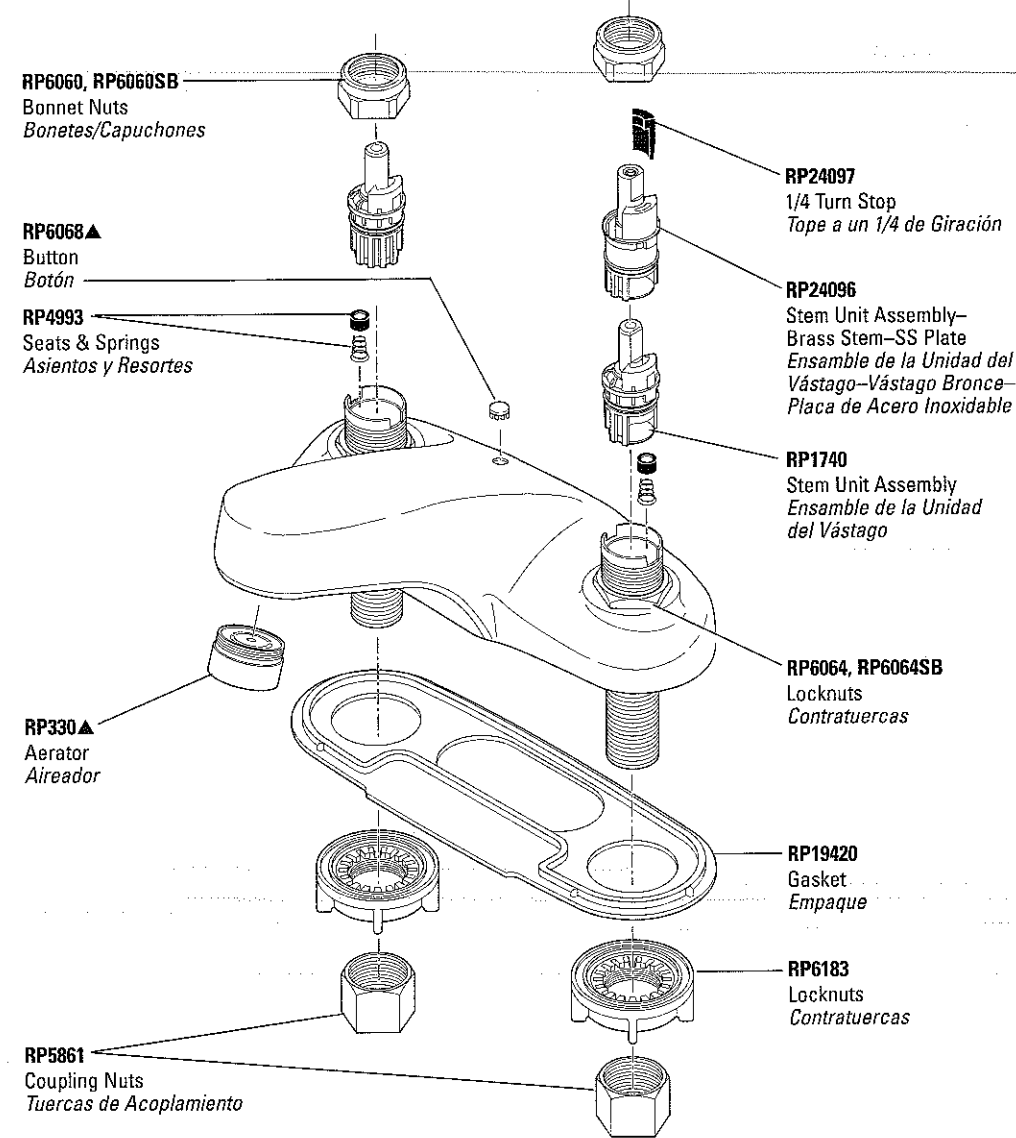

Two Handle Lavatory Faucets

Llave de Dos Manijas (Manerales) para Lavamanos

Innovations® Series Model/Modelo 2530 Series

LAVATORY

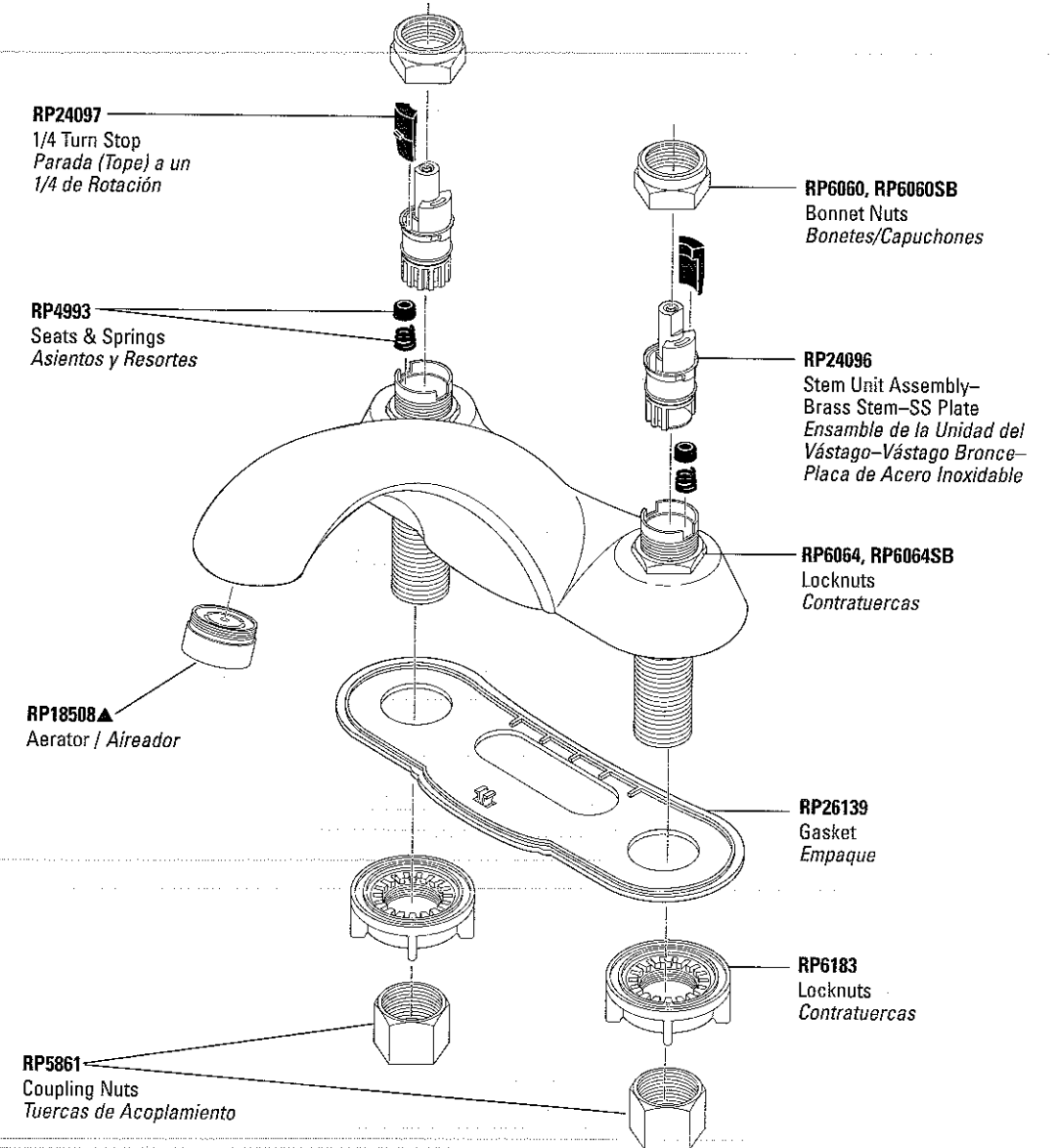

Refer to page 96 for Handles. / Para manijas refierase a la pagina 96.
 Refer to pages 98-101 for lift rods and lavatory drain assemblies. / Para ensamble de drenaje para lavamanos y barras de alzar refierase a las paginas 98-101.

Refer to page 96 for Handles. / Para manijas refierase a la pagina 96.
 Refer to pages 98-101 for lift rods and lavatory drain assemblies. / Para ensamble de drenaje para lavamanos y barras de alzar refierase a las paginas 98-101.

Two Handle Lavatory Faucets

Llave de Dos Manijas (Manerales) para Lavamanos

Victorian™ Collection Model/Modelo 2555 Series

Two Handle Lavatory Faucets

Llave de Dos Manijas (Manerales) para Lavamanos

Botanical™ Bath Collection
Freesia™ Series Model/Modelo 2560* Series

LAVATORY

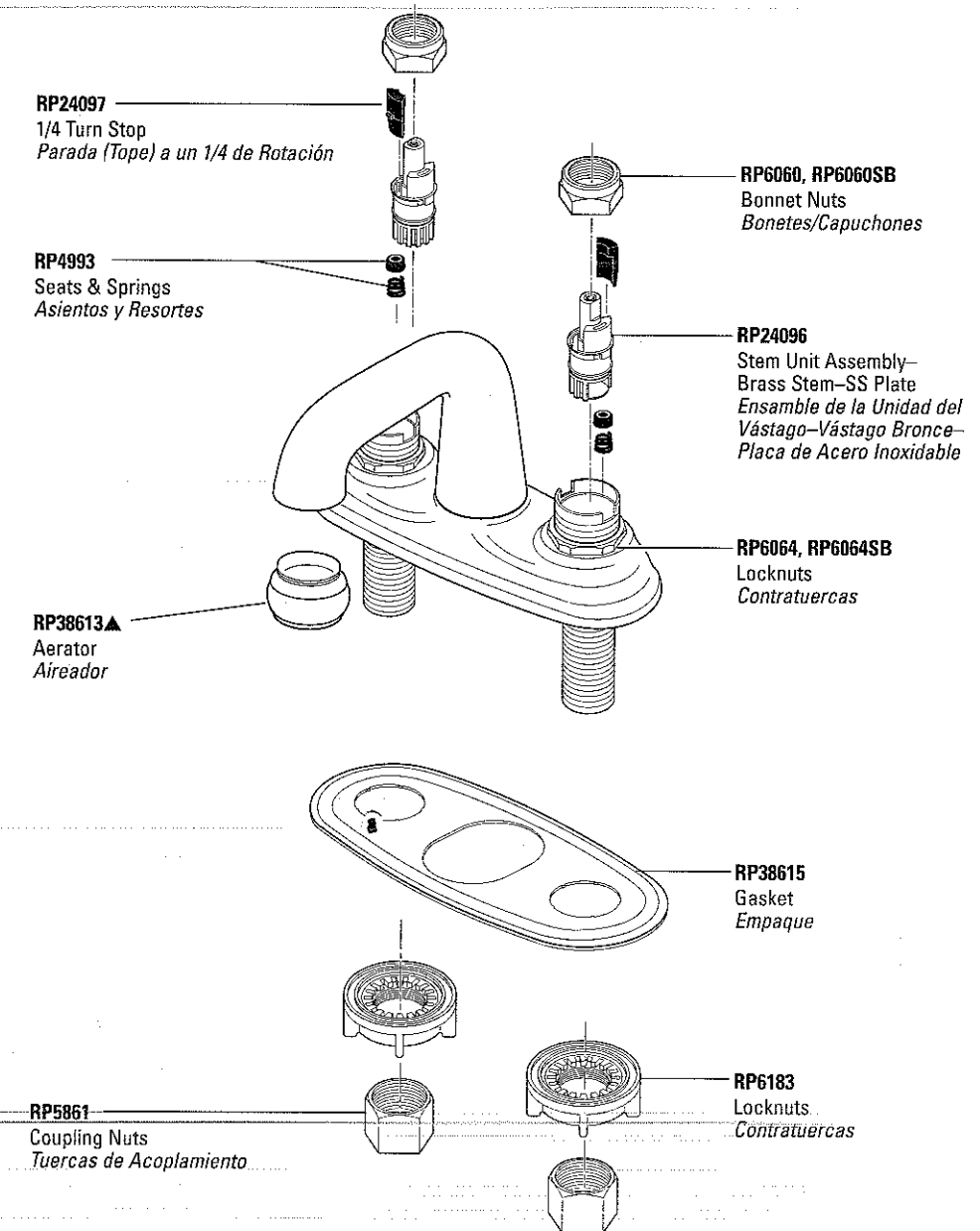
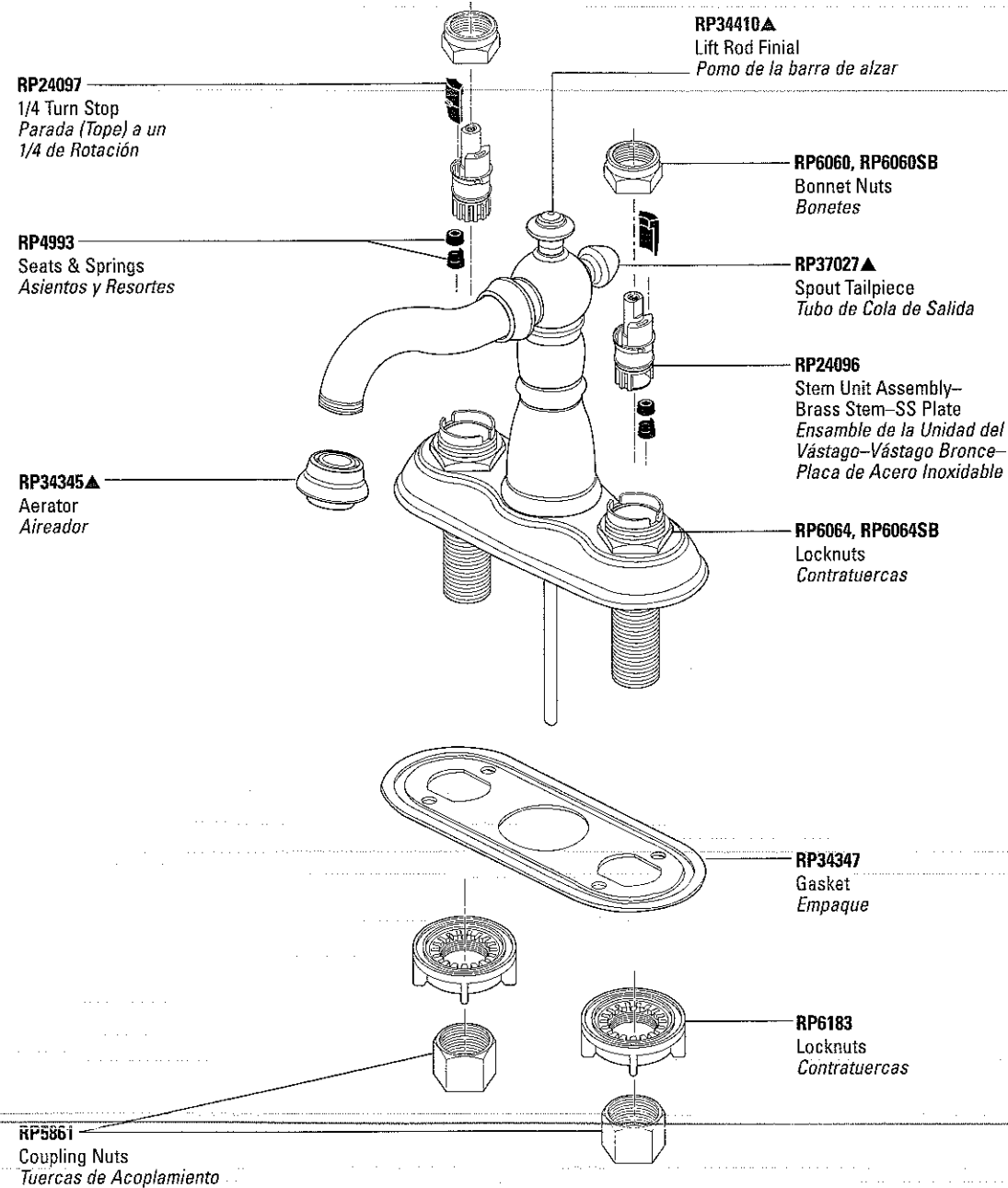

LAVATORY

Refer to page 96 for Handles. / Para manijas referirse a la pagina 96.
Refer to pages 100–101 for lavatory drain assemblies. / Para ensamble de drenaje para lavamanos referirse a las paginas 100–101.

Refer to page 96 for Handles. / Para manijas referirse a la pagina 96.
Refer to pages 98–101 for lift rods and lavatory drain assemblies. / Para ensamble de drenaje para lavamanos y barras de alzar referirse a las paginas 98–101.

Two Handle Lavatory Faucets

Llave de Dos Manijas (Manerales) para Lavamanos

Botanical™ Bath Collection
 Statice™ Series Model/Modelo 2565 Series

Two Handle Lavatory Faucets

Llave de Dos Manijas (Manerales) para Lavamanos

NEO STYLE® Series Model/Modelo 2567 Series

LAVATORY

LAVATORY

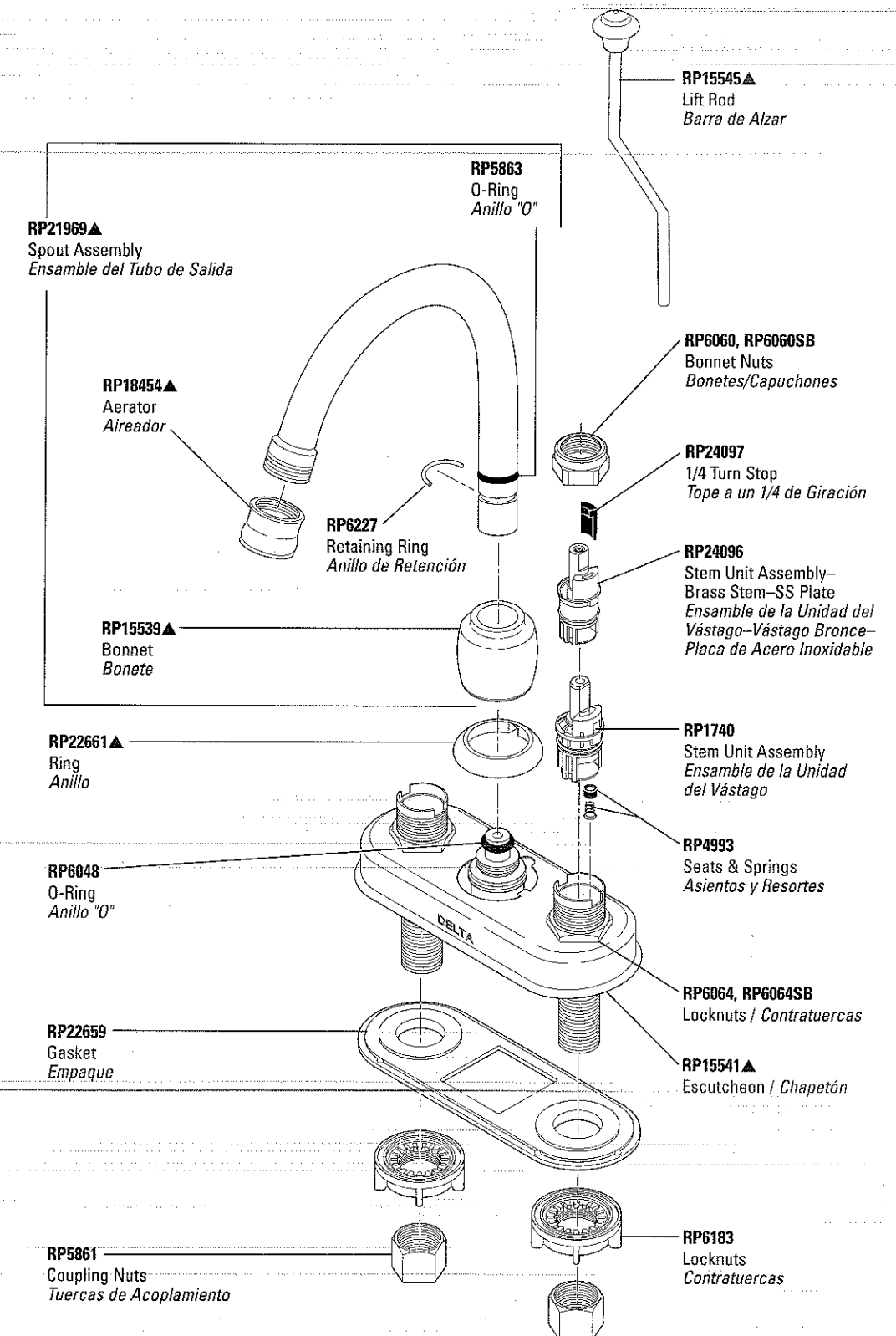
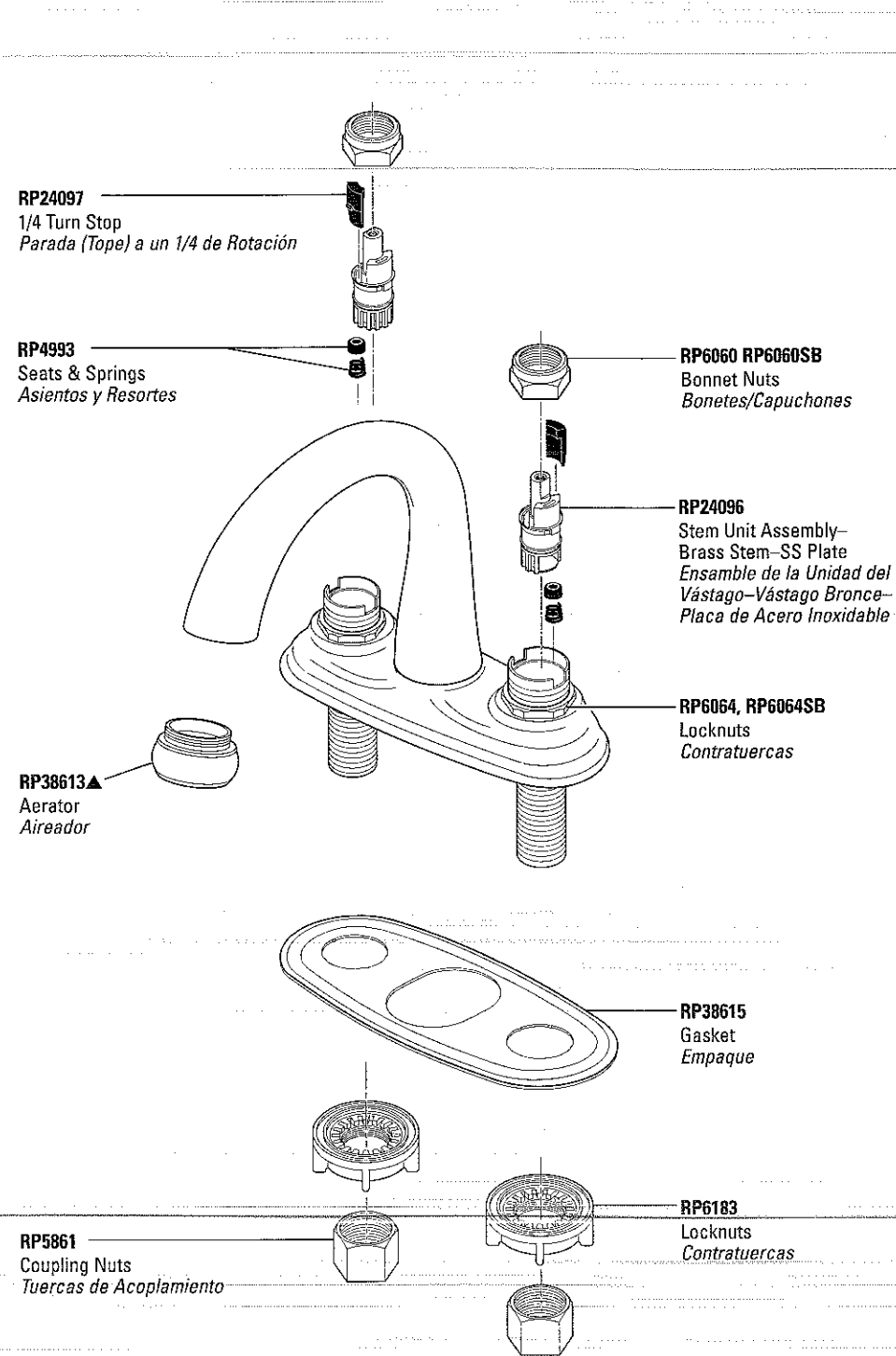

Refer to page 96 for Handles. / Para manijas referirse a la pagina 96.
 Refer to pages 98-101 for lift rods and lavatory drain assemblies. / Para ensamble de drenaje para lavamanos y barras de alzar referirse a las paginas 98-101.

Refer to page 96 for Handles. / Para manijas referirse a la pagina 96.
 Refer to pages 100-101 for lavatory drain assemblies. / Para ensamble de drenaje para lavamanos referirse a las paginas 100-101.

Two Handle Lavatory Faucets

Llave de Dos Manijas (Manerales) para Lavamanos

Teapot Spout Series Model/Modelo 2577 Series

Two Handle Lavatory Faucets

Llave de Dos Manijas (Manerales) para Lavamanos

C-Spout Series Model/Modelo 2583 Series

LAVATORY

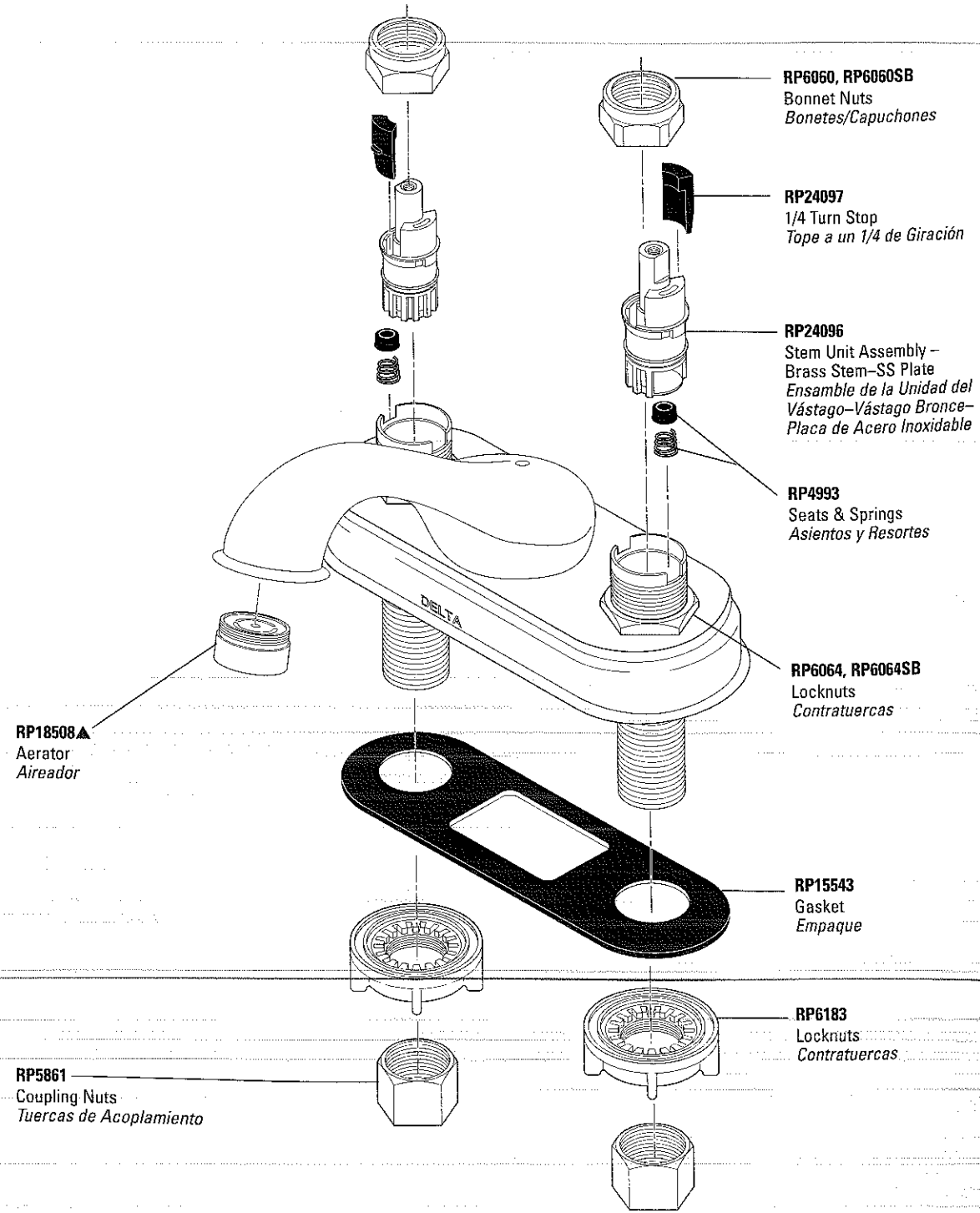

Refer to page 96 for Handles. / Para manijas referirse a la pagina 96.
 Refer to pages 98-101 for lift rods and lavatory drain assemblies. / Para ensamble de drenaje para lavamanos y barras de alzar referirse a las paginas 98-101.

LAVATORY

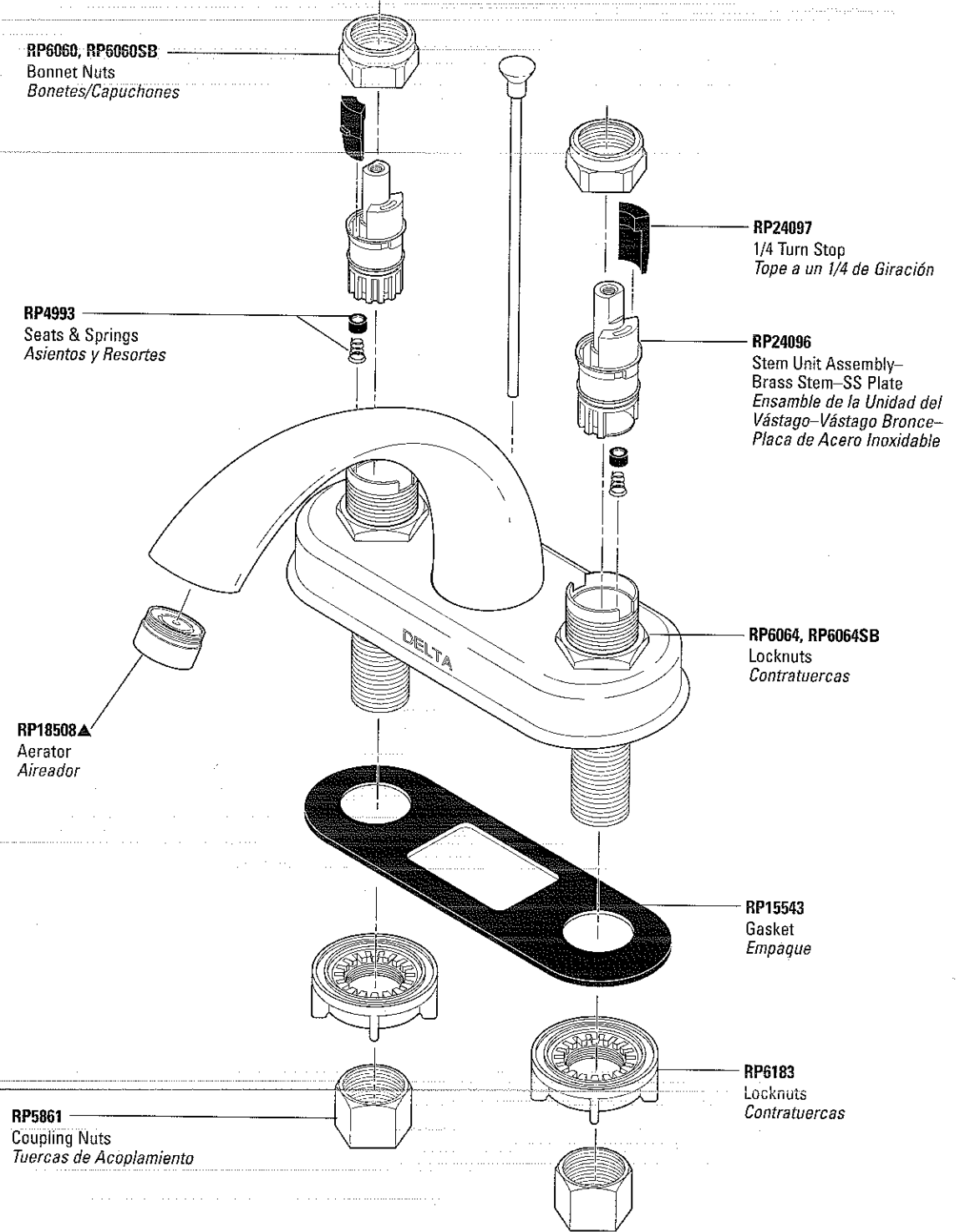

Refer to page 96 for Handles. / Para manijas referirse a la pagina 96.
 Refer to pages 98-101 for lift rods and lavatory drain assemblies. / Para ensamble de drenaje para lavamanos y barras de alzar referirse a las paginas 98-101.

Two Handle Lavatory Faucets

Llave de Dos Manijas (Manerales) para Lavamanos

Botanical™ Bath Collection
Azalea™ Series Model/Modelo 2580 Series

LAVATORY

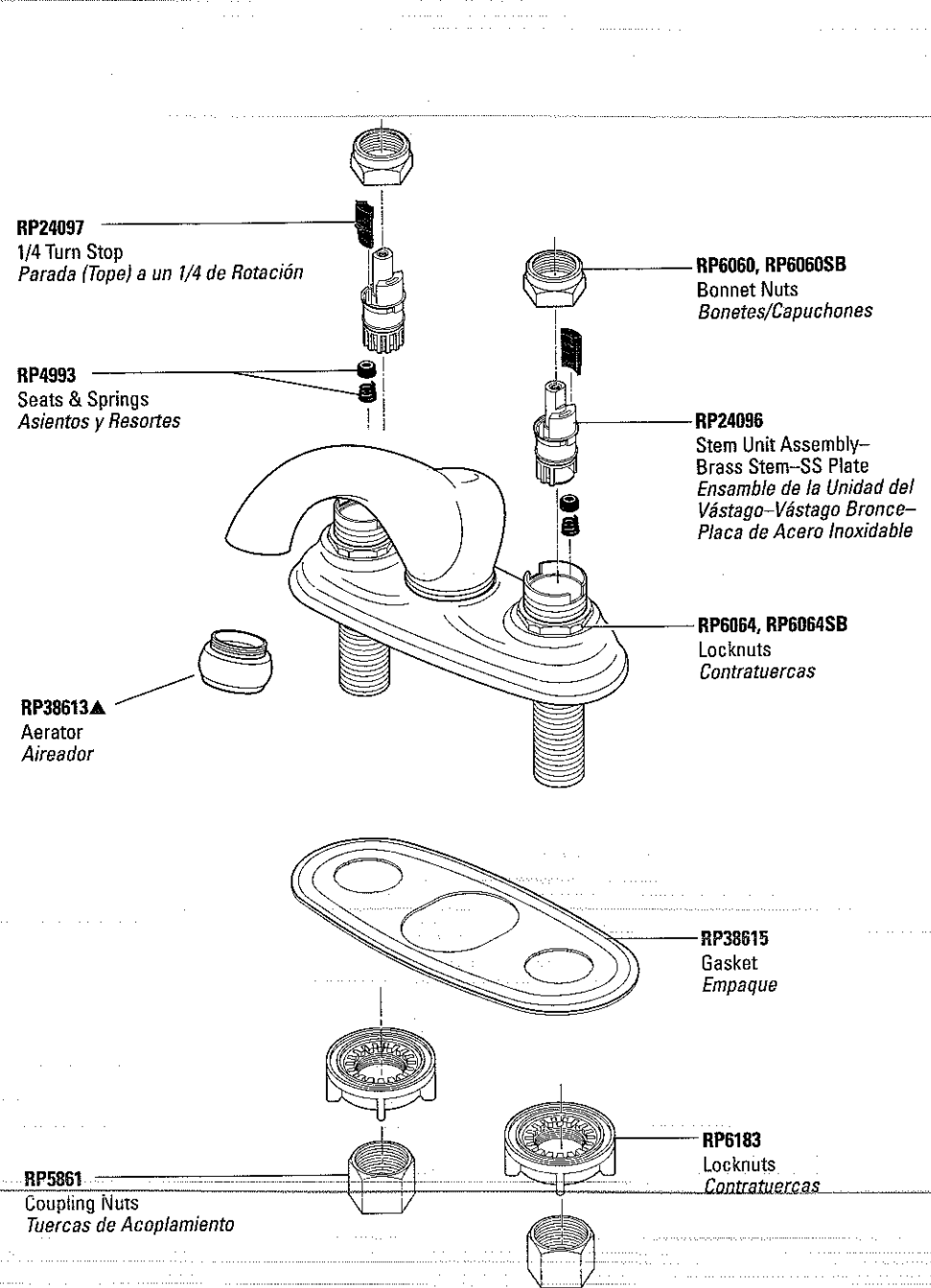

Refer to page 96 for Handles. / Para manijas referirse a la pagina 96.
Refer to pages 98-101 for lift rods and lavatory drain assemblies. / Para ensamble de drenaje para lavamanos y barras de alzar referirse a las paginas 98-101.

Two Handle Lavatory Faucets

Llave de Dos Manijas (Manerales) para Lavamanos

Botanical™ Bath Collection
Calla Lily™ Series Model/Modelo 2585 Series

LAVATORY

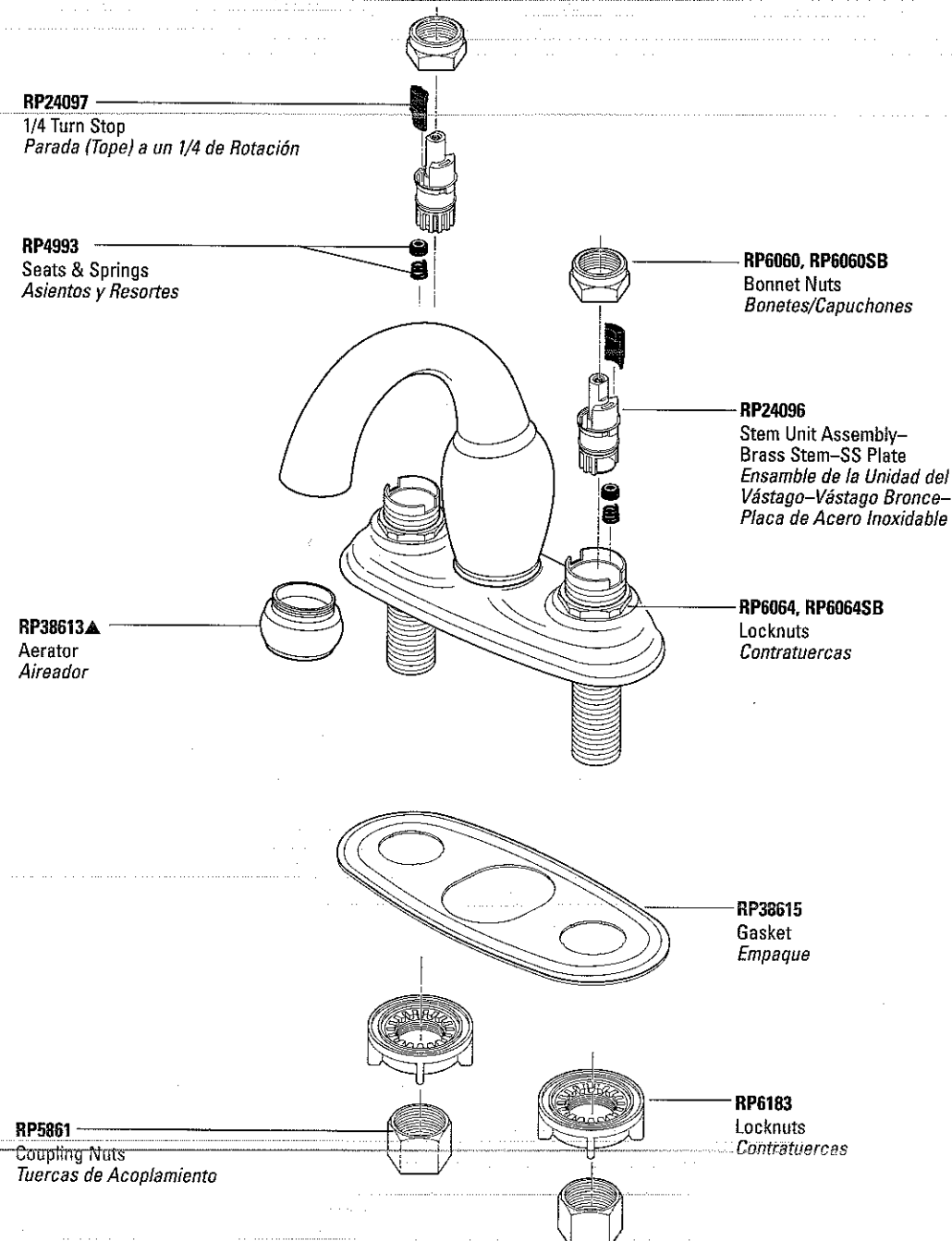

Refer to page 96 for Handles. / Para manijas referirse a la pagina 96.
Refer to pages 98-101 for lift rods and lavatory drain assemblies. / Para ensamble de drenaje para lavamanos y barras de alzar referirse a las paginas 98-101.

Two Handle Lavatory Faucets

Llave de Dos Manijas (Manerales) para Lavamanos

Two Handle Lavatory Faucets

Llave de Dos Manijas (Manerales) para Lavamanos

MICHAEL GRAVES
COLLECTION

Model/Modelo 2588 Series

Classic Series Models/Modelos 3504*, 3523*, 3524* Series

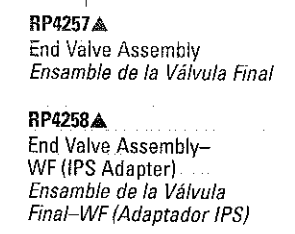
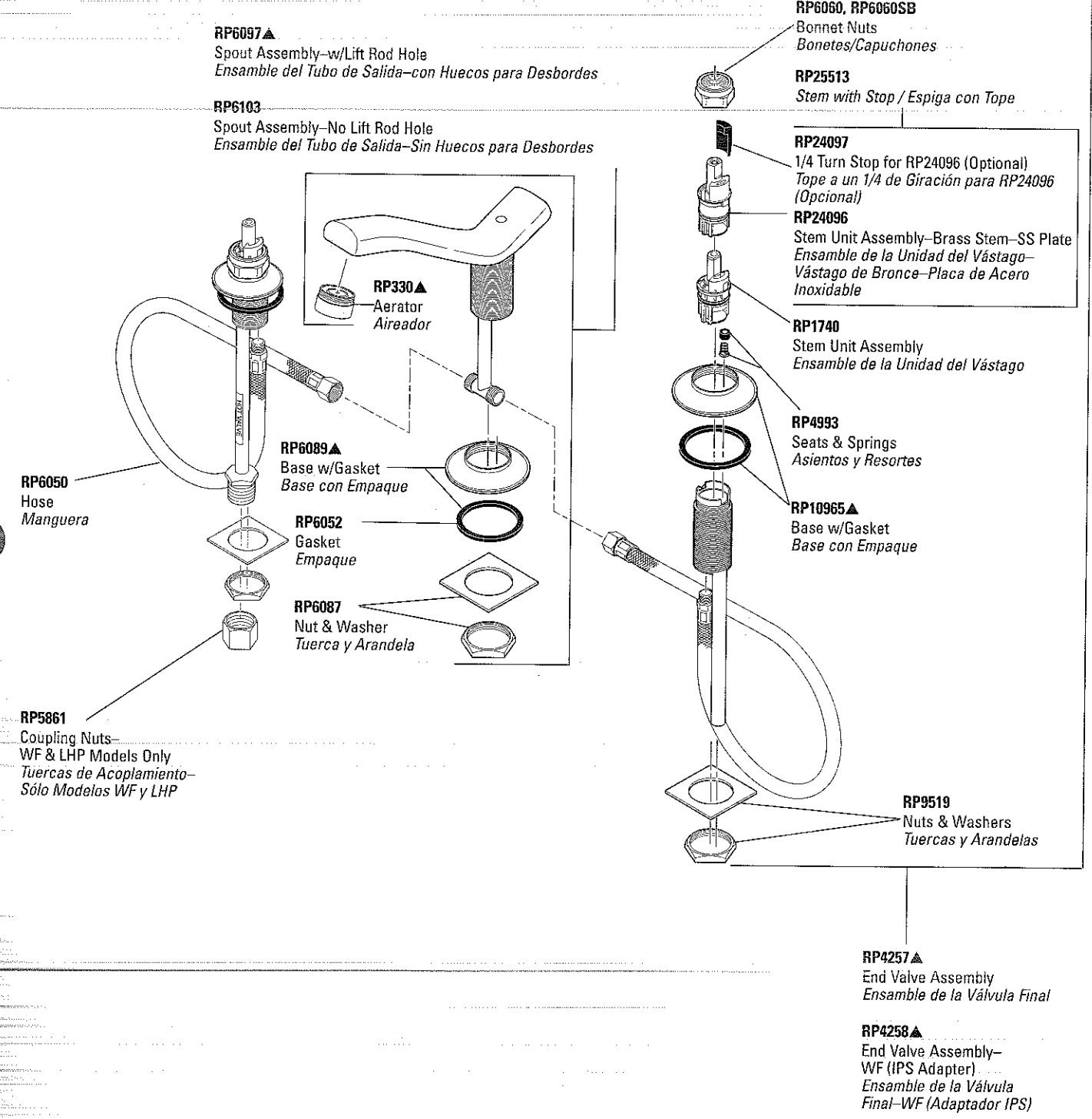
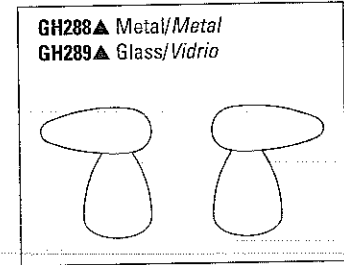
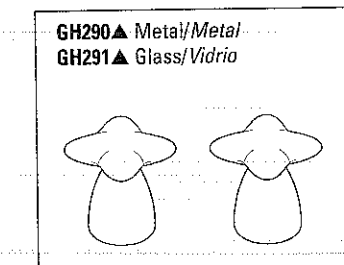
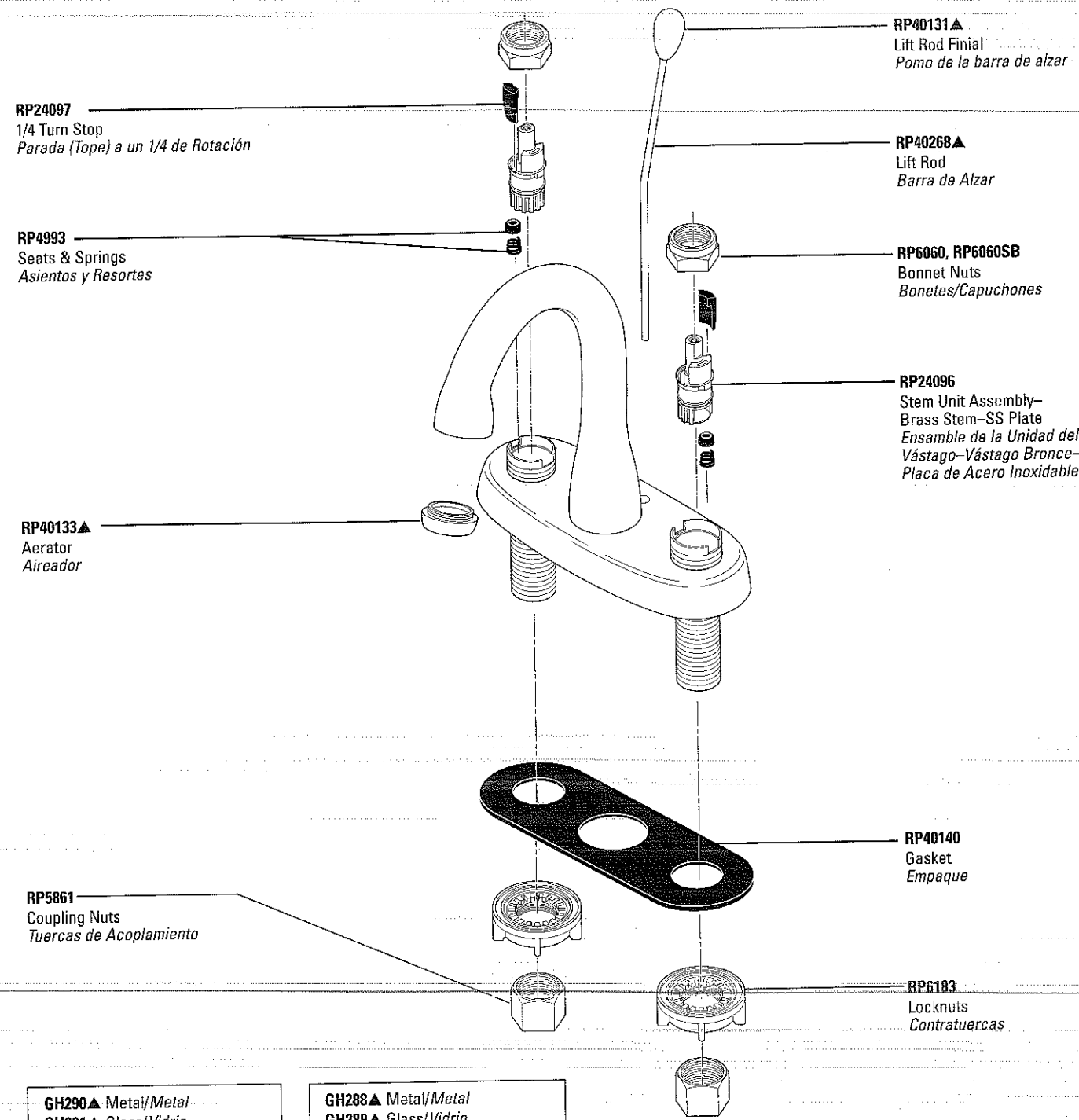

Refer to pages 100–101 for lavatory drain assemblies. / Para ensamble de drenaje para lavamanos refierase a las paginas 100–101.

Refer to page 96 for Handles. / Para manijas refierase a la pagina 96.
Refer to pages 98–101 for lift rods and lavatory drain assemblies. / Para ensamble de drenaje para lavamanos y barras de alzar refierase a las paginas 98–101.

▲Specify finish / Especificque el Acabado
*Discontinued model—some components may not be available. / Modelo descontinuado - algunos componentes pueden no estar disponibles.

Two Handle Lavatory Faucets

Llave de Dos Manijas (Manerales) para Lavamanos

Innovations® Series Model/Modelo 3530 Series

For models manufactured BEFORE September 2002 / Para los modelos fabricados ANTES de Septiembre 2002

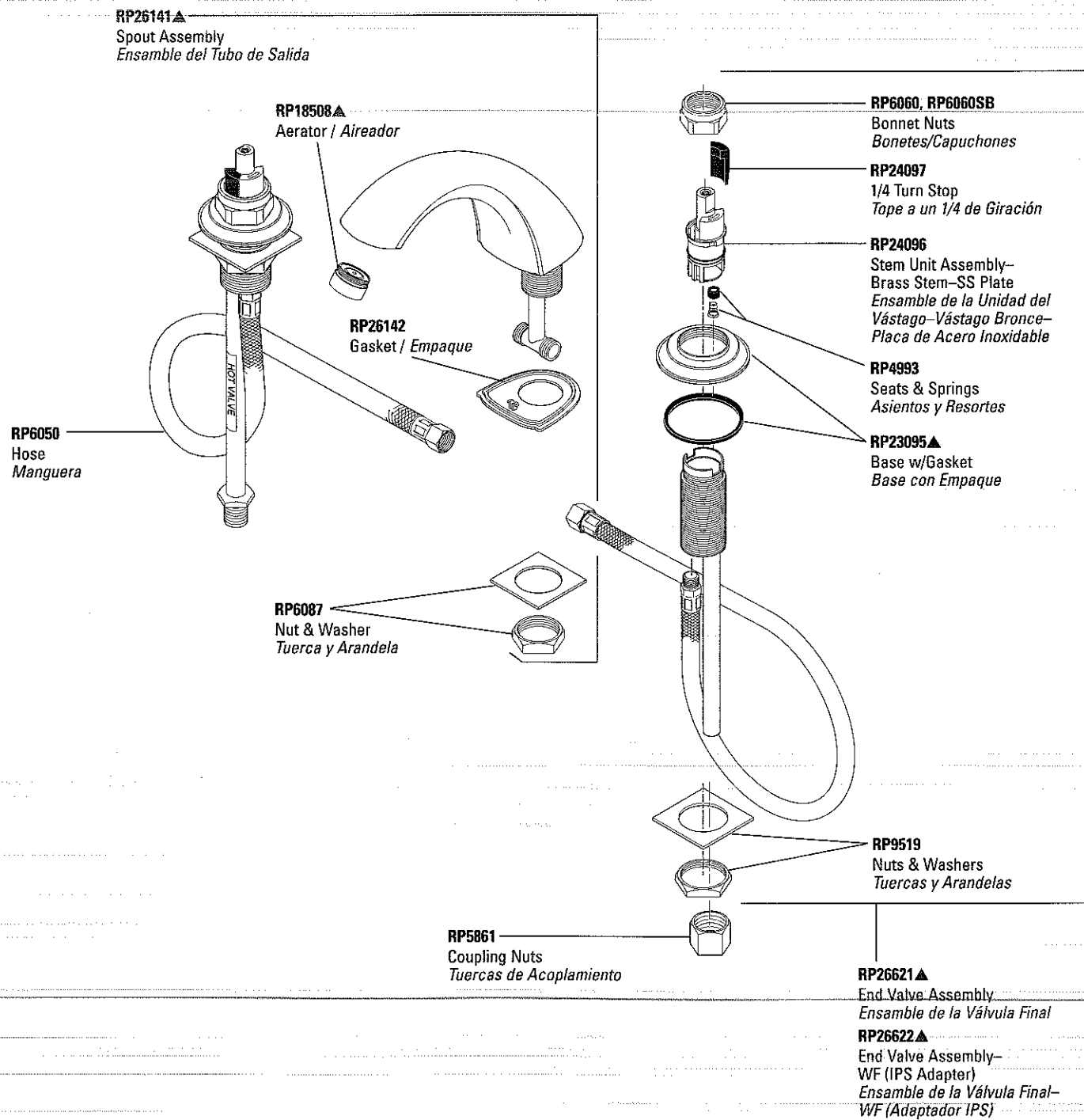

Two Handle Lavatory Faucets

Llave de Dos Manijas (Manerales) para Lavamanos

Innovations® Series Model/Modelo 3530 Series

For models manufactured AFTER September 2002 / Para los modelos fabricados DESPUÉS de Septiembre 2002

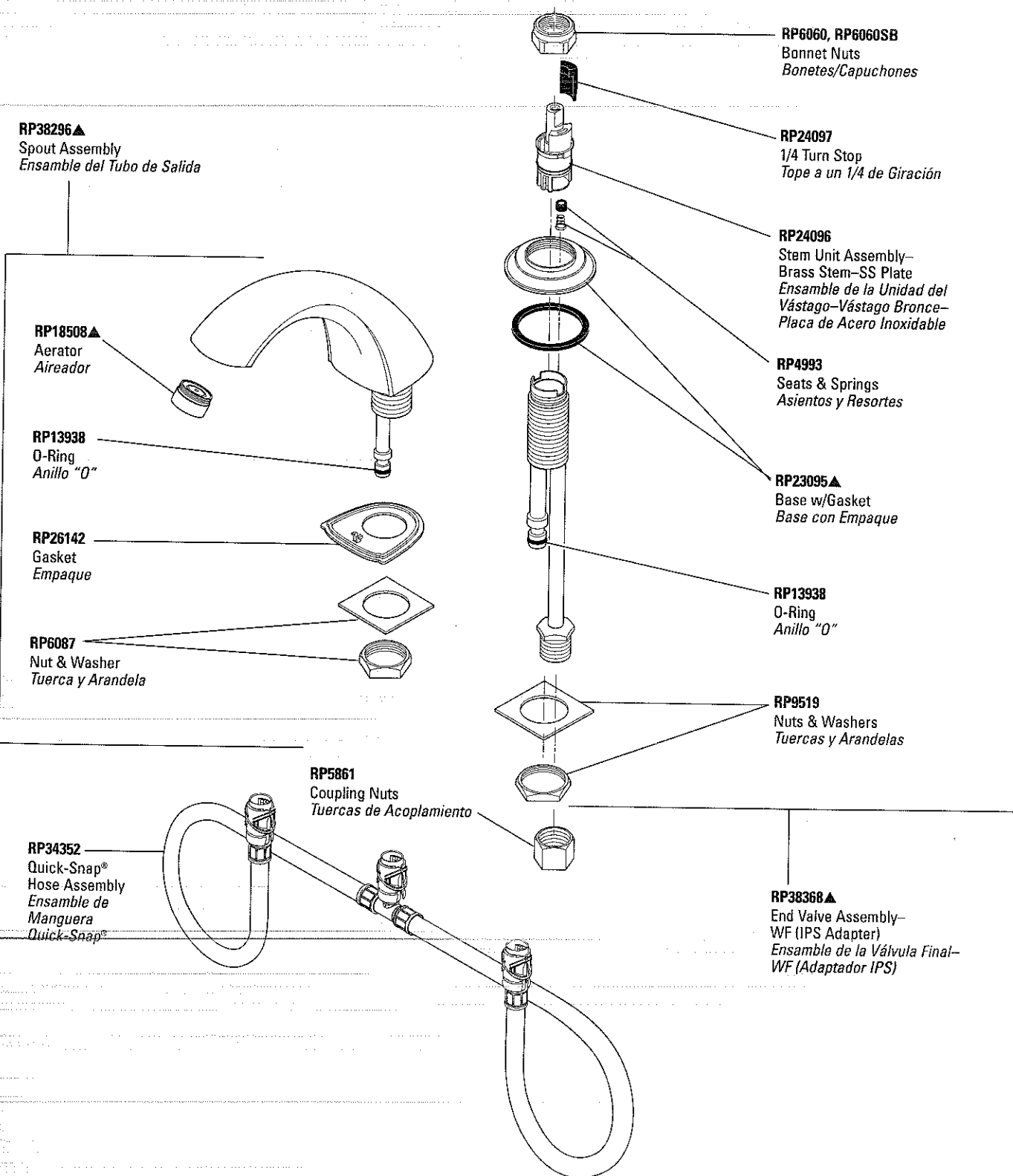

Thick deck mounting kit available as RP10612 adds 1" to shanks. / Las herramientas para la instalación en losas gruesas en el equipo RP10612 agrega 1" a las espigas.
Refer to page 96 for Handles. / Para manijas referirse a la página 96.
Refer to pages 98-101 for lift rods and lavatory drain assemblies. / Para ensamble de drenaje para lavamanos y barras de alzar referirse a las páginas 98-101.

Thick deck mounting kit available as RP10612 adds 1" to shanks. / Las herramientas para la instalación en losas gruesas en el equipo RP10612 agrega 1" a las espigas.
Refer to page 96 for Handles. / Para manijas referirse a la página 96.
Refer to pages 98-101 for lift rods and lavatory drain assemblies. / Para ensamble de drenaje para lavamanos y barras de alzar referirse a las páginas 98-101.

Two Handle Lavatory Faucets

Llave de Dos Manijas (Manerales) para Lavamanos

Classic Series Models/Modelos 3543, 3544 Series

For models manufactured BEFORE September 2002 / Para los modelos fabricados ANTES de Septiembre 2002

Two Handle Lavatory Faucets

Llave de Dos Manijas (Manerales) para Lavamanos

Classic Series Models/Modelos 3543, 3544 Series

For models manufactured AFTER September 2002 / Para los modelos fabricados DESPUÉS de Septiembre 2002

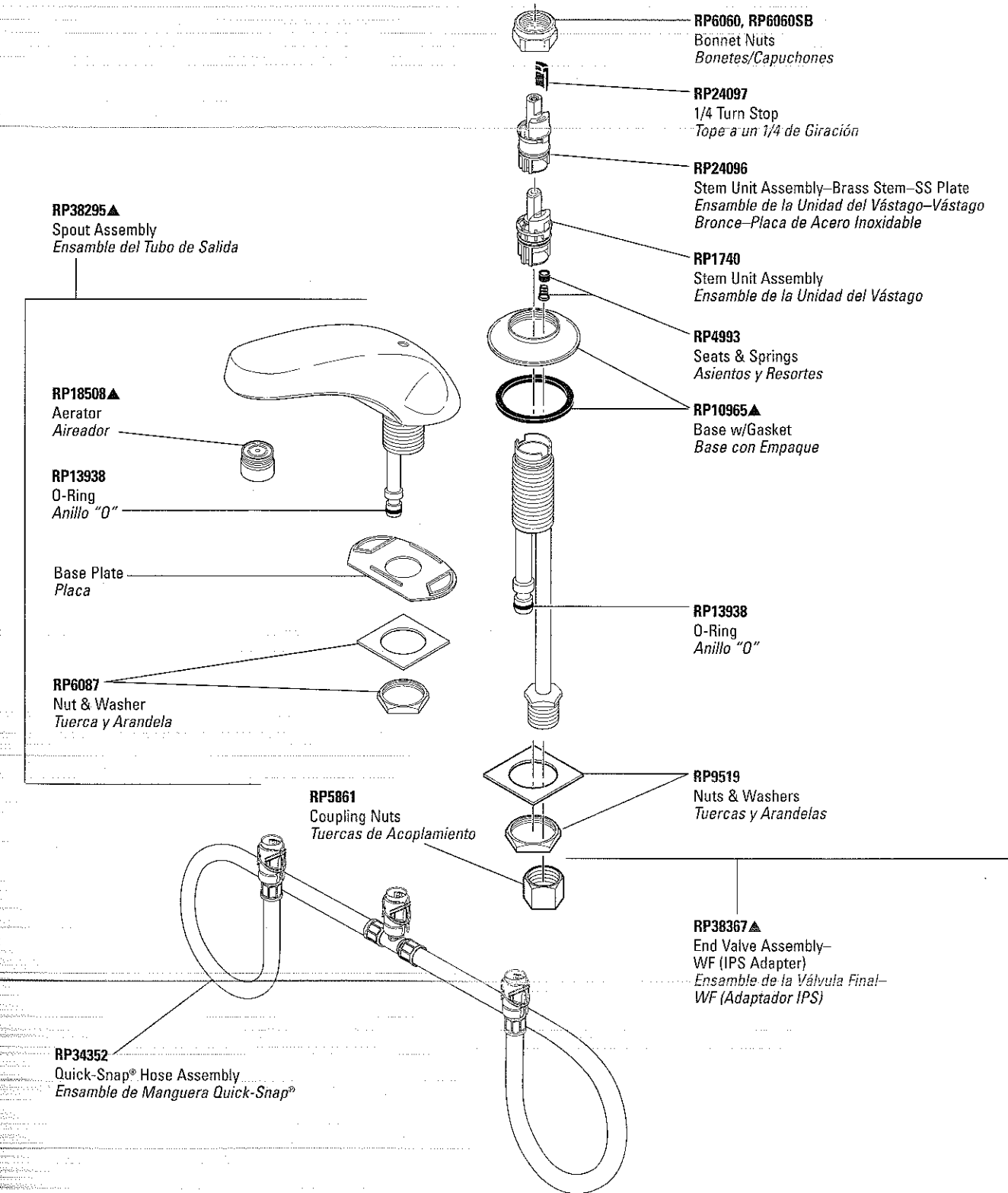
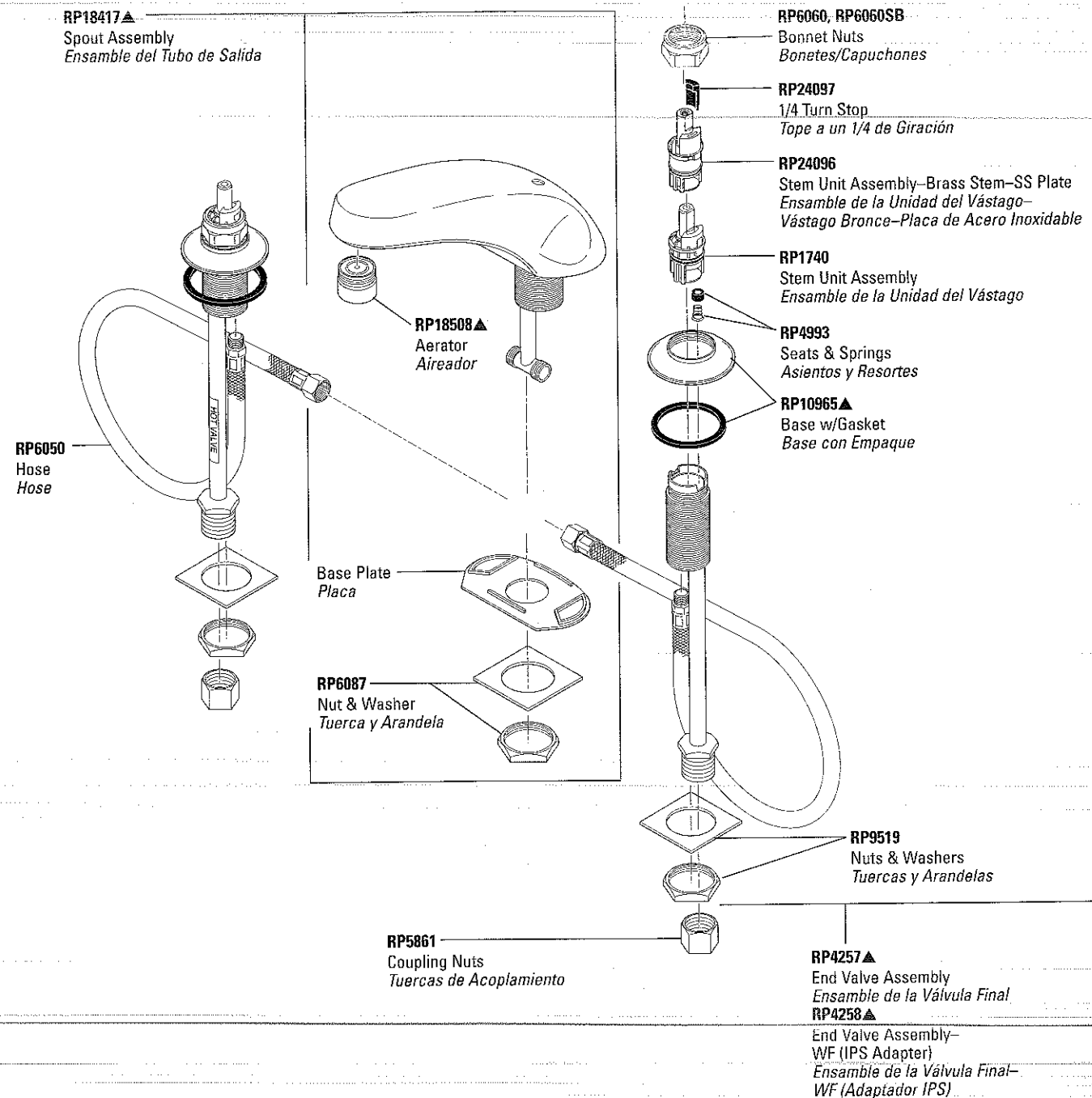

Thick deck mounting kit available as RP10612 adds 1" to shanks. / Las herramientas para la instalación en losas gruesas en el equipo RP10612 agrega 1" a las espigas.
Refer to page 96 for Handles. / Para manijas referirse a la página 96.
Refer to pages 98-101 for lift rods and lavatory drain assemblies. / Para ensamble de drenaje para lavamanos y barras de alzar referirse a las páginas 98-101.

Thick deck mounting kit available as RP10612 adds 1" to shanks. / Las herramientas para la instalación en losas gruesas en el equipo RP10612 agrega 1" a las espigas.
Refer to page 96 for Handles. / Para manijas referirse a la página 96.
Refer to pages 98-101 for lavatory drain assemblies. / Para ensamble de drenaje para lavamanos referirse a las páginas 98-101.

▲Specify finish / Especificar el Acabado

Two Handle Lavatory Faucets Llave de Dos Manijas (Manerales) para Lavamanos

Victorian™ Collection Model/Modelo 3555 Series

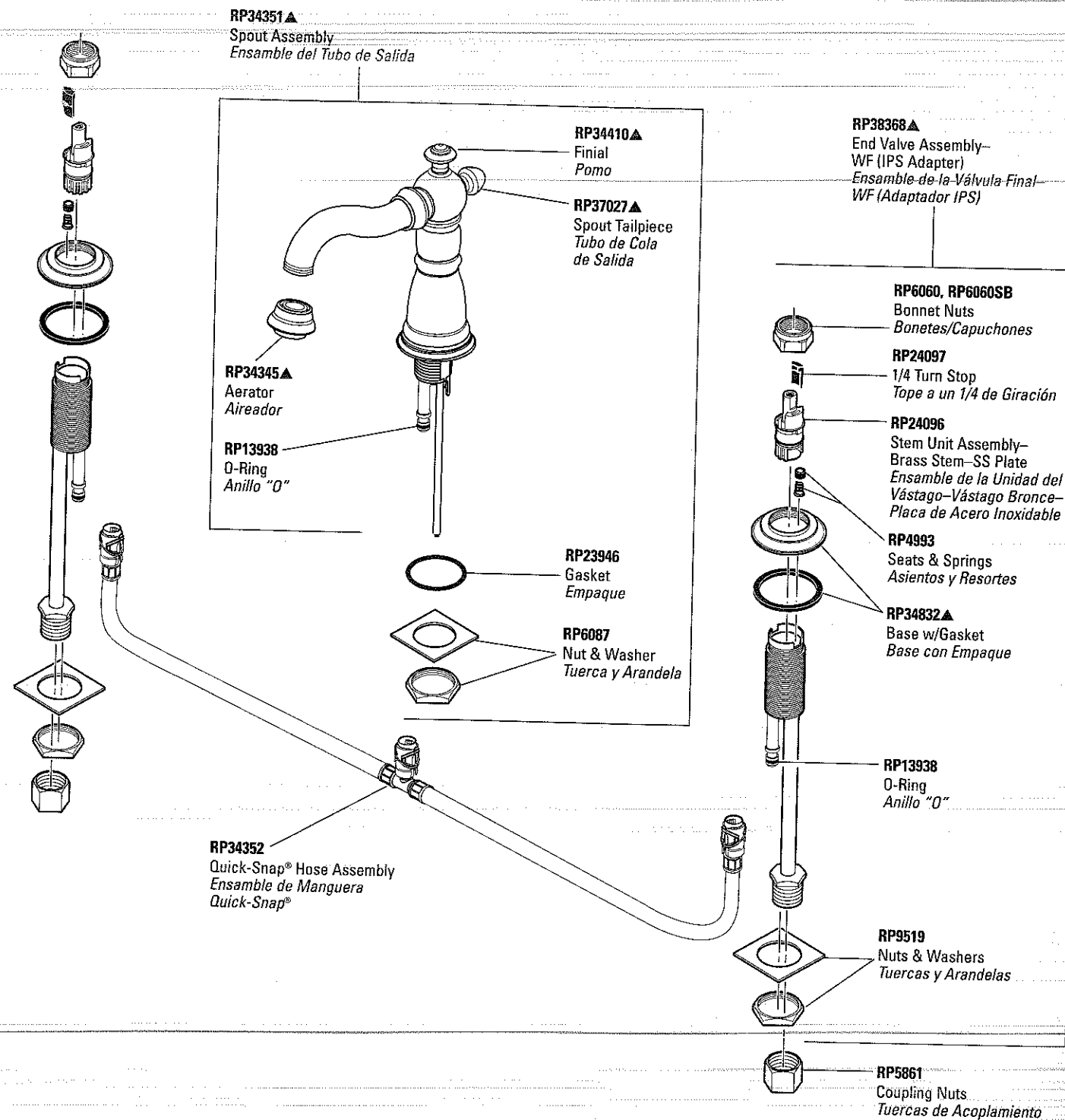

Two Handle Lavatory Faucets Llave de Dos Manijas (Manerales) para Lavamanos

Botanical™ Bath Collection
Freesia™ Series Model/Modelo 3560* Series
Statice™ Series Model/Modelo 3565 Series

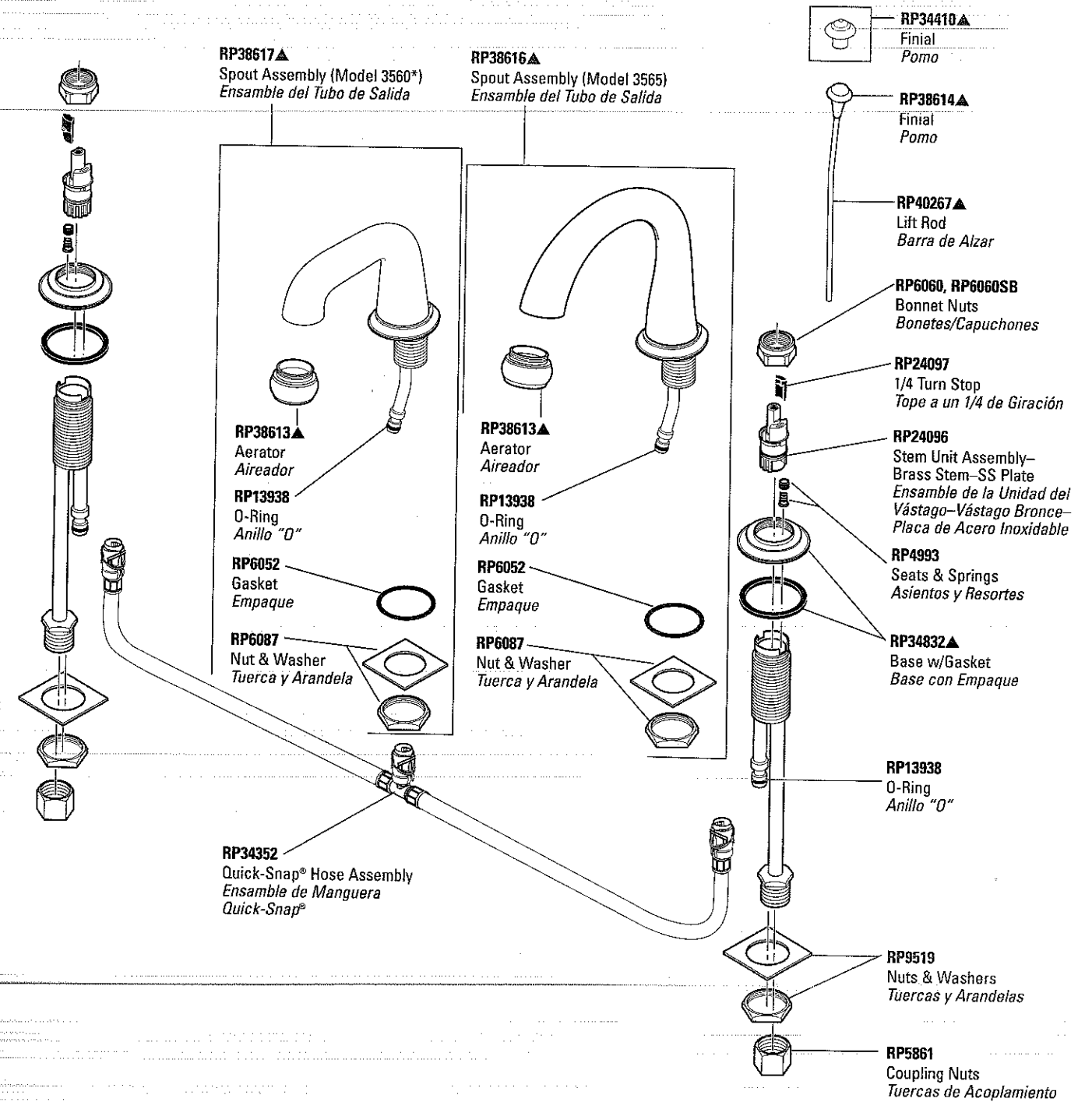

Thick deck mounting kit available as RP10612 adds 1" to shanks. / Las herramientas para la instalación en losas gruesas en el equipo RP10612 agrega 1" a las espigas.
Refer to page 96 for Handles. / Para manijas referirse a la pagina 96.
Refer to pages 100-101 for lift rods and lavatory drain assemblies. / Para ensamble de drenaje para lavamanos y barras de alzar referirse a las paginas 100-101.

Thick deck mounting kit available as RP10612 adds 1" to shanks. / Las herramientas para la instalación en losas gruesas en el equipo RP10612 agrega 1" a las espigas.
Refer to page 96 for Handles. / Para manijas referirse a la pagina 96.
Refer to pages 100-101 for lavatory drain assemblies. / Para ensamble de drenaje para lavamanos referirse a las paginas 100-101.

Two Handle Lavatory Faucets

Llave de Dos Manijas (Manerales) para Lavamanos

NEO STYLE® Series Model/Modelo 3567 Series

For models manufactured BEFORE September 2002 / Para los modelos fabricados ANTES de Septiembre 2002

Two Handle Lavatory Faucets

Llave de Dos Manijas (Manerales) para Lavamanos

NEO STYLE® Series Model/Modelo 3567 Series

For models manufactured AFTER September 2002 / Para los modelos fabricados DESPUÉS de Septiembre 2002

LAVATORY

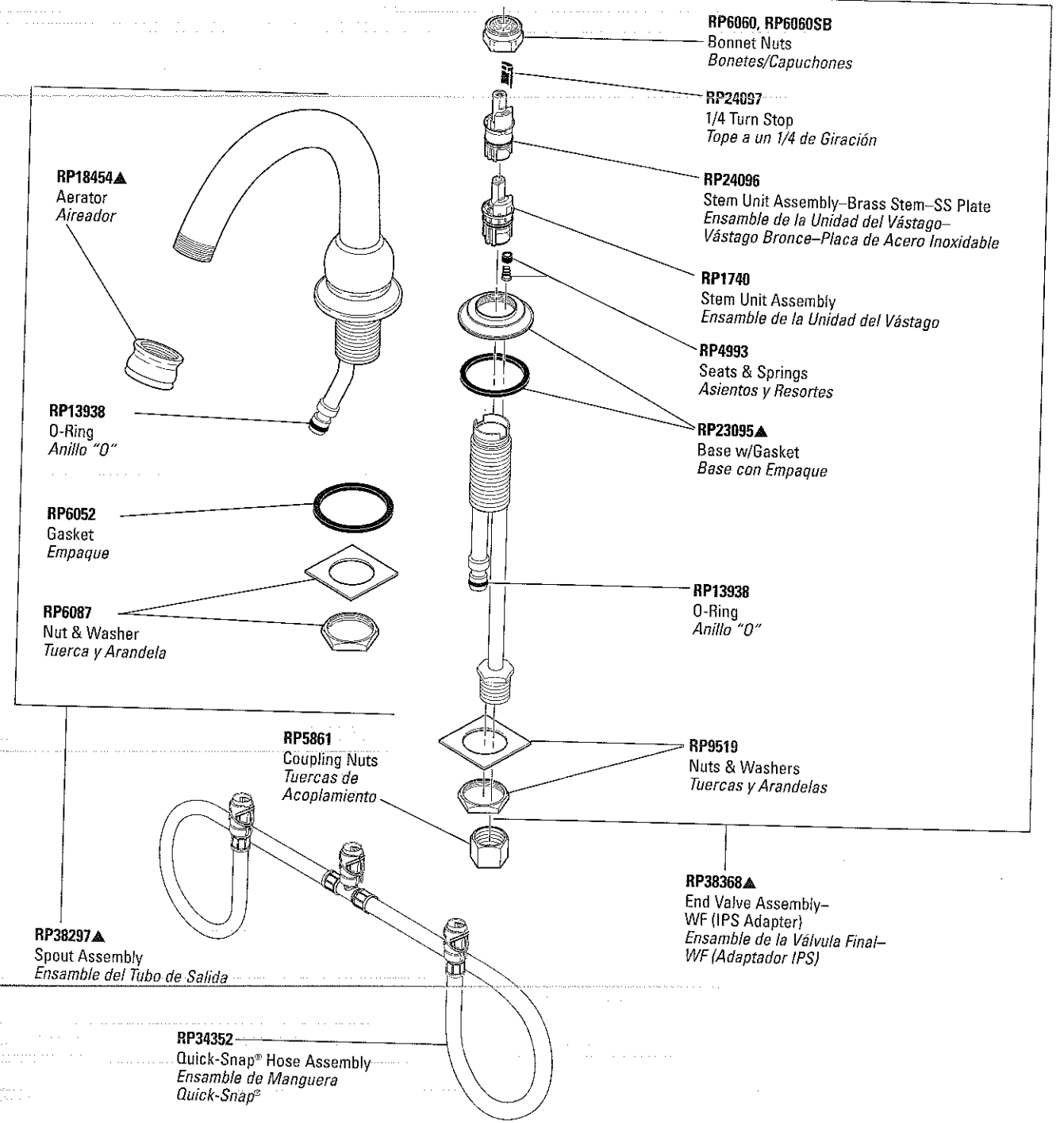
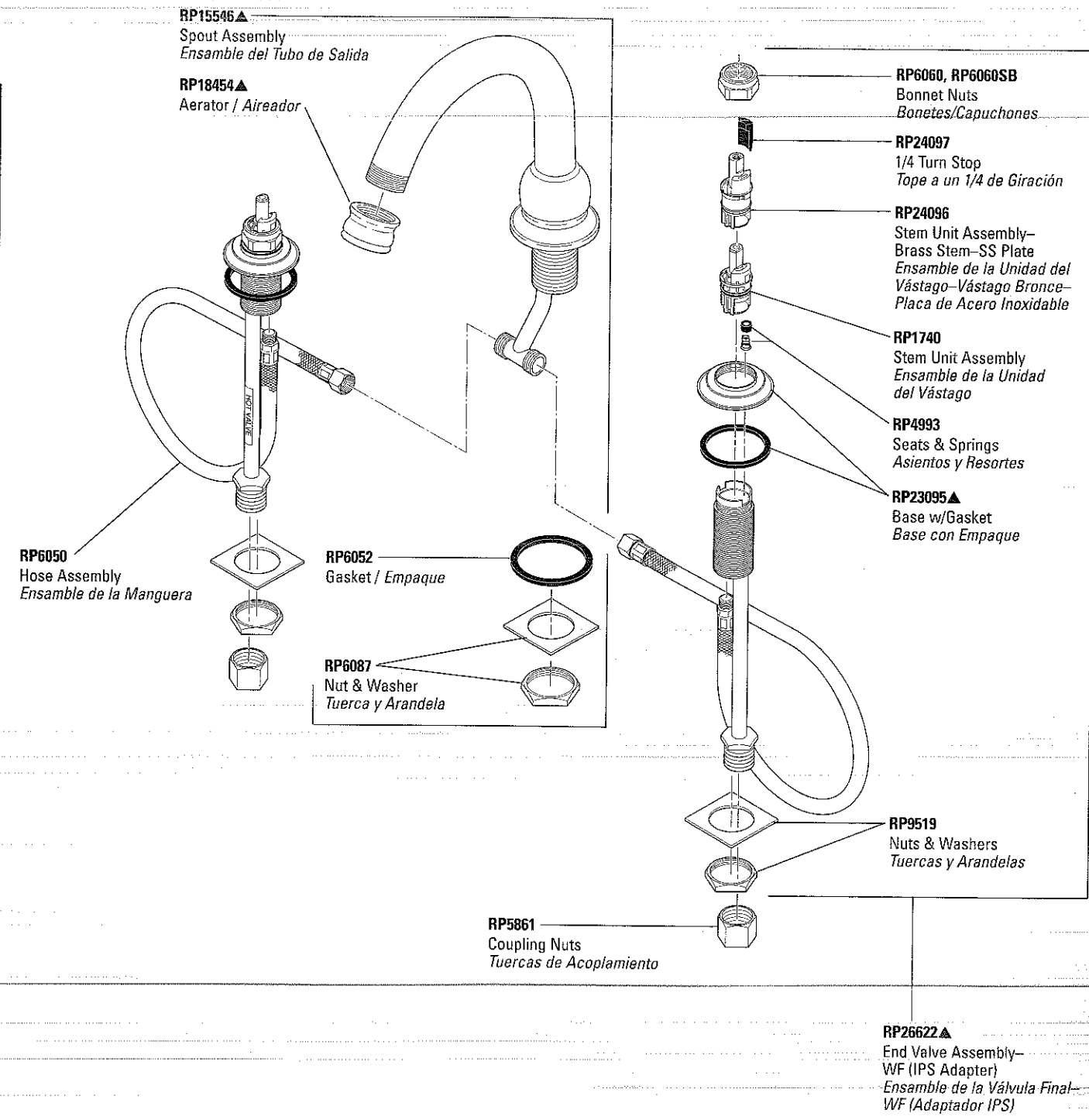

Thick deck mounting kit available as RP10612 adds 1" to shanks. / Las herramientas para la instalación en losas gruesas en el equipo RP10612 agrega 1" a las espigas.
Refer to page 96 for Handles. / Para manijas referirse a la pagina 96.
Refer to pages 98-101 for lift rods and lavatory drain assemblies. / Para ensamble de drenaje para lavamanos y barras de alzar referirse a las paginas 98-101.

Thick deck mounting kit available as RP10612 adds 1" to shanks. / Las herramientas para la instalación en losas gruesas en el equipo RP10612 agrega 1" a las espigas.
Refer to page 96 for Handles. / Para manijas referirse a la pagina 96.
Refer to pages 98-101 for lift rods and lavatory drain assemblies. / Para ensamble de drenaje para lavamanos y barras de alzar referirse a las paginas 98-101.

Two Handle Lavatory Faucets

Llave de Dos Manijas (Manerales) para Lavamanos

Teapot Spout Series Model/Modelo 3577 Series

For models manufactured BEFORE September 2002 / Para los modelos fabricados ANTES de Septiembre 2002

Two Handle Lavatory Faucets

Llave de Dos Manijas (Manerales) para Lavamanos

Teapot Spout Series Model/Modelo 3577 Series

For models manufactured AFTER September 2002 / Para los modelos fabricados DESPUÉS de Septiembre 2002

RP23097▲
Spout Assembly
Ensamble del Tubo de Salida

RP18508▲
Aerator / Aireador

RP23098▲
Base with Gasket
Base con Empaque

RP20368
Gasket / Empaque

RP6087
Nut & Washer
Tuerca y Arandela

RP11729
Gasket & O-Ring
Empaque y Anillo "O"

RP12039
Coupling Tee
Acoplamiento de "T"

RP12038
Nut / Tuerca

RP6050
Hose Assembly
Ensamble de la Manguera

RP21516
Mounting Hardware
Piezas para la Montura

RP5861
Coupling Nuts
Tuercas de Acoplamiento

RP6060, RP6060SB
Bonnet Nuts
Bonetes/Capuchones

RP24097
1/4 Turn Stop
Tope a un 1/4 de Giración

RP24096
Stem Unit Assembly—
Brass Stem—SS Plate
Ensamble de la Unidad del
Vástago—Vástago Bronce—
Placa de Acero Inoxidable

RP4993
Seats & Springs
Asientos y Resortes

RP23095▲
Base w/Gasket
Base con Empaque

RP9519
Nuts & Washers
Tuercas y Arandelas

RP26622▲
End Valve Assembly—
WF (IPS Adapter)
Ensamble de la Válvula Final—
WF (Adaptador IPS)

RP23097▲
Spout Assembly
Ensamble del Tubo de Salida

RP18508▲
Aerator
Aireador

RP23098▲
Base with Gasket
Base con Empaque

RP20368
Gasket
Empaque

RP6087
Nut & Washer
Tuerca y Arandela

RP11729
Gasket & O-Ring
Empaque y Anillo "O"

RP12038
Nut/Tuerca

RP13938
O-Ring
Anillo "O"

RP37062
Mounting Hardware
Piezas para la
Montura

RP38294
Coupling Tee
Acoplamiento de "T"

RP6060, RP6060SB
Bonnet Nuts
Bonetes/Capuchones

RP24097
1/4 Turn Stop
Tope a un 1/4 de Giración

RP24096
Stem Unit Assembly—
Brass Stem—SS Plate
Ensamble de la Unidad del
Vástago—Vástago Bronce—
Placa de Acero Inoxidable

RP4993
Seats & Springs
Asientos y Resortes

RP23095▲
Base w/Gasket
Base con Empaque

RP13938
O-Ring
Anillo "O"

RP9519
Nuts & Washers
Tuercas y Arandelas

RP38368▲
End Valve Assembly—
WF (IPS Adapter)
Ensamble de la Válvula Final—
WF (Adaptador IPS)

RP34352
Quick-Snap® Hose Assembly
Ensamble de Manguera
Quick-Snap®

RP5861
Coupling Nuts
Tuercas de Acoplamiento

Thick deck mounting kit available as RP10612 adds 1" to shanks. / Las herramientas para la instalación en losas gruesas en el equipo RP10612 agrega 1" a las espigas.
Refer to page 96 for Handles. / Para manijas referirse a la página 96.
Refer to pages 98-101 for lift rods and lavatory drain assemblies. / Para ensamble de drenaje para lavamanos y barras de alzar referirse a las páginas 98-101.

Thick deck mounting kit available as RP10612 adds 1" to shanks. / Las herramientas para la instalación en losas gruesas en el equipo RP10612 agrega 1" a las espigas.
Refer to page 96 for Handles. / Para manijas referirse a la página 96.
Refer to pages 98-101 for lift rods and lavatory drain assemblies. / Para ensamble de drenaje para lavamanos y barras de alzar referirse a las páginas 98-101.

Two Handle Lavatory Faucets

Llave de Dos Manijas (Manerales) para Lavamanos

C-Spout Series Models/Modelos 3583 & 3584* Series

For models manufactured BEFORE September 2002 / Para los modelos fabricados ANTES de Septiembre 2002

Two Handle Lavatory Faucets

Llave de Dos Manijas (Manerales) para Lavamanos

C-Spout Series Models/Modelos 3583 & 3584* Series

For models manufactured AFTER September 2002 / Para los modelos fabricados DESPUÉS de Septiembre 2002

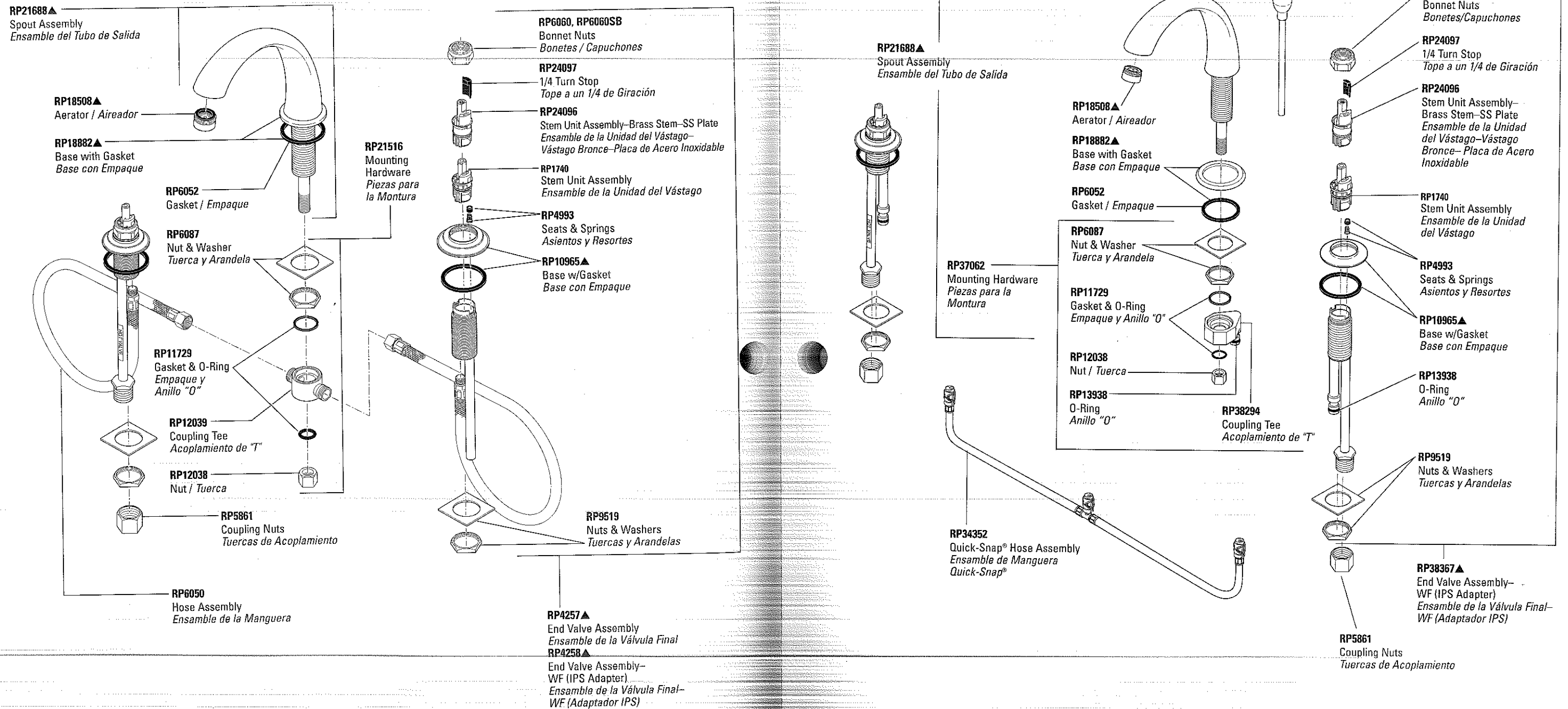

Thick deck mounting kit available as RP10612 adds 1" to shanks. / Las herramientas para la instalación en losas gruesas en el equipo RP10612 agrega 1" a las espigas.
Refer to page 96 for Handles. / Para manijas referirse a la pagina 96.
Refer to pages 98-101 for lift rods and lavatory drain assemblies. / Para ensamble de drenaje para lavamanos y barras de alzar referirse a las paginas 98-101.

Thick deck mounting kit available as RP10612 adds 1" to shanks. / Las herramientas para la instalación en losas gruesas en el equipo RP10612 agrega 1" a las espigas.
Refer to page 96 for Handles. / Para manijas referirse a la pagina 96.
Refer to pages 98-101 for lift rods and lavatory drain assemblies. / Para ensamble de drenaje para lavamanos y barras de alzar referirse a las paginas 98-101.

Two Handle Lavatory Faucets

Llave de Dos Manijas (Manerales) para Lavamanos

Two Handle Lavatory Faucets

Llave de Dos Manijas (Manerales) para Lavamanos

MICHAEL GRAVES
COLLECTION

Model/Modelo 3588 Series

Innovations® Series Model/Modelo 4530 Series

RP6060, RP6060SB
Bonnet Nuts
Bonetes/Capuchones

RP24097
1/4 Turn Stop
Tope a un 1/4 de Giración

RP24096
Stem Unit Assembly—
Brass Stem—SS Plate
Ensamble de la Unidad del
Vástago—Vástago Bronce—
Placa de Acero Inoxidable

RP4993
Seats & Springs
Asientos y Resortes

RP40134▲
Base w/Gasket
Base con Empaque

RP40133▲
Aerator
Aireador

RP40136▲
Spout Assembly
Ensamble del Tubo
de Salida

RP13938
O-Ring
Anillo "O"

RP40137
Gasket
Empaque

RP13938
O-Ring
Anillo "O"

RP6087
Nut & Washer
Tuerca y Arandela

RP34352
Quick-Snap® Hose Assembly
Ensamble de Manguera Quick-Snap®

RP9519
Nuts & Washers
Tuercas y Arandelas

RP5861
Coupling Nuts
Tuercas de Acoplamiento

RP40131▲
Finial
Pomo

RP40267▲
Lift Rod
Barra de Alzar

RP26140▲
Spout Assembly
Ensamble del Tubo de Salida

RP26148, RP26148SB
Bonnet Nuts
Bonetes/Capuchones

RP24097
1/4 Turn Stop
Parada (Tope) a un 1/4 de Rotación

RP24096
Stem Unit Assembly—
Brass Stem—SS Plate
Ensamble de la Unidad del
Vástago—Vástago Bronce—
Placa de Acero Inoxidable

RP4993
Seats & Springs
Asientos y Resortes

RP26146▲
Handle Base, Snap Ring & Gasket
Base de la Manija, Aro de Resorte
y Empaque

RP26147▲
Base w/Gasket
Base con Empaque

RP6087
Nut & Washer
Tuerca y Arandela

RP13938
O-Ring
Anillo "O"

RP26149
Locknut
Contratuerca

RP5861
Coupling Nuts
Tuercas de Acoplamiento

GH290▲ Metal / Metal
GH291▲ Glass / Vidrio

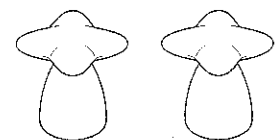

GH288▲ Metal / Metal
GH289▲ Glass / Vidrio

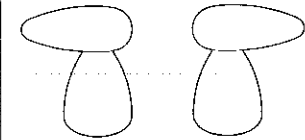

RP10612
Thick Deck Mounting Kit (Included)
Incluye Herramienta para la instalación
en borde grueso



Refer to page 96 for Handles. / Para manijas referirse a la página 96.

Refer to pages 100-101 for lavatory drain assemblies. / Para ensamble de drenaje para lavamanos referirse a las páginas 100-101.

Refer to page 96 for Handles. / Para manijas referirse a la página 96.

Refer to pages 98-101 for lift rods and lavatory drain assemblies. / Para ensamble de drenaje para lavamanos y barras de alzar referirse a las páginas 98-101.

Two Handle Lavatory Faucets

Llave de Dos Manijas (Manerales) para Lavamanos

Victorian™ Collection Model/Modelo 4555 Series

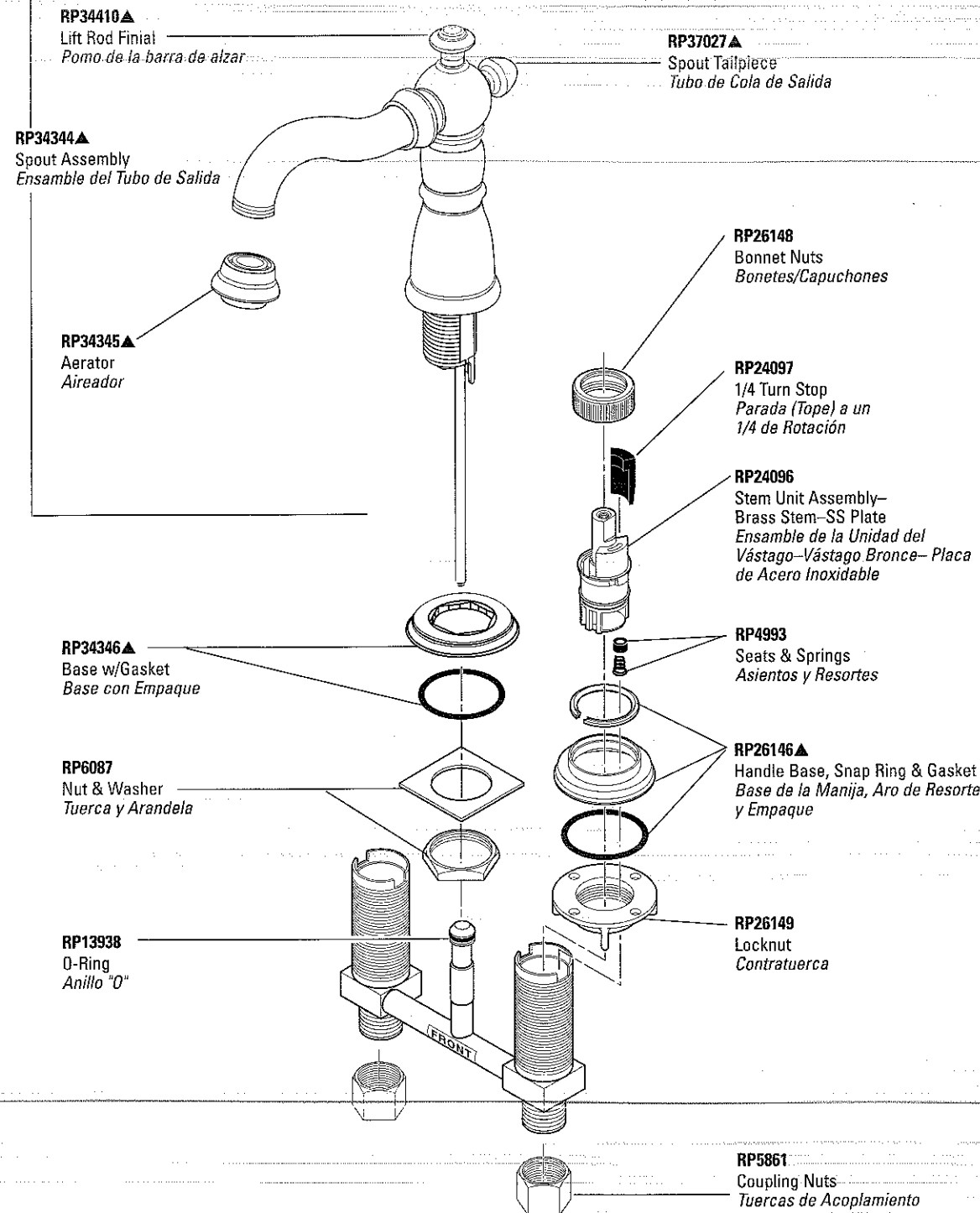

Two Handle Lavatory Faucets

Llave de Dos Manijas (Manerales) para Lavamanos

Teapot Spout Series Model/Modelo 4577 Series

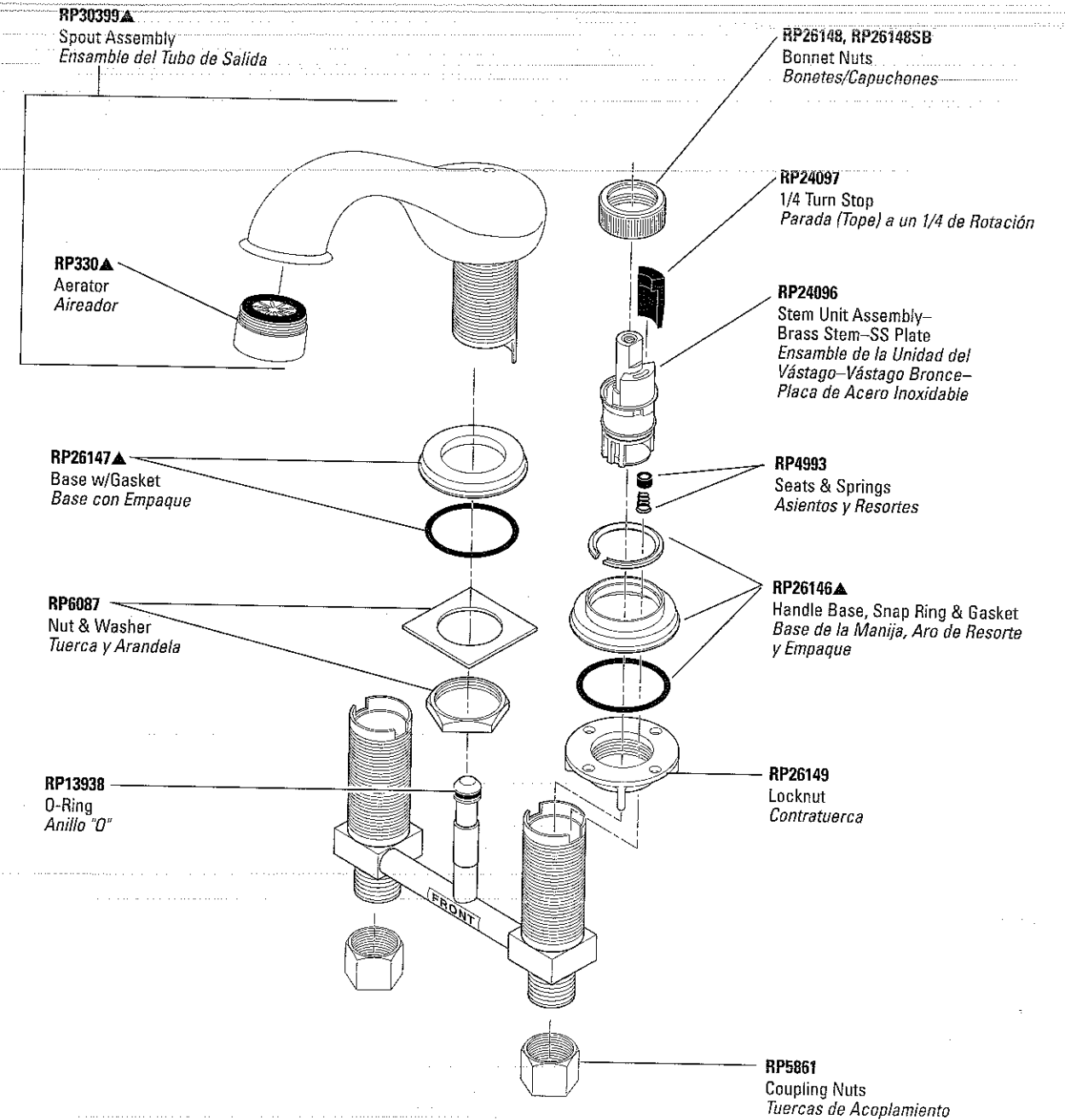

Refer to page 96 for Handles. / Para manijas referirse a la página 96.
Refer to pages 100-101 for lavatory drain assemblies. / Para ensamble de drenaje para lavamanos referirse a las páginas 100-101.

Refer to page 96 for Handles. / Para manijas referirse a la página 96.
Refer to pages 98-101 for lift rods and lavatory drain assemblies. / Para ensamble de drenaje para lavamanos y barras de alzar referirse a las páginas 98-101.

Two Handle Lavatory Faucets

Llave de Dos Manijas (Manerales) para Lavamanos

Notes / Notas

MICHAEL GRAVES
COLLECTION

Model/Modelo 4588 Series

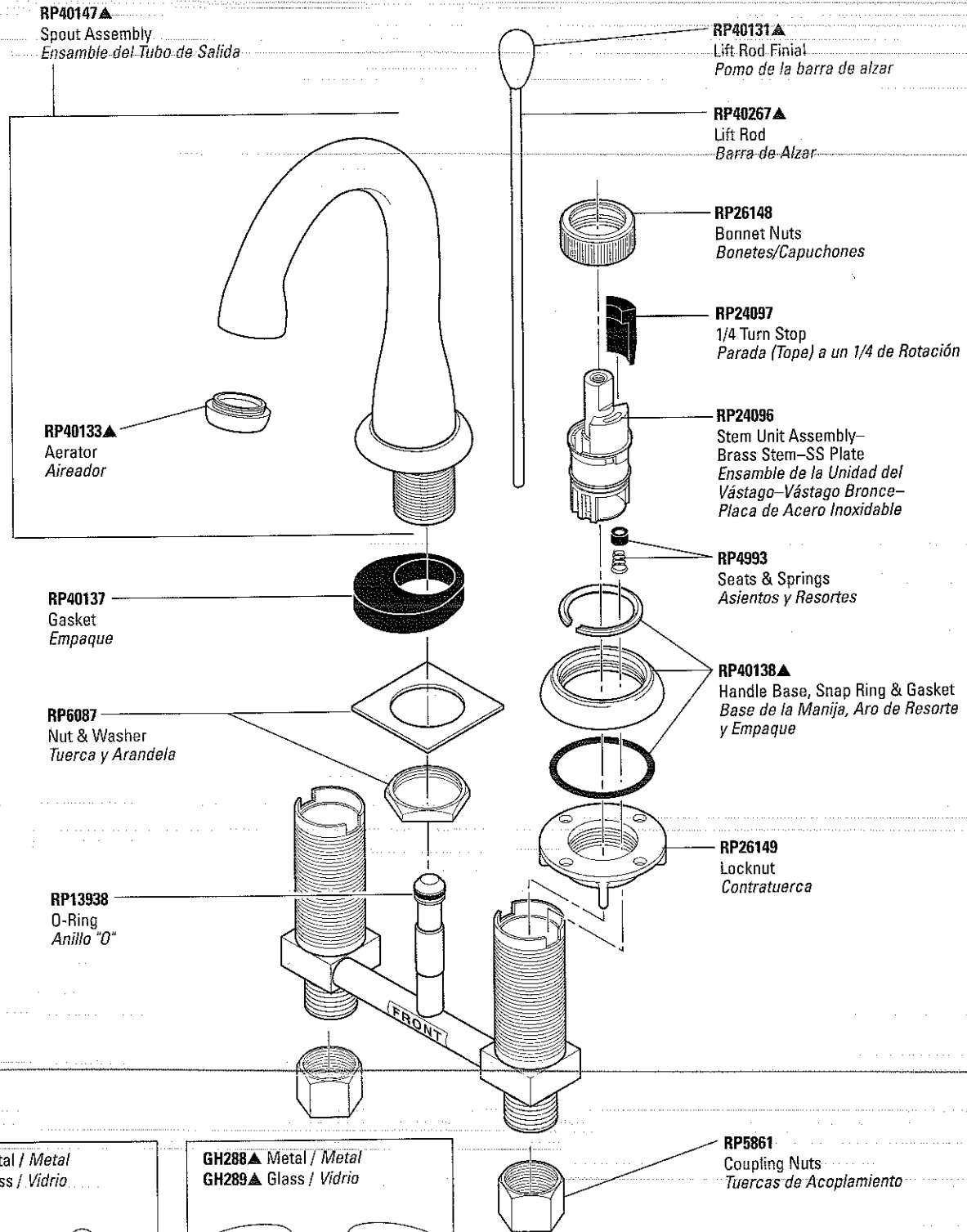

Refer to pages 100-101 for lavatory drain assemblies. / Para ensamble de drenaje para lavamanos referirse a las paginas 100-101.

Specialty Faucets Llaves de Especialidad

Shampoo Valve Model/Modelo 560* Series

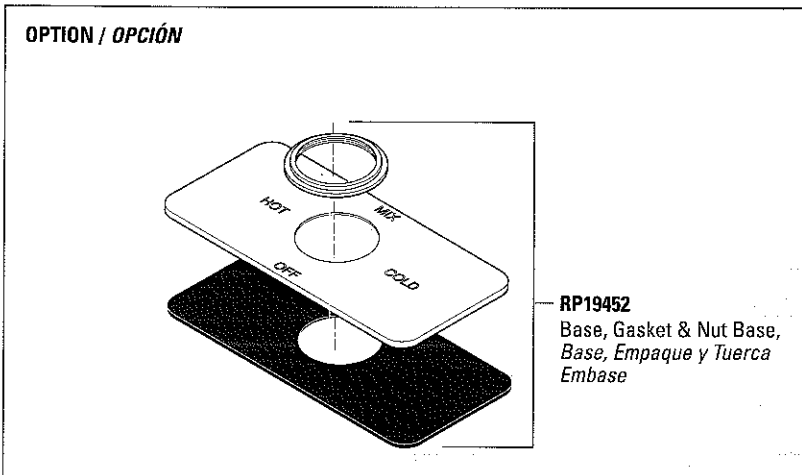
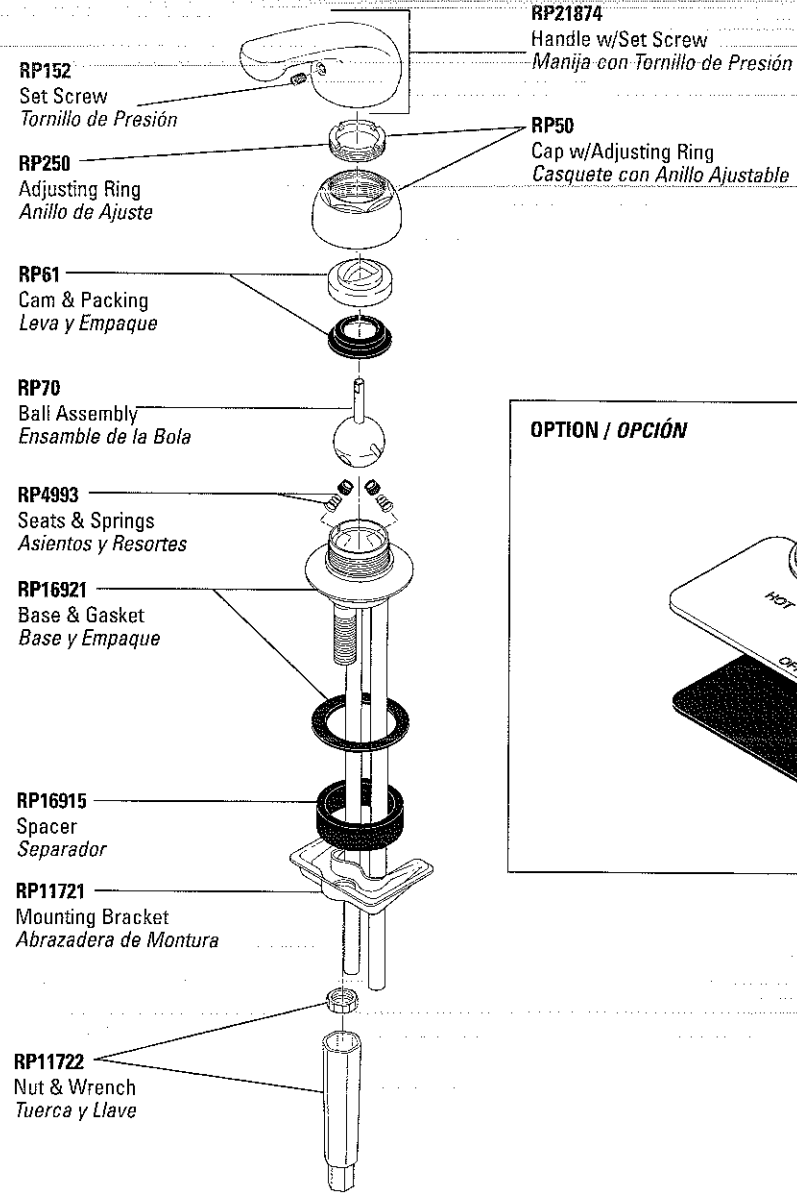

Specialty Faucets Llaves de Especialidad

Shampoo Valve Model/Modelo 562 Series

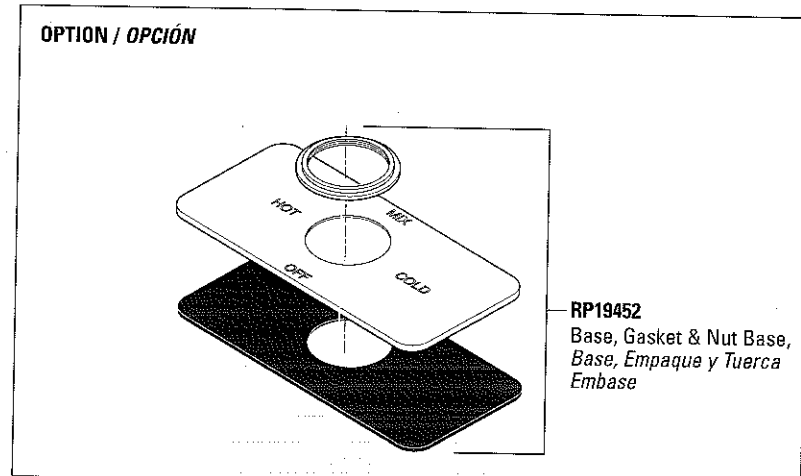
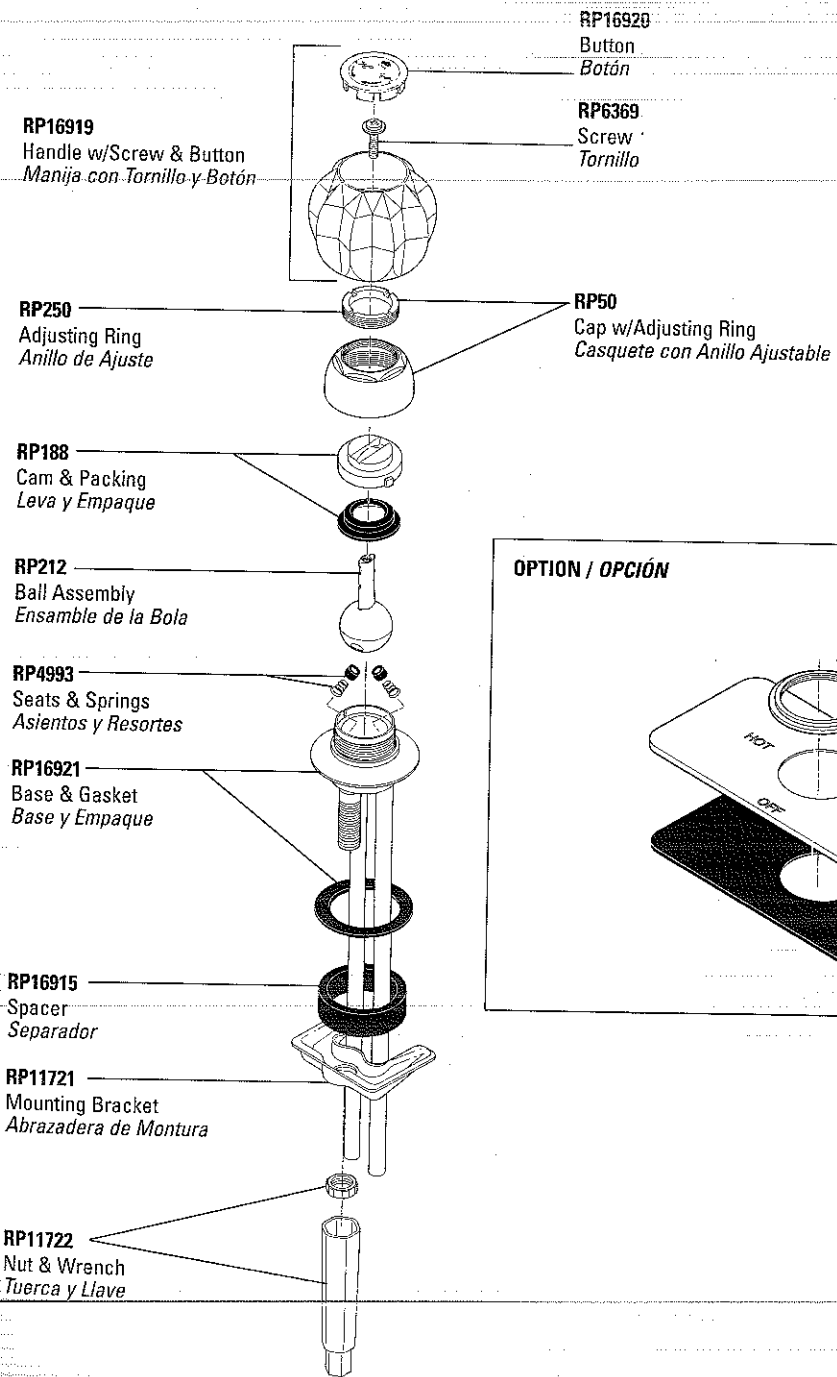

Specialty Faucets Llaves de Especialidad

Handi-Lav® Utility Series Model/Modelo 750 Series

For Models manufactured BEFORE September 2002 / Para los modelos fabricados ANTES de Septiembre 2002

Specialty Faucets Llaves de Especialidad

Handi-Lav® Utility Series Model/Modelo 750 Series

For Models manufactured AFTER September 2002 / Para los modelos fabricados DESPUÉS de Septiembre 2002

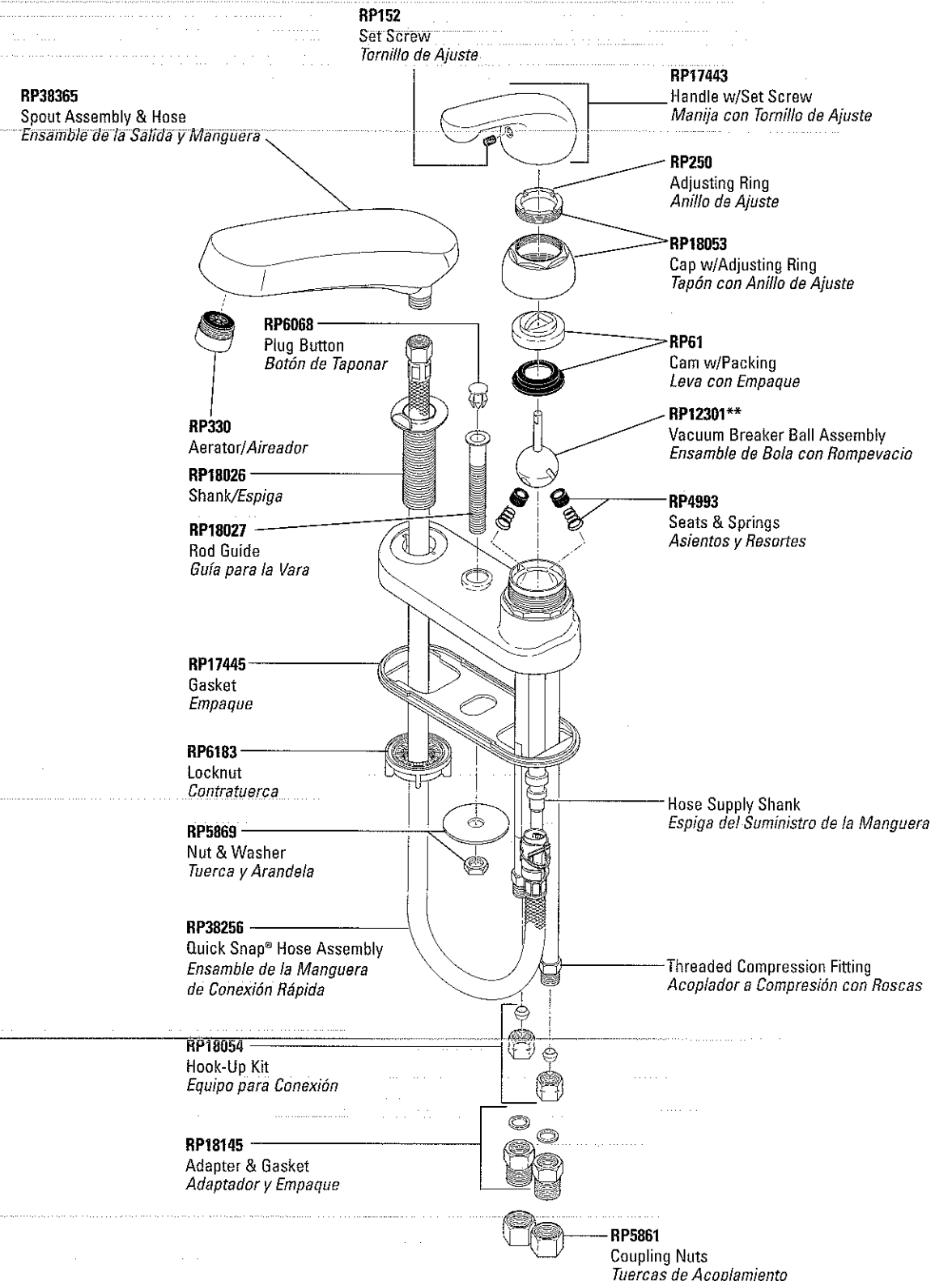
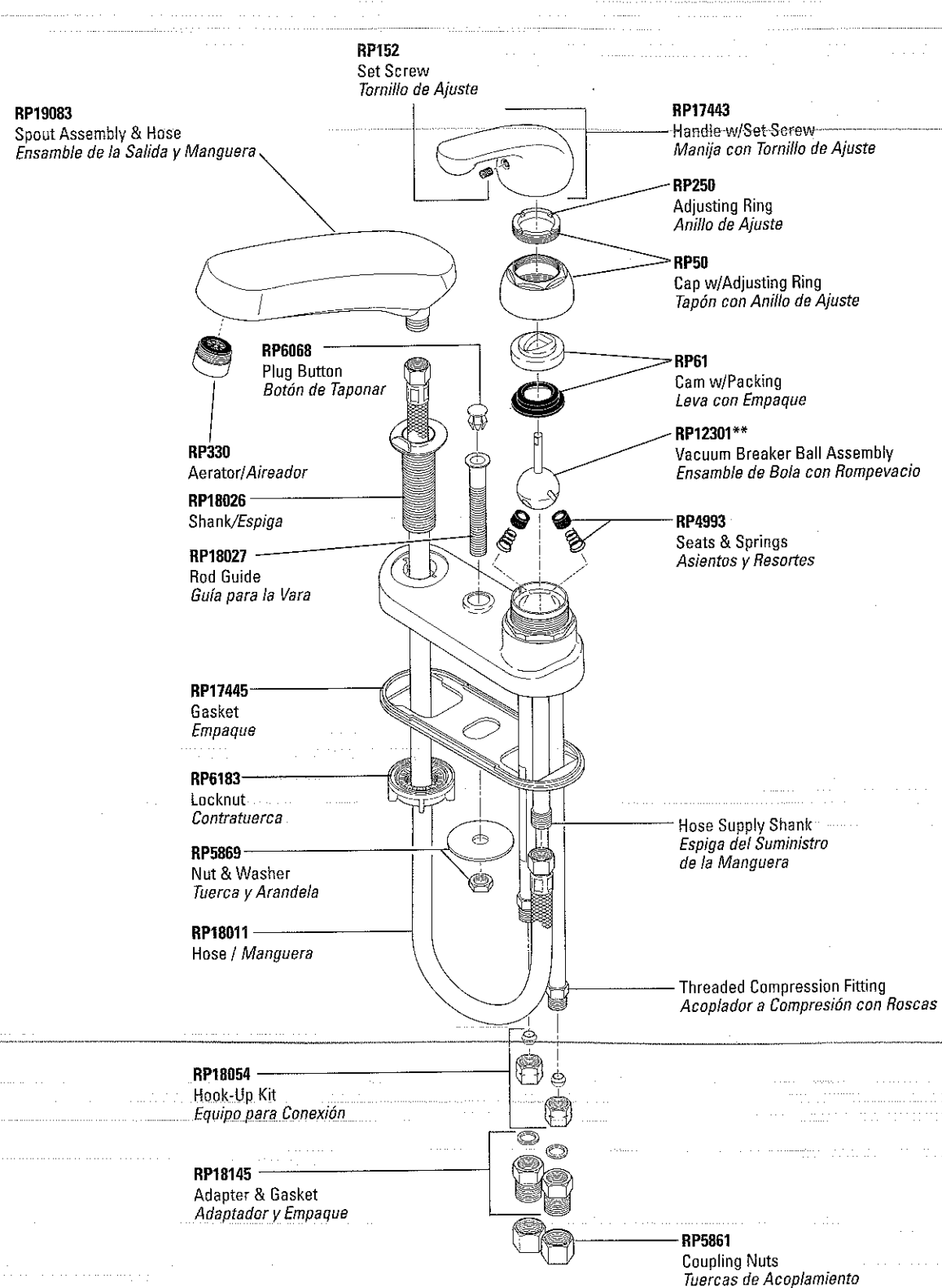

** The vacuum breaker ball assembly is an important part of protecting your drinking water from contamination by back siphonage. Use only the Delta RP12301 ball assembly.
** El ensamble de la bola rompedora de vacío es una parte importante en la protección de su agua potable contra antisifonaje. Use solamente el ensamble de bola de Delta RP12301.

** The vacuum breaker ball assembly is an important part of protecting your drinking water from contamination by back siphonage. Use only the Delta RP12301 ball assembly.
** El ensamble de la bola rompedora de vacío es una parte importante en la protección de su agua potable contra antisifonaje. Use solamente el ensamble de bola de Delta RP12301.

Specialty Faucets Llaves de Especialidad

Handi-Lav® Utility Series Model/Modelo 752* Series

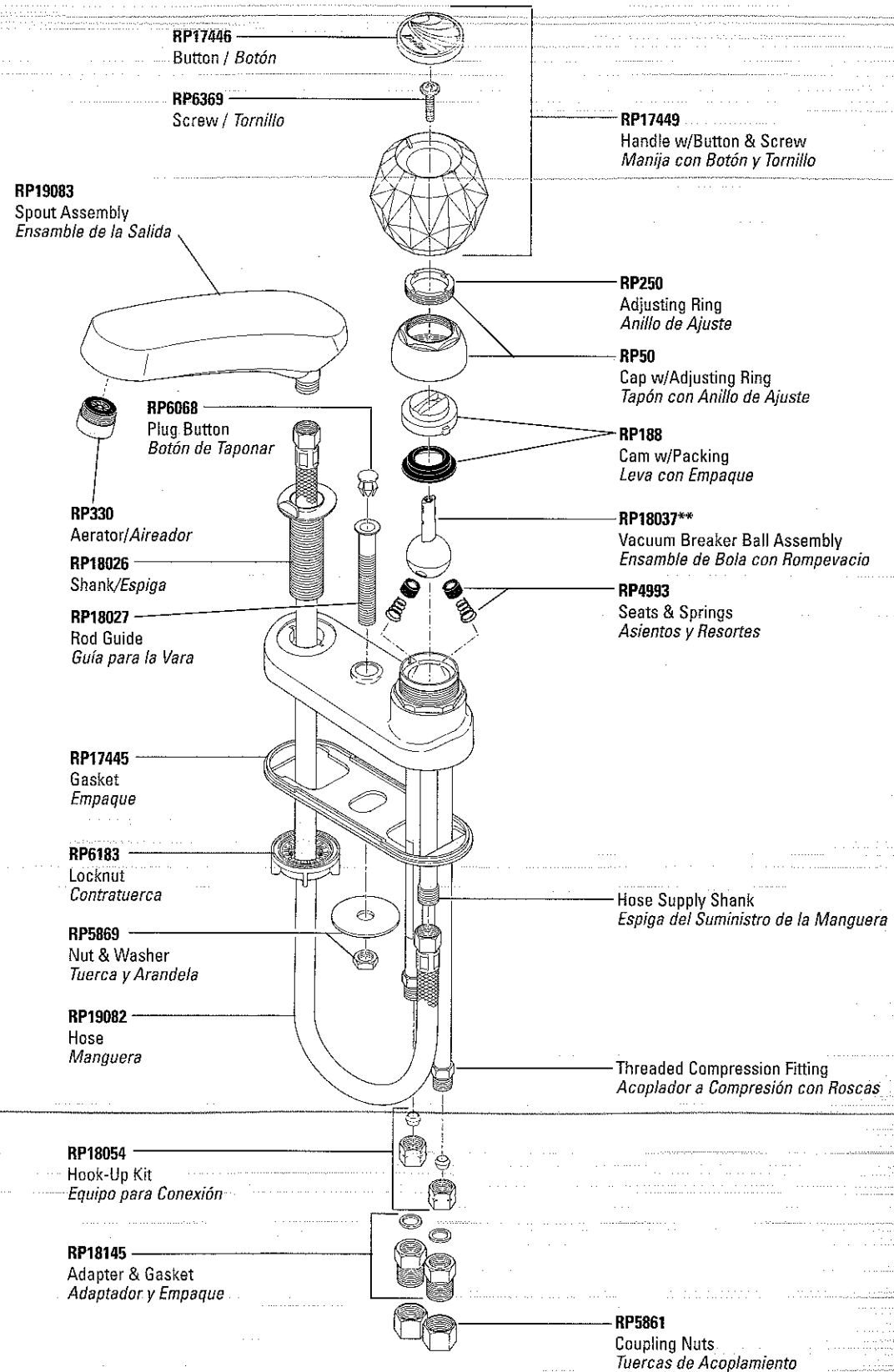

Specialty Faucets Llaves de Especialidad

Laundry Series Models/Modelos 2121 & 2123 Series

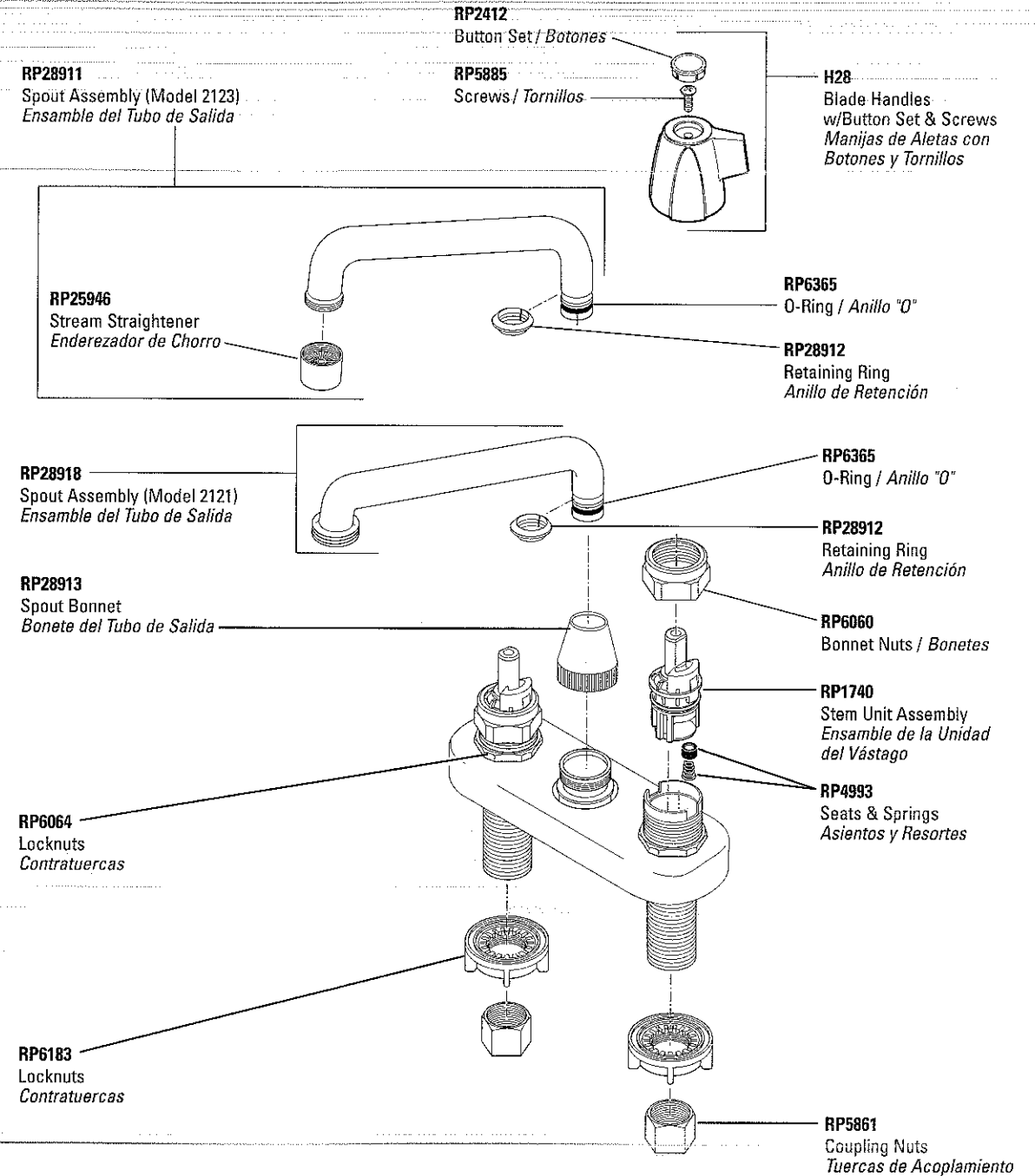

** The vacuum breaker ball assembly is an important part of protecting your drinking water from contamination by back siphonage. Use only the Delta RP18037 ball assembly.

** El ensamble de la bola rompedora de vacío es una parte importante en la protección de su agua potable contra antisifonaje. Use solamente el ensamble de bola de Delta RP18037.

Specialty Faucets Llaves de Especialidad

Specialty Faucets Llaves de Especialidad

Laundry Series Models/Modelos 2131 & 2133 Series

Basin Series Model/Modelo 2302 Series

SPECIALTY

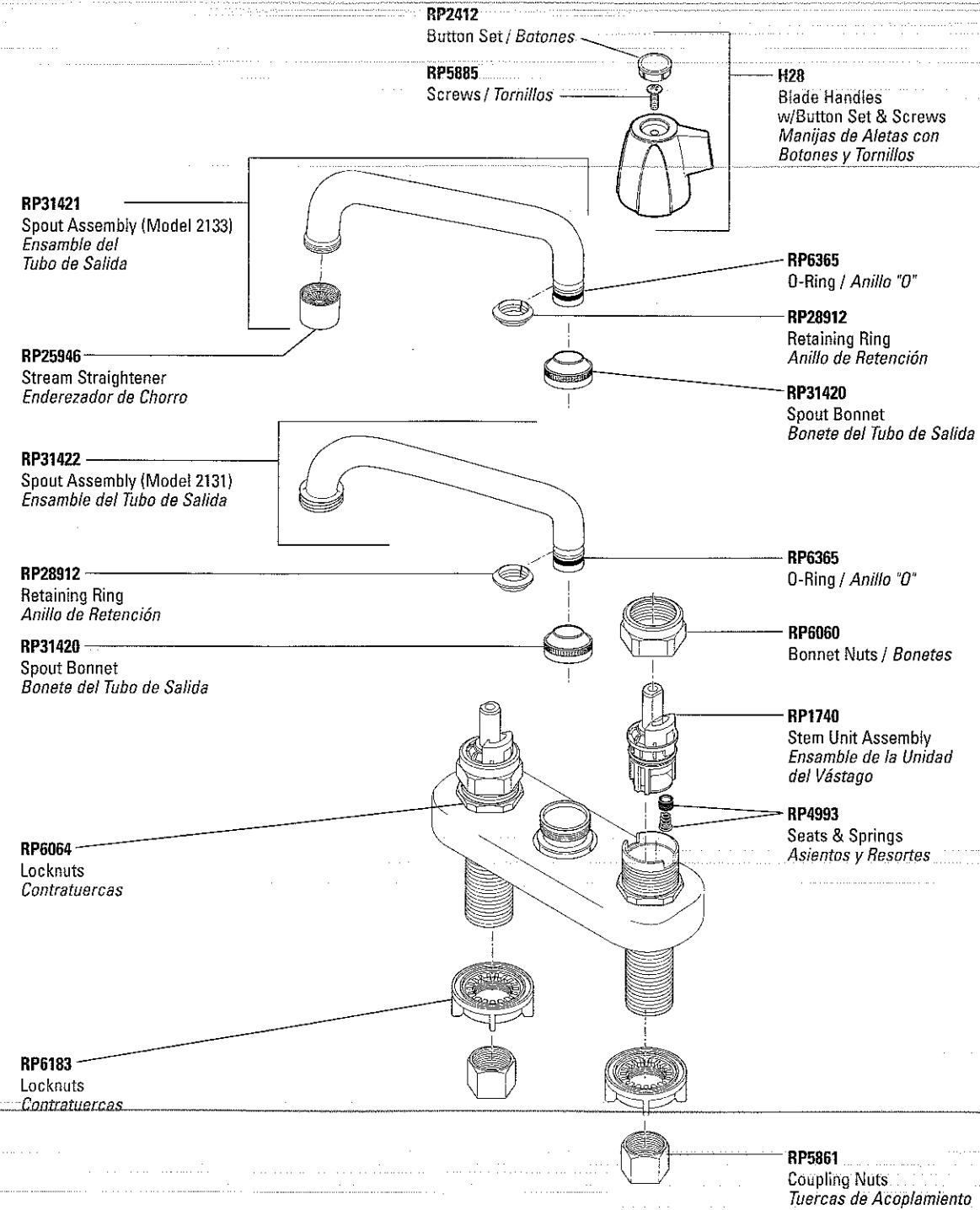

SPECIALTY

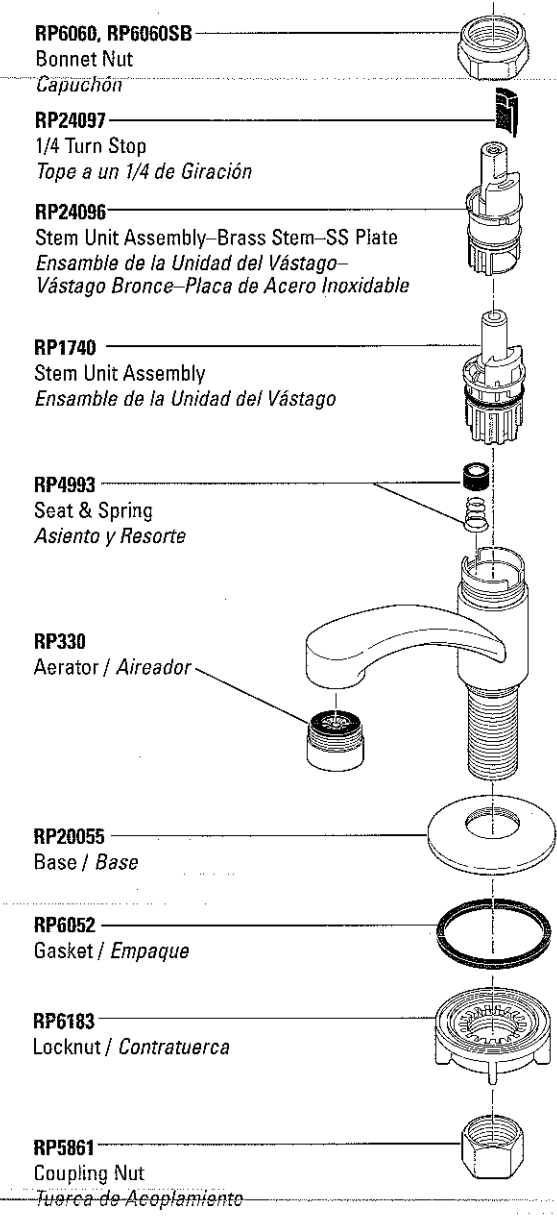

Refer to page 164 for Handles. / Para manijas referirse a la pagina 164.

Lavatory Faucet Handles and Accents

Manijas y Accesorios para Llaves de Agua de Lavamanos

Installation Aids/Repair Kits

Herramientas para la Instalación/Herramientas de Repuesto

LAVATORY

LAVATORY

H21, H21PB
Clear Knob Handles w/Buttons & Screws
Perillas Transparente con Botones y Tornillos

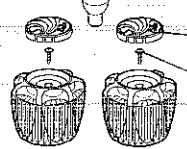

RP27644▲
Finial / Botón para la Barra del Desagüe

RP18373, RP18373PB
Button Set (Red/Blue Indicators)
Botones (Indicadores: Rojo/Azul)

RP5885
Screws / Tornillos

H41, H41PB
Clear Knob Handles w/Buttons & Screws
Perillas Transparente con Botones y Tornillos

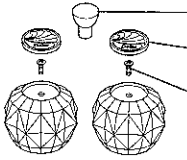

RP27644▲
Finial / Botón para la Barra del Desagüe

RP18373, RP18373PB
Button Set (Red/Blue Indicators)
Botones (Indicadores: Rojo/Azul)

RP5885
Screws / Tornillos

H28
Metal Blade Handles w/Buttons & Screws
Manijas de Manga de Metal con Botones y Tornillos

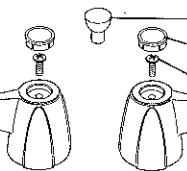

RP27644▲
Finial/Botón para la Barra del Desagüe

RP2412
Button Set / Botones

RP5885
Screws / Tornillos

H48
Metal Knob Handles w/Buttons & Screws
Perillas de Metal con Botones y Tornillos

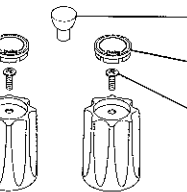

RP27644▲
Finial/Botón para la Barra del Desagüe

RP19659
Button Set (Red/Blue Indicators)
Botones (Indicadores: Rojo/Azul)

RP5885
Screws / Tornillos

H22▲
Standard Lever Handles w/Screws
Manijas Estilo Palancas Estándares con Tornillos

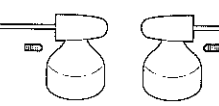

RP26851▲
Spindle / Husillo

RP25620
Set Screws / Tornillos de Ajuste

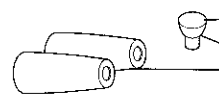

RP27644▲
Finial / Botón para la Barra del Desagüe

A22▲
Handle Accents
Acentos para Manijas

H24▲
Innovations® Lever Handles w/Screws
Manijas Estilo Palanca Innovations® con Tornillos

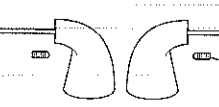

RP26852▲
Spindle / Husillo

RP25620
Set Screws / Tornillos de Ajuste

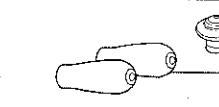

RP34410▲
Finial / Botón para la Barra del Desagüe

A24▲
Handle Accents / Acentos para Manijas

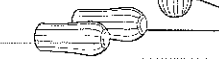

A24CL
Handle Accents / Acentos para Manijas

H25▲
Neo Style® Lever Handles w/Screws
Manijas Estilo Palanca Neo Style® con Tornillos

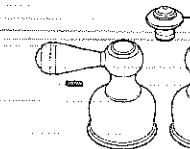

RP34410▲
Finial / Botón para la Barra del Desagüe

RP25620
Set Screws / Tornillos de Ajuste

H26▲
Neo Style® Metal Cross Handles w/Screws
Manijas de Metal en Forma de Cruz Neo Style® con Tornillos

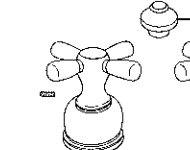

RP24588▲
Finial / Botón para la Barra del Desagüe

RP25620
Set Screws / Tornillos de Ajuste

H27▲
Neo Style® Porcelain Cross Handles w/Screws
Manijas de Porcelana en Forma de Cruz Neo Style® con Tornillos

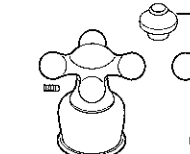

RP24588▲
Finial / Botón para la Barra del Desagüe

RP25620
Set Screws / Tornillos de Ajuste

H212▲
Traditional Porcelain Lever Handles w/Screws
Manijas Tradicionales Estilo Palanca de Porcelana con Tornillos

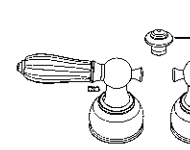

RP34410▲
Finial / Botón para la Barra del Desagüe

RP25620
Set Screws / Tornillos de Ajuste

H215▲
Traditional Metal Lever Handles w/Screws
Manijas Tradicionales Estilo Palanca de Metal con Tornillos

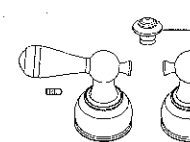

RP34410▲
Finial / Botón para la Barra del Desagüe

RP25620
Set Screws / Tornillos de Ajuste

H216▲
Victorian™ Lever Handles w/Screws
Manijas Estilo Palanca Victorian™ con Tornillos

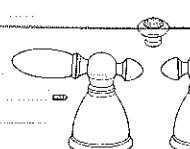

RP34410▲
Finial / Botón para la Barra del Desagüe

RP25620
Set Screws / Tornillos de Ajuste

H217▲
Botanical™ Lever Handles w/Screws
Manijas Estilo Palanca Botanical™ con Tornillos

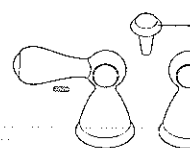

RP38614▲
Finial / Botón para la Barra del Desagüe

RP25620
Set Screws / Tornillos de Ajuste

RP39377
Small Botanical™ Color Accents for H217

Accesorios pequeños de Colores para las Manijas H217 Botanical™

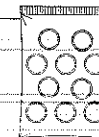

RP22132
Helpful Hand Installation Aid
Utensilio para Asistencia en Instalaciones a Mano

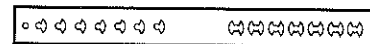

RP3614
Repair Kit
Herramientas para Reparaciones



RP1974
Wrench-Handle/Adjusting Ring
Llave-Manija/Anillo de Ajuste

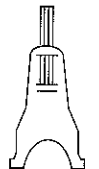

RP20587
Bonnet Removal Wrench-
(RP50 w/Knurls)
Llave para Sacar Capuchones-
(RP50 con Estrias)

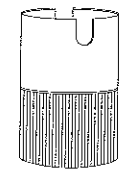

RP23489
Plumbers Hook - Seat,
Spring & Spout O-Ring
Removal Tool
Gancho de Plomero-
Asiento, Resorte y Herr.
para Sacar Anillo "O" del
Tubo de Salida

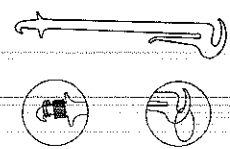

RP2932
Boxed Assortment
Maintenance Parts Kit
Piezas Surtidas de
Mantenimiento en Caja

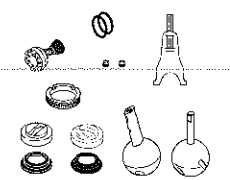

RP1740
Stem Unit Assy.- 2H-SS Plate
Ensamble Unidad-Espiga,
2H-Placa de Acero Inoxidable

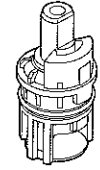

RP20111
Conversion Ball-Stainless Steel
(Changes Knob to Lever Handle)
(Cannot install lever handle limit
stop kit after this conversion)
Bola de Conversión-Acero
Inoxidable (Cambia de Perilla a
Manija de Palanca) (No se pueden
instalar las herramientas para el
tope del límite, de palanca, después
de hacer esta conversión)

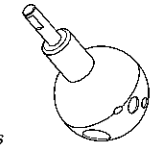

RP16423
Reverse Ball-Stainless Steel
(Corrects Reverse Supply Lines)
Bola de Inversión-Acero
Inoxidable (Corrige las Líneas
de Contraluz)

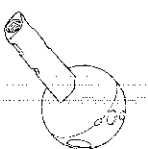

RP8230
Ceramic Stem Unit, Seat,
O-Ring, Spring & Screw
Unidad del Vástago de Cerámica,
Asiento, Anillo "O", Resorte y Tornillo

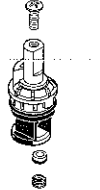

RP40307
Quick Connect
Spout Hose-67"
Manguera de
Conexión Rápida-67"

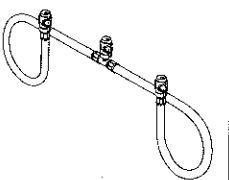

RP25513
Stem Unit Assembly-Brass Stem-
SS Plate with 1/4 Turn Stop
Ensamble de la Unidad del Vástago-
Vástago Bronce-Placa de Acero
Inoxidable con Tope a un 1/4 de Giración

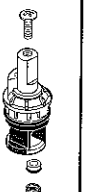

Lift Rods Barra de Alzar

Lift Rods Barra de Alzar

For Models/Modelos 520, 550, 2520, 2530, 3520, 3530 & 3540 Series

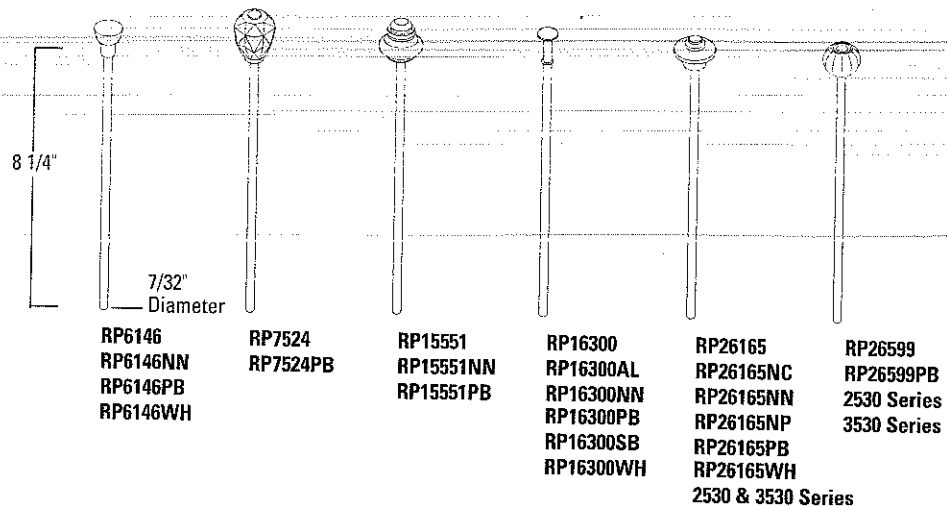

For Models/Modelos 2560*, 2565, 2580 & 2585 Series

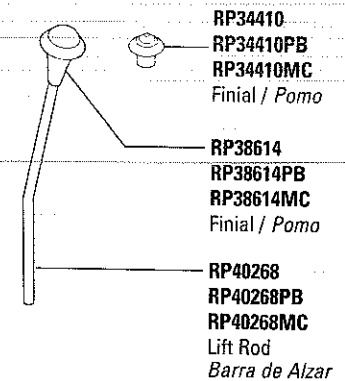

For Models/Modelos 2577, 2583, 3567, 4530 & 4577 Series

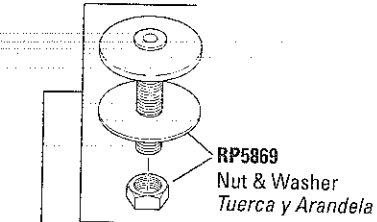
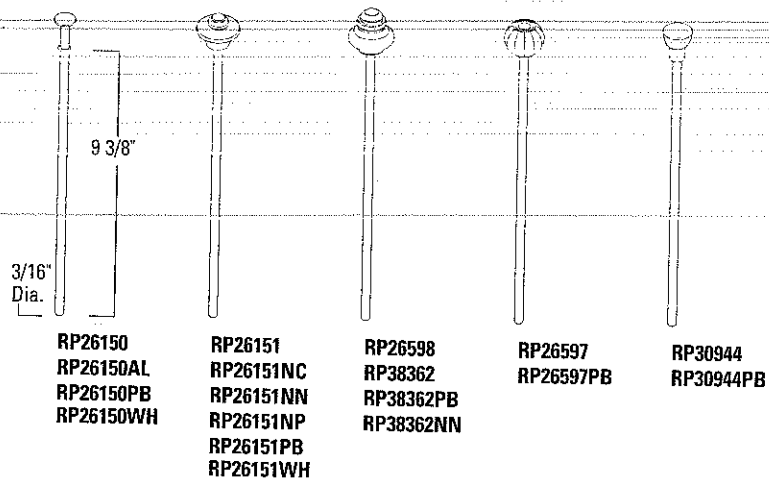

LIFT RODS

LIFT RODS

For Model/Modelo 540 Series

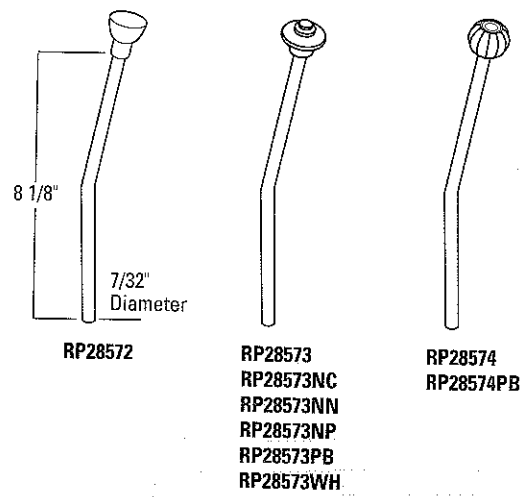

For Model/Modelo 547 Series



For Model/Modelo 2567 Series

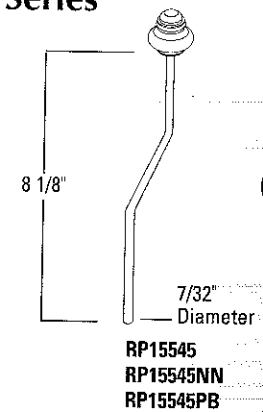

For Model/Modelo 2588 Series

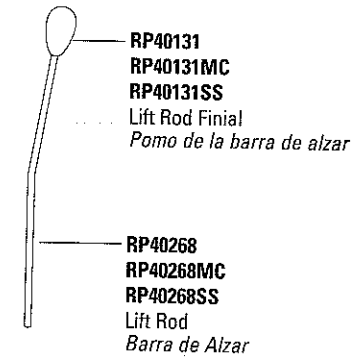

For Models/Modelos 2555, 3555 & 4555 Series

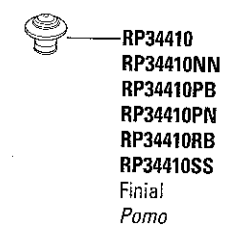

Lift Rod is not removable.
La barra de alzar no es removible.

For Models/Modelos 3560* & 3565 Series

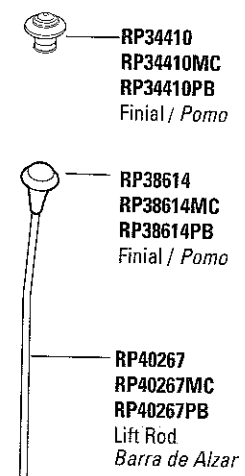

For Models/Modelos 3577, 3583 & 3584 Series

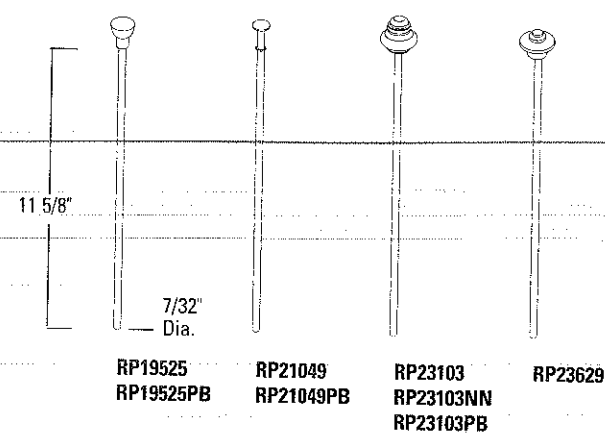

For Models/Modelos 3588 & 4588 Series

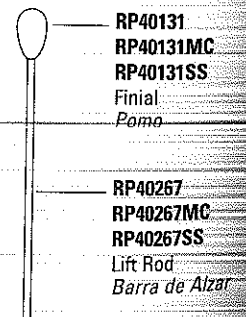

Refer to pages 100-101 for lavatory drain assemblies. / Para ensamble de drenaje para lavamanos refierase a las paginas 100-101.

Refer to pages 100-101 for lavatory drain assemblies. / Para ensambles de drenaje para lavamanos refierase a las paginas 100-101.

Lavatory Drain Assemblies

Ensamblajes para Desagües Automáticos para Lavamanos

Lavatory Drain Assemblies

Ensamblajes para Desagües Automáticos para Lavamanos

RP5651▲ Complete Metal Pop-Up Assembly
Ensamble de Metal del Desagüe Automático
RP26533▲ Metal Pop-Up Assembly (Less Lift Rod)
Ensamble de Desagüe Automático de Metal (Sin Barra de Alzar)

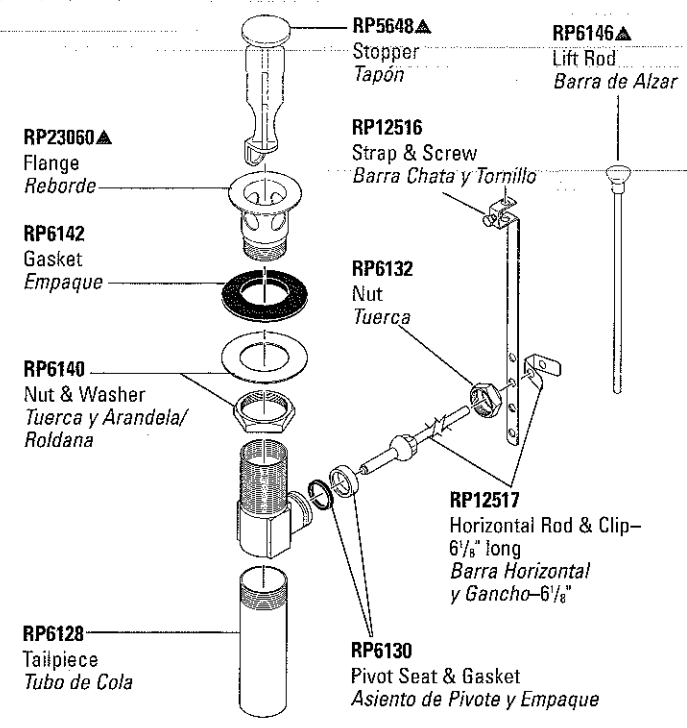

RP27575 Complete 50/50 Pop-Up Assembly / *Ensamble Completo para Desagüe Automático en 50/50*
RP38958 50/50 Pop-Up Assembly Less Lift Rod / *Ensamble del Desagüe Automático Sin la Barra Para Alzarlo*

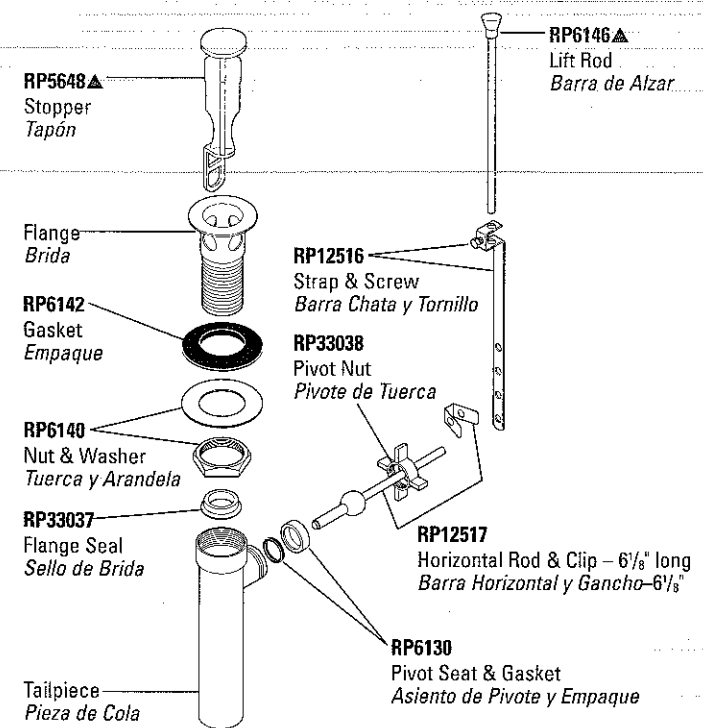

RP6463 Complete Snap-N-Pop-Up® Assembly
Ensamble Completo del Desagüe Automático Snap-N-Pop-Up®

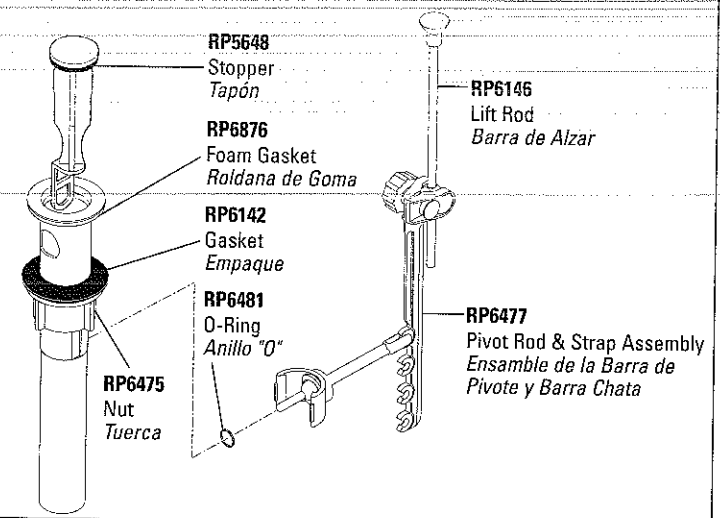

Accessory Items
Piezas de Accesorios

RP7585 Extender for Pivot Rod
Pieza de Extensión para Ensamble de la Barra de Pivote

RP10994 Spacer for thin sinks (fits between RP6142 & RP6475)
Separador para Lavamanos Delgados (para RP6142 y RP6475)

Alternate "N" Model Metal Pop-Up Assembly Parts*
 (Not Available as Complete Pop-Up RP)
Piezas alternas para el modelo "N" de Metal del desagüe automático (no son disponibles como un juego de piezas de repuesto completo para el desagüe automático)*

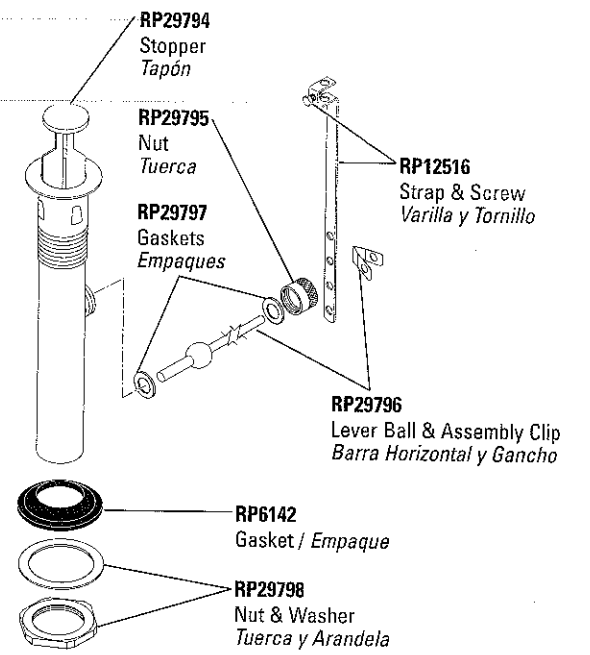

RP6346▲ Complete Metal Grid Strainer Assembly
Ensamble Completo del Colador con Rejilla de Metal

Manufactured Before June 1996 - Some components may not be available.
Fabricado Antes de Junio 1996 - Algunos componentes pueden no estar disponibles.

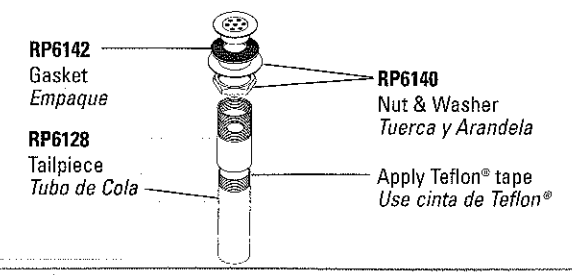

Manufactured After June 1996
Fabricado Después de Junio 1996

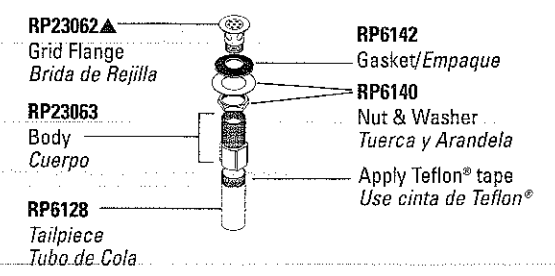

Longer Horizontal Rods for Pop-up Assemblies
Barras horizontales más largas para los ensambles de desagües

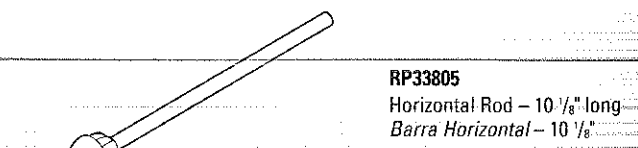

33T290 (w/overflow holes/con huecos para desbordes)
33T290-1 (no overflow holes/sin huecos para desbordes)
 Complete Cast Brass Offset Grid Strainer
Colador acodado de rejilla de bronce fundido completo

CAMBRIDGE BRASS, USA

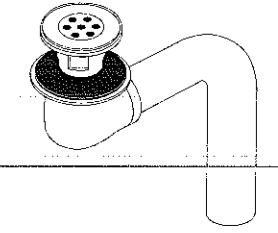

Single Handle Bath Valves

Válvulas de Una Manija (Maneral) para Bañeras

Single Handle Monitor® Bath Valves

Válvulas de Bañeras Monitor® de Manija Sencilla

Classic Series Models/Modelos 601, 602, 606*, 611*, 612, 621, 622, 635, 636, 641 & 642 Series

Monitor® Series Models/Modelos 1300 & 1400 Series

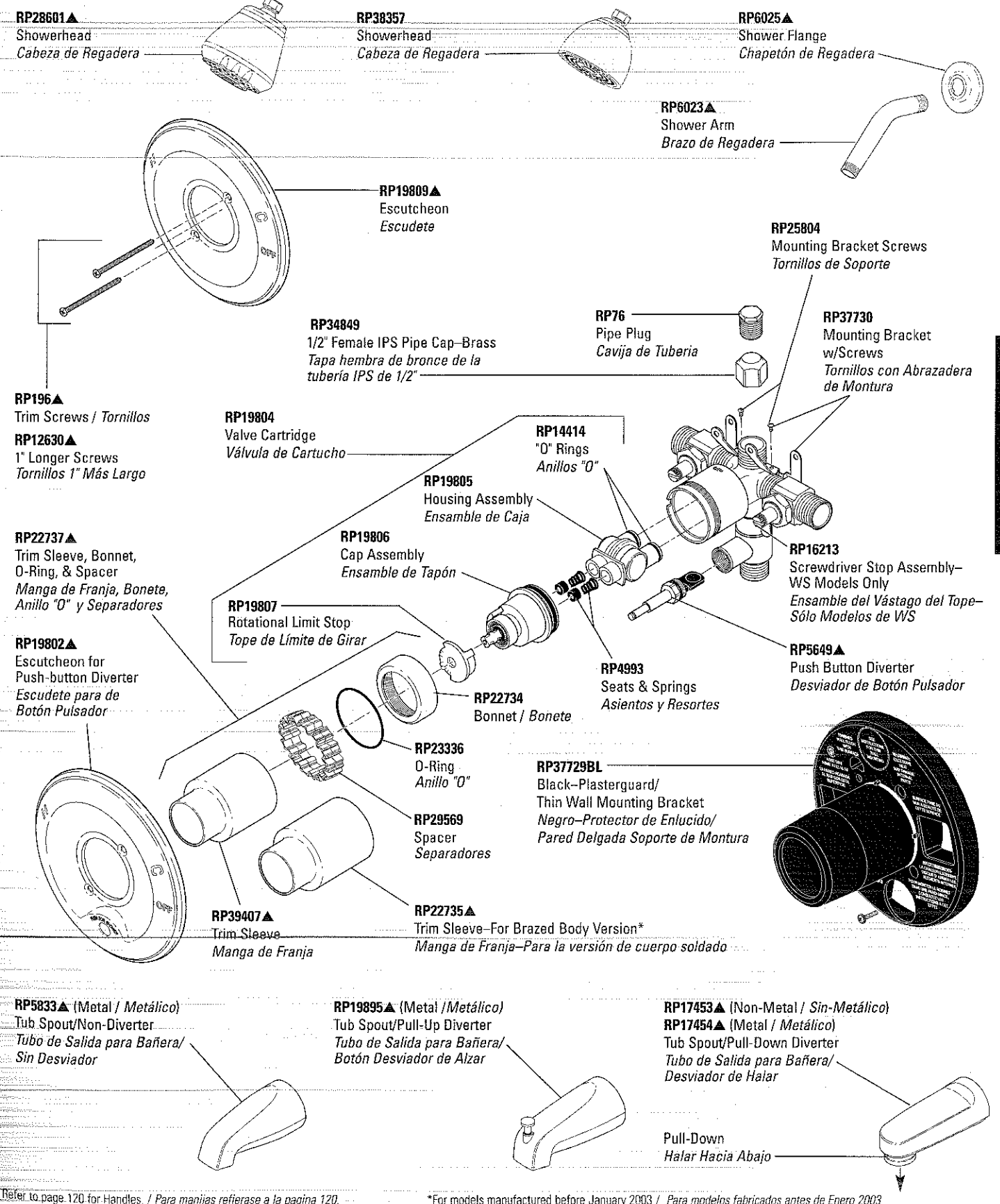
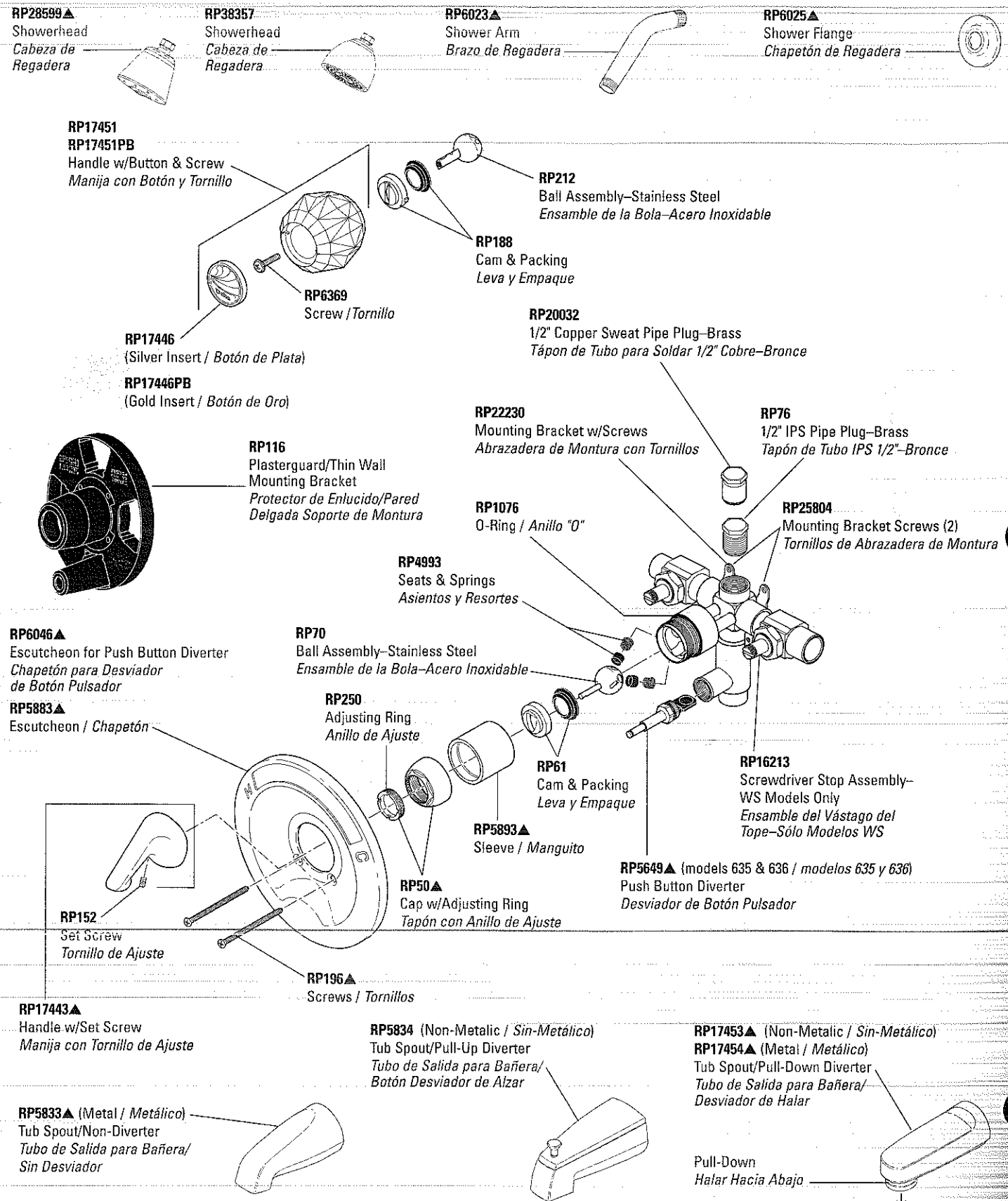

TUB/SHOWER

TUB/SHOWER

Single Handle Monitor® Bath Valves Válvulas de Bañeras Monitor® de Manija Sencilla

Victorian™ Collection Models/Modelos 1425 & 1455 Series

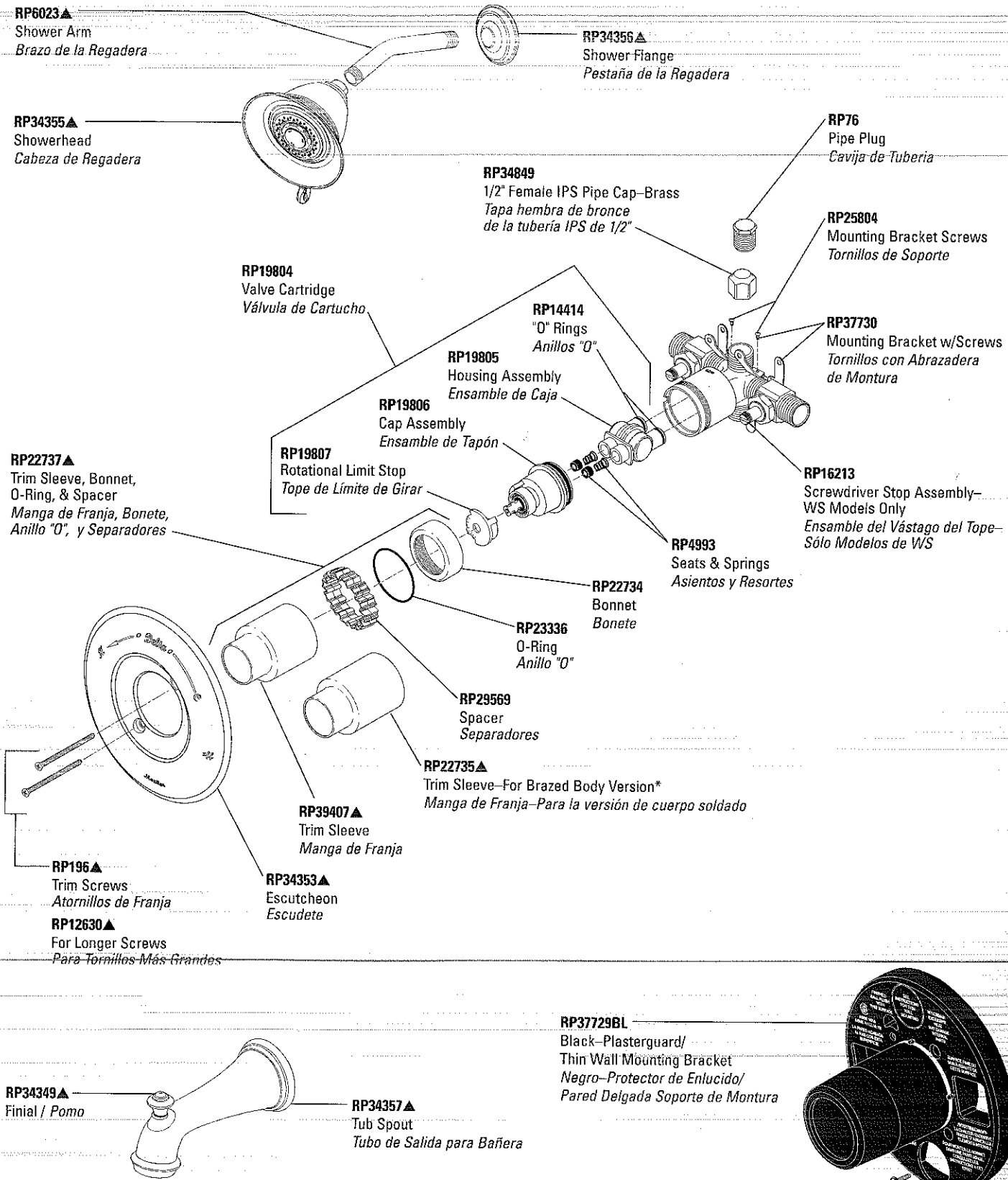

Refer to page 120 for Handles. / Para manijas referirse a la pagina 120.

*For models manufactured before January 2003 / Para modelos fabricados antes de Enero 2003

Single Handle Monitor® Bath Valves Válvulas de Bañeras Monitor® de Manija Sencilla

e-Flow® Series Models/Modelos 1427 & 1447 Series

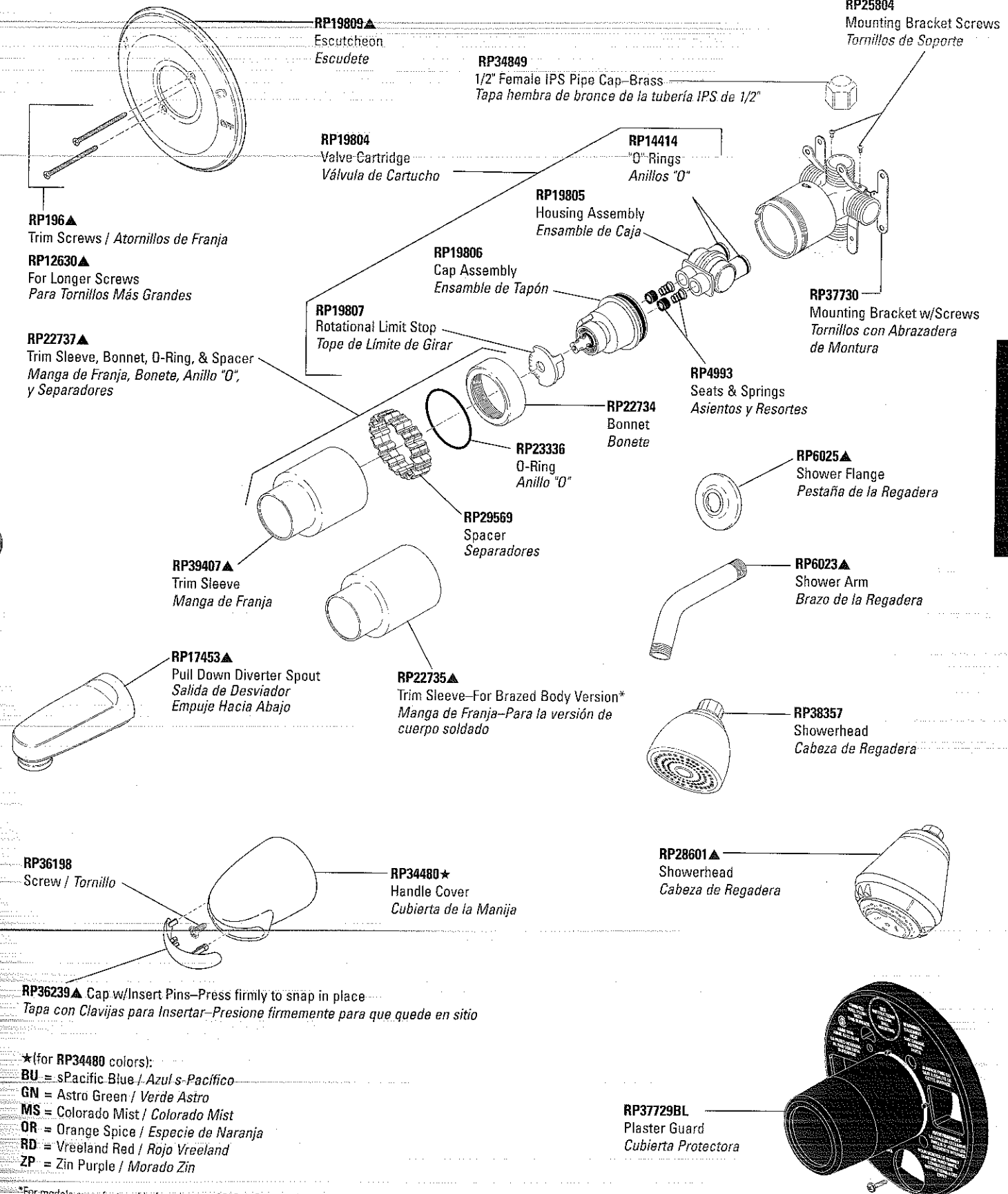

RP36239 Cap w/Insert Pins-Press firmly to snap in place
Tapa con Clavijas para Insertar-Presione firmemente para que quede en sitio

*for RP34480 colors:
BU = sPacific Blue / Azul s-Pacífico
GN = Astro Green / Verde Astro
MS = Colorado Mist / Colorado Mist
OR = Orange Spice / Especie de Naranja
RD = Vreeland Red / Rojo Vreeland
ZP = Zin Purple / Morado Zin

*For models manufactured before January 2003 / Para modelos fabricados antes de Enero 2003

RP37729BL
Plaster Guard
Cubierta Protectora

TUB/SHOWER

TUB/SHOWER

Single Handle Monitor® Bath Valves Válvulas de Bañeras Monitor® de Manija Sencilla

Botanical™ Series Models/Modelos 1430, 1460 & 1480 Series

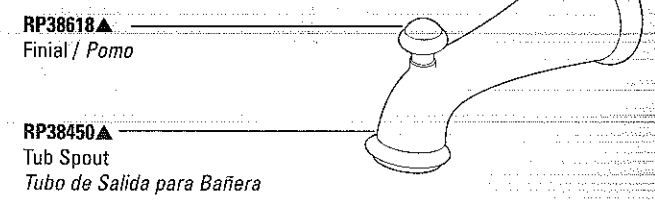
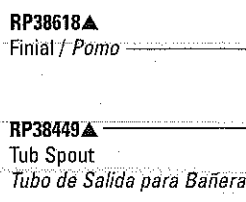
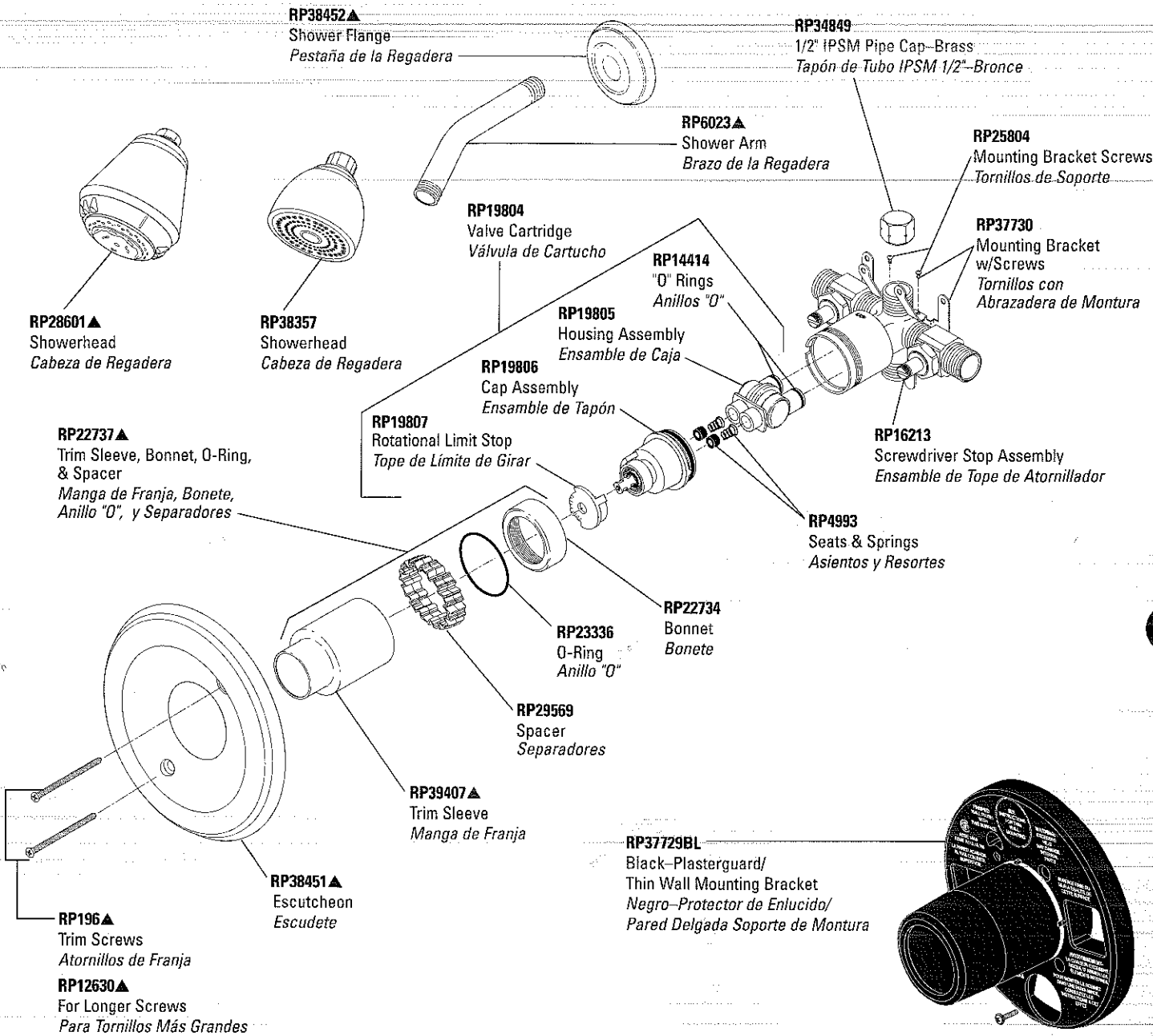

Single Handle Monitor® Bath Valves Válvulas de Bañeras Monitor® de Manija Sencilla

Monitor® Series Models/Modelos 1500* Series

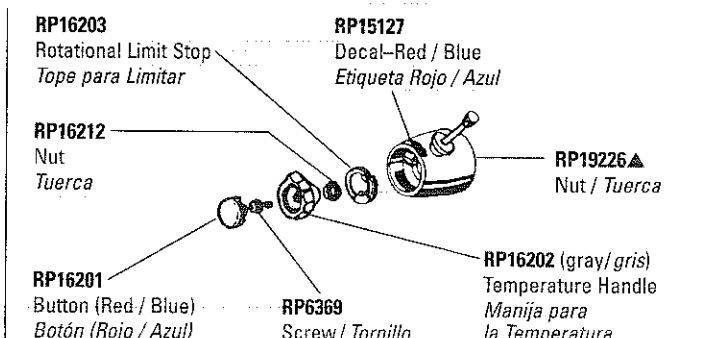
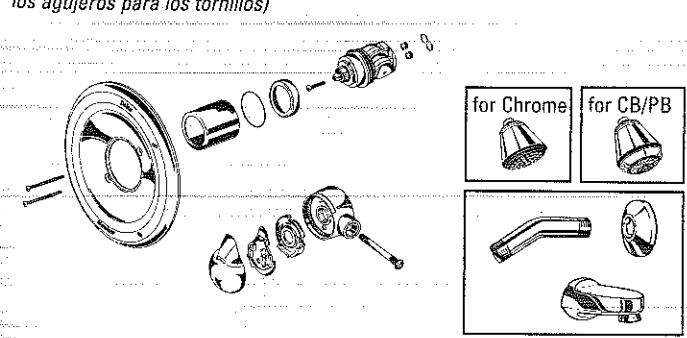
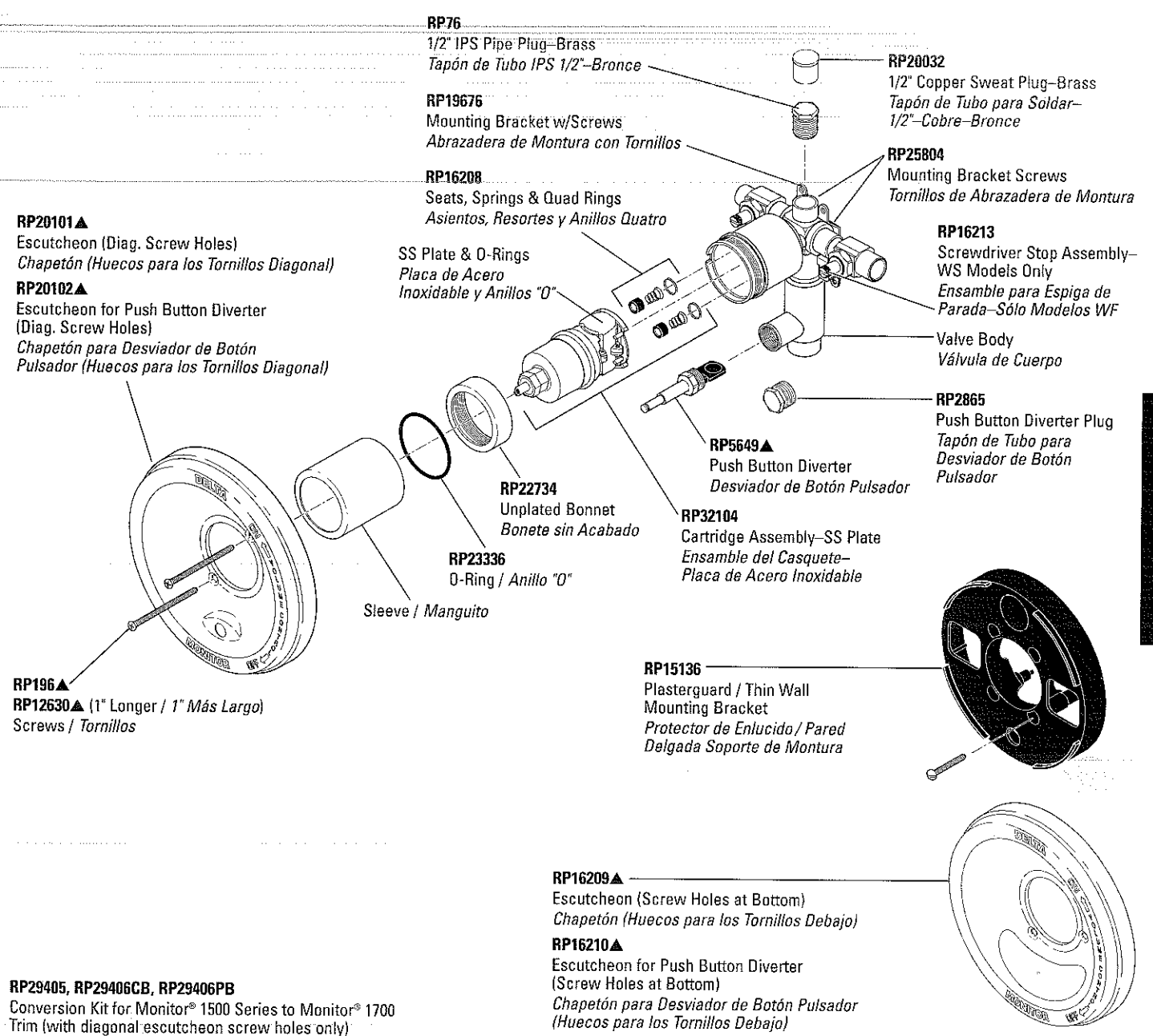

Refer to page 120 for Handles. / Para manijas referirse a la pagina 120.

Refer to pages 120 for handle accents. / Para accents del manijas referirse a la pagina 120.

Single Handle Bath Valves Válvulas de Una Manija (Maneral) para Bañeras

Classic Series Model/Modelo 1600* Series

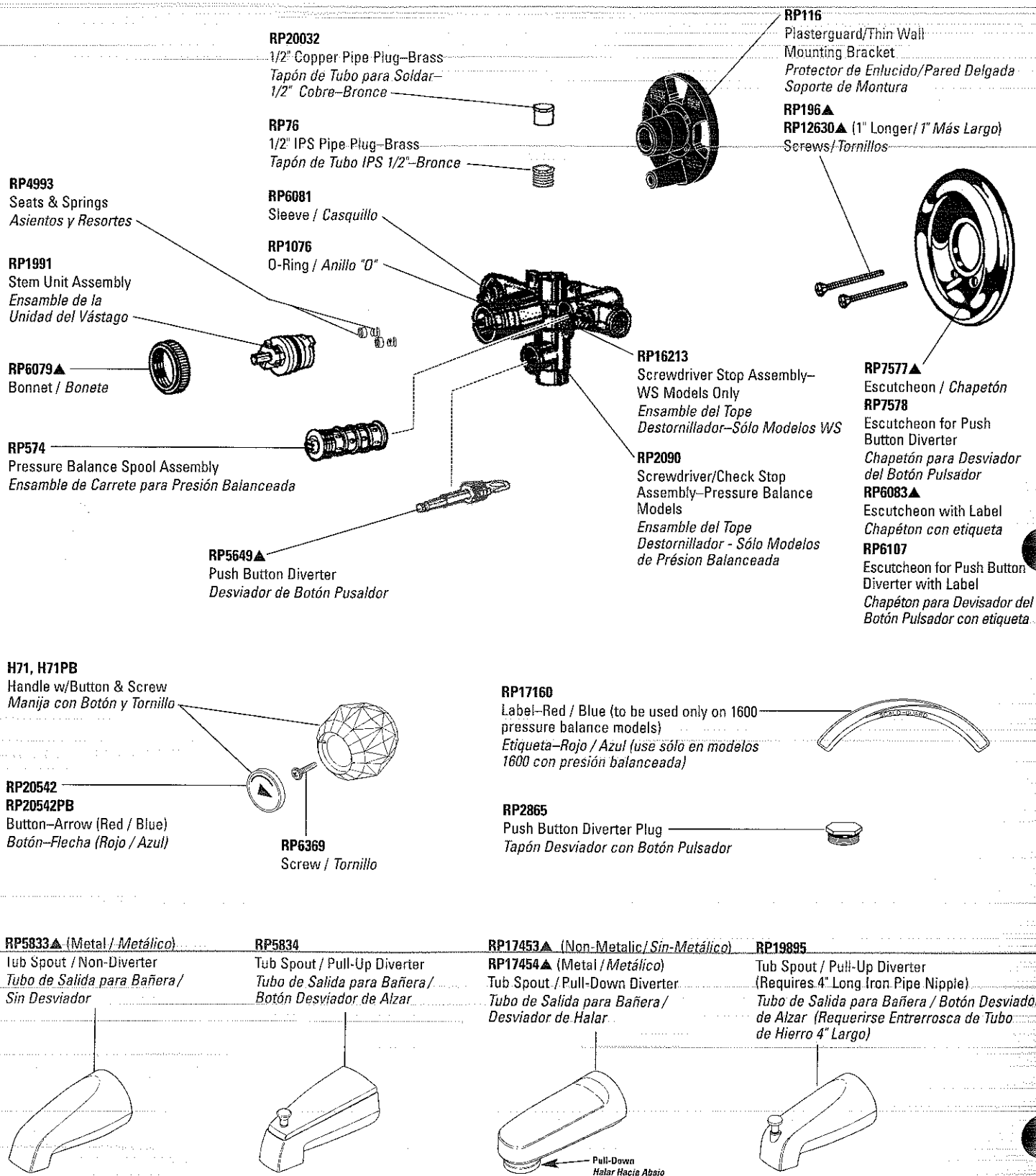

Single Handle Monitor® Bath Valves Válvulas de Bañeras Monitor® de Manija Sencilla

Monitor® Series Model/Modelo 1700 Series

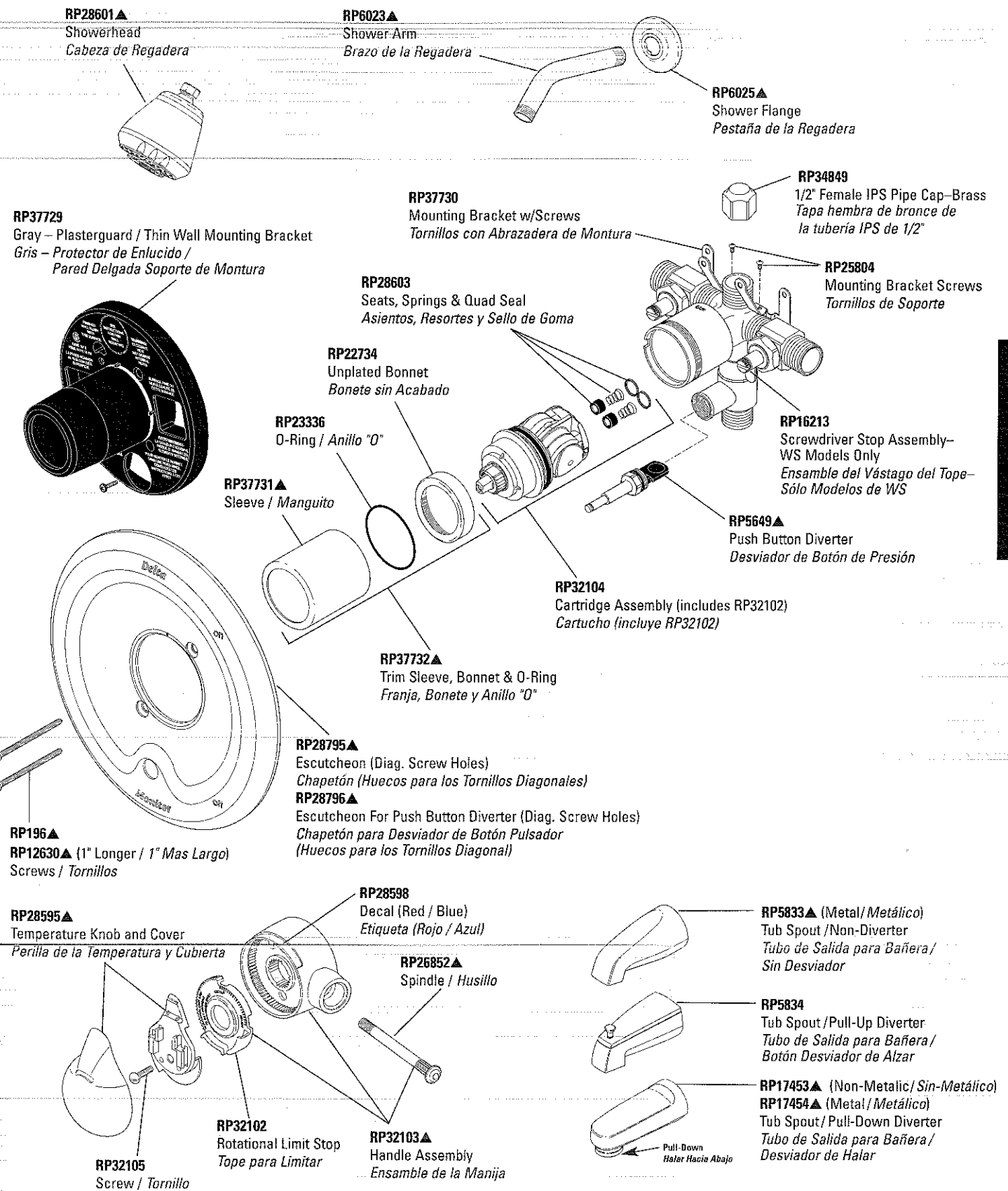

Refer to pages 120 for handle accents. / Para accents del manijas referirse a la pagina 120.

Single Handle Monitor® Bath Valves

Válvulas de Bañeras Monitor® de Manija Sencilla

Victorian™ Collection Models/Modelos 1725 & 1755 Series

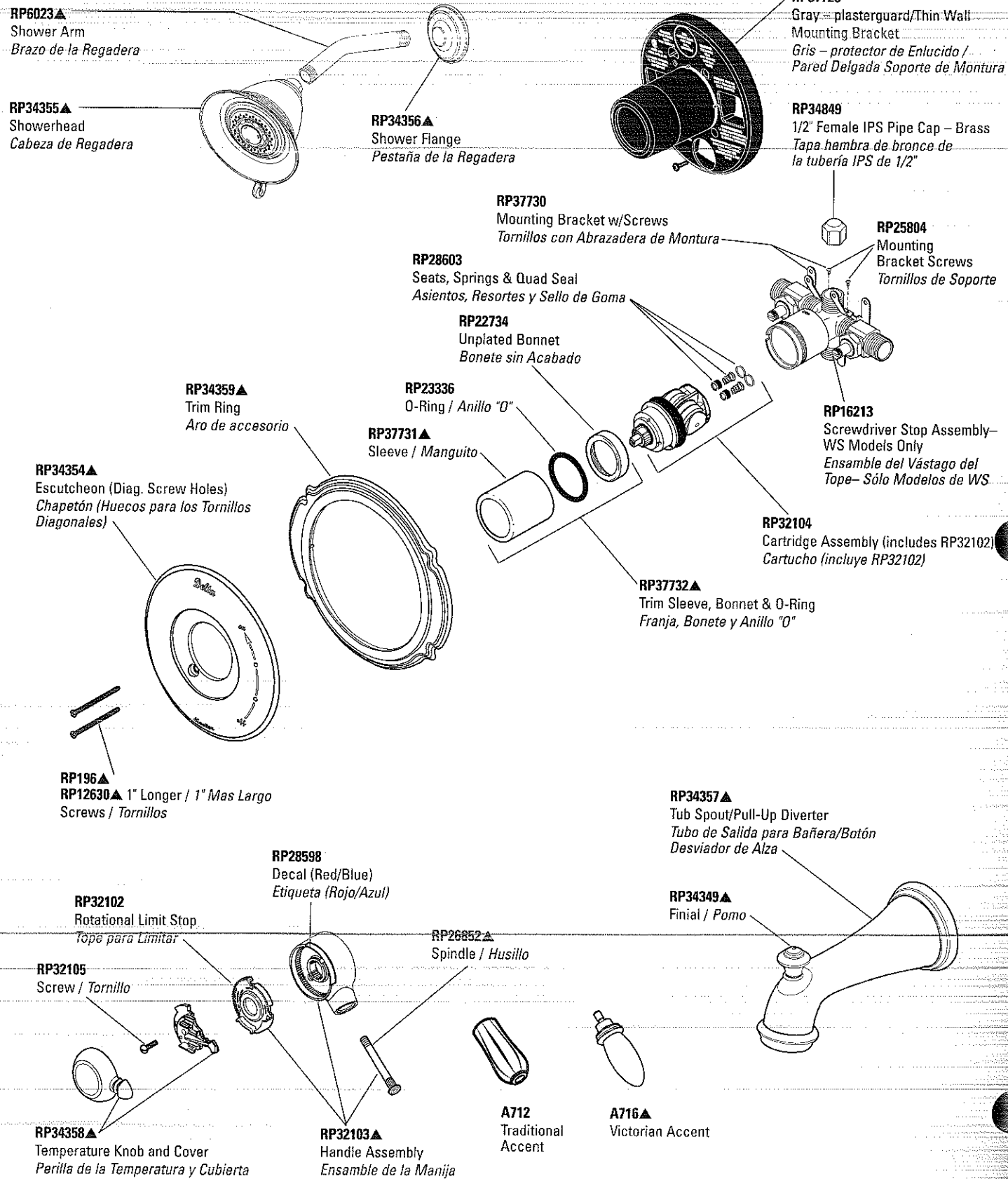

Single Handle Monitor® Bath Valves

Válvulas de Bañeras Monitor® de Manija Sencilla

MICHAEL GRAVES COLLECTION Models/Modelos 1728, 1768 & 1769 Series

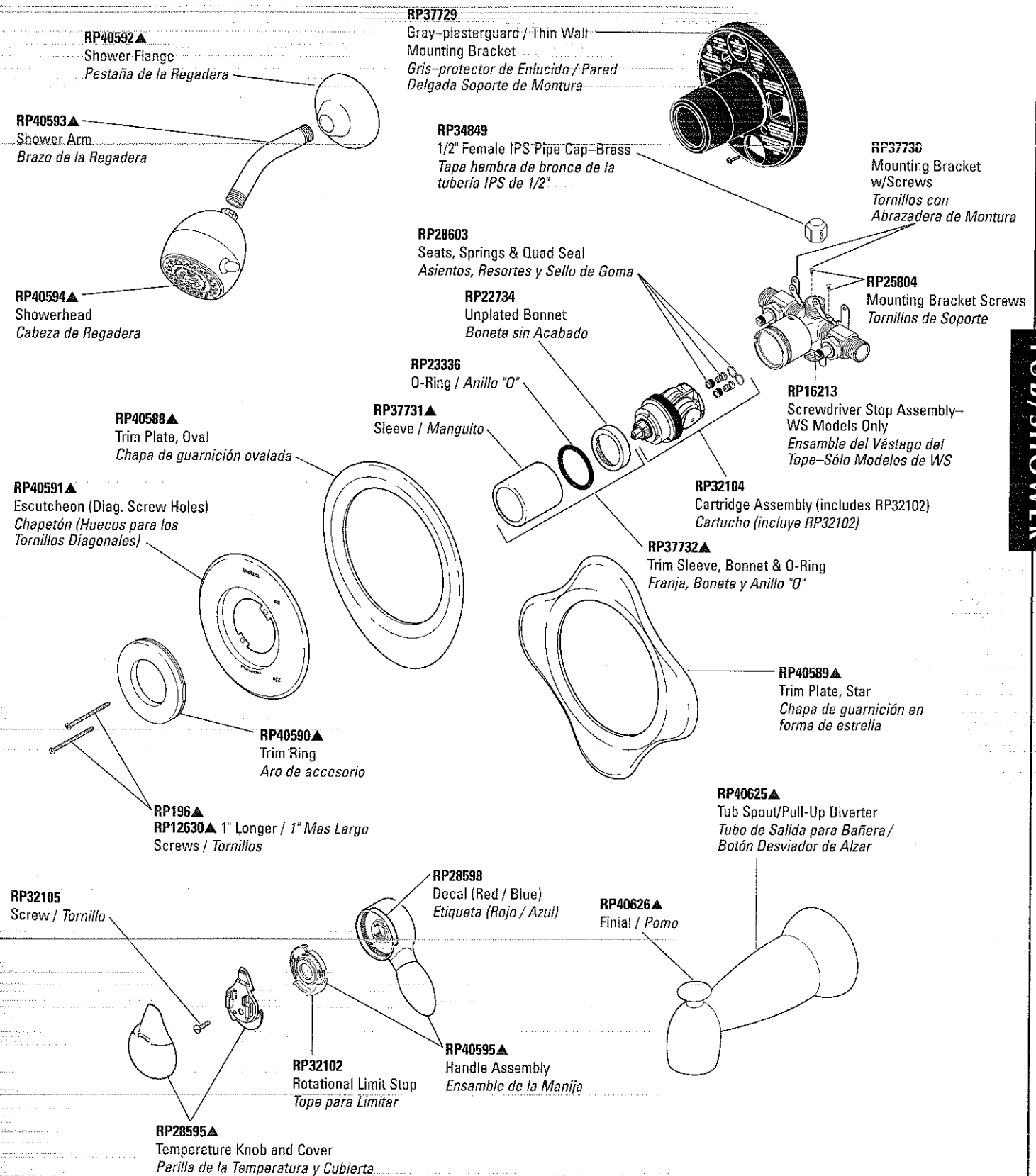

Single Handle Monitor Bath Valves

Válvulas de Una Manija (Maneral) para Bañeras

Monitor 1800 Jetted Shower™ Systems—Trim only
 Innovations® Series Models T1824
 Victorian™ Collection Models T1825

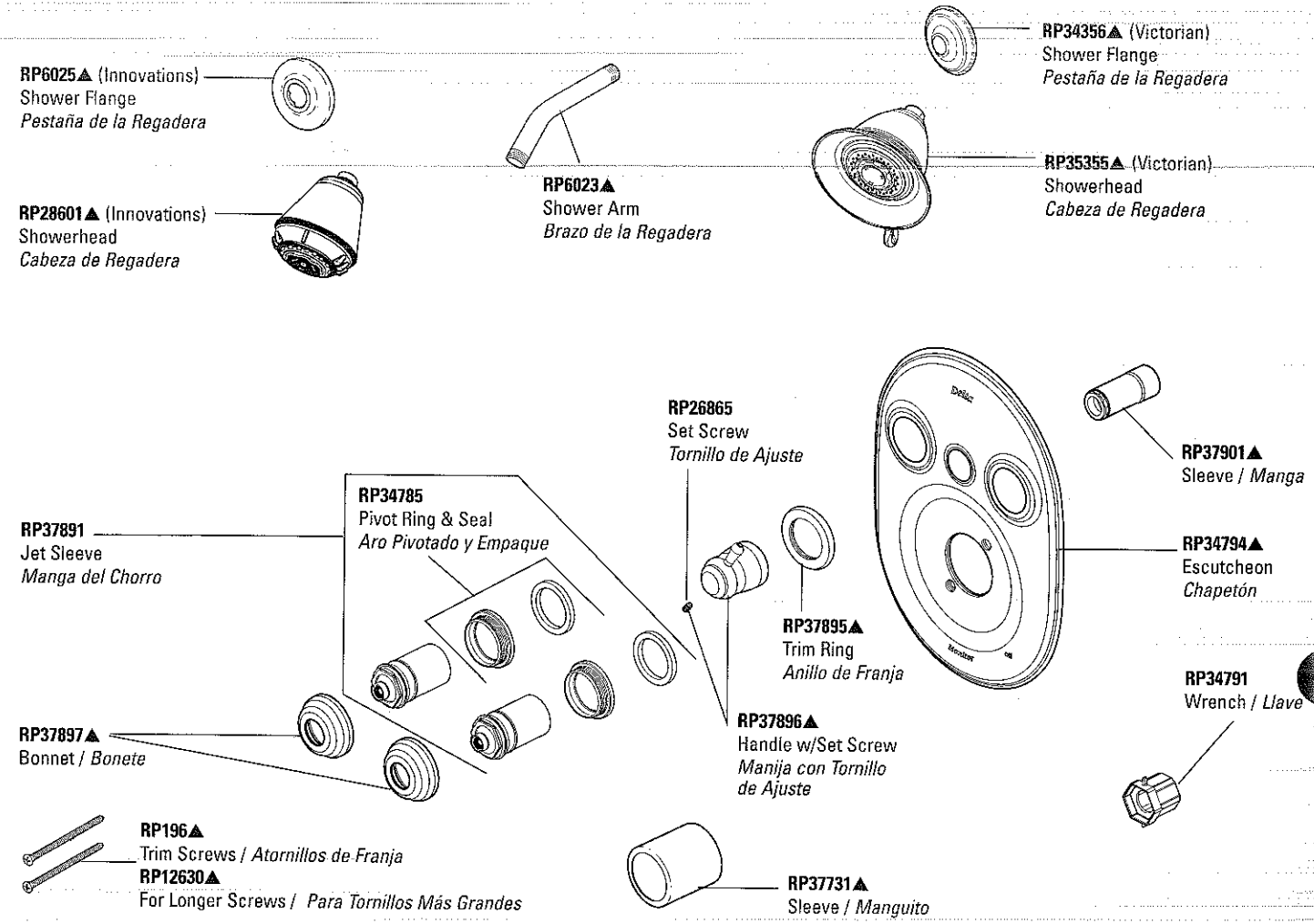

Innovations® Series

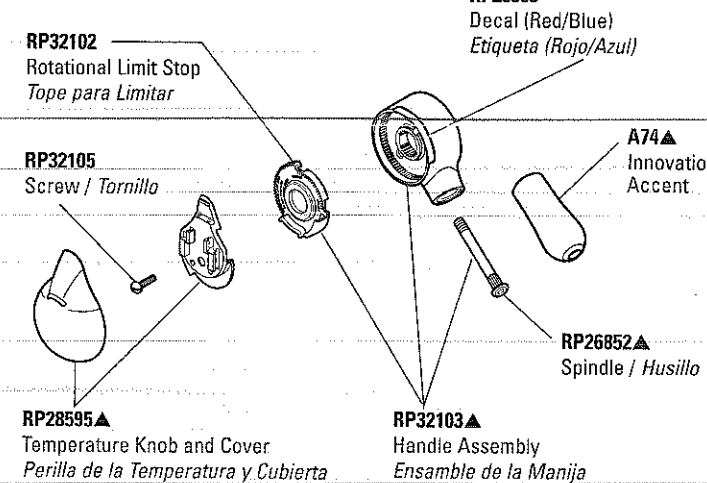

Victorian™ Collection

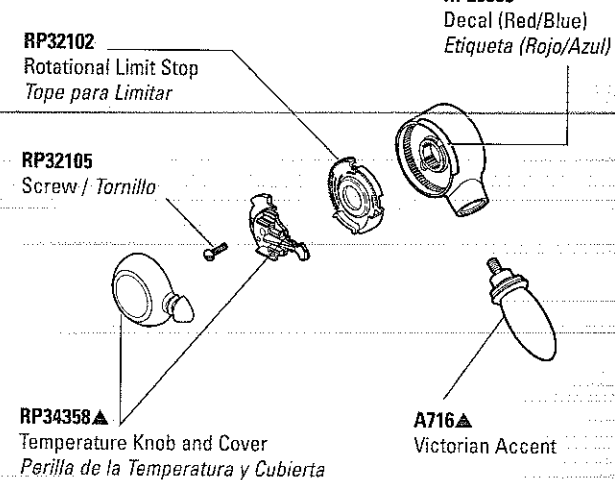

Single Handle Monitor Bath Valves

Válvulas de Una Manija (Maneral) para Bañeras

Monitor 1800 Jetted Tub/Shower™ Systems—Trim only
 Innovations® Series Models T1848
 Victorian™ Collection Models T1855

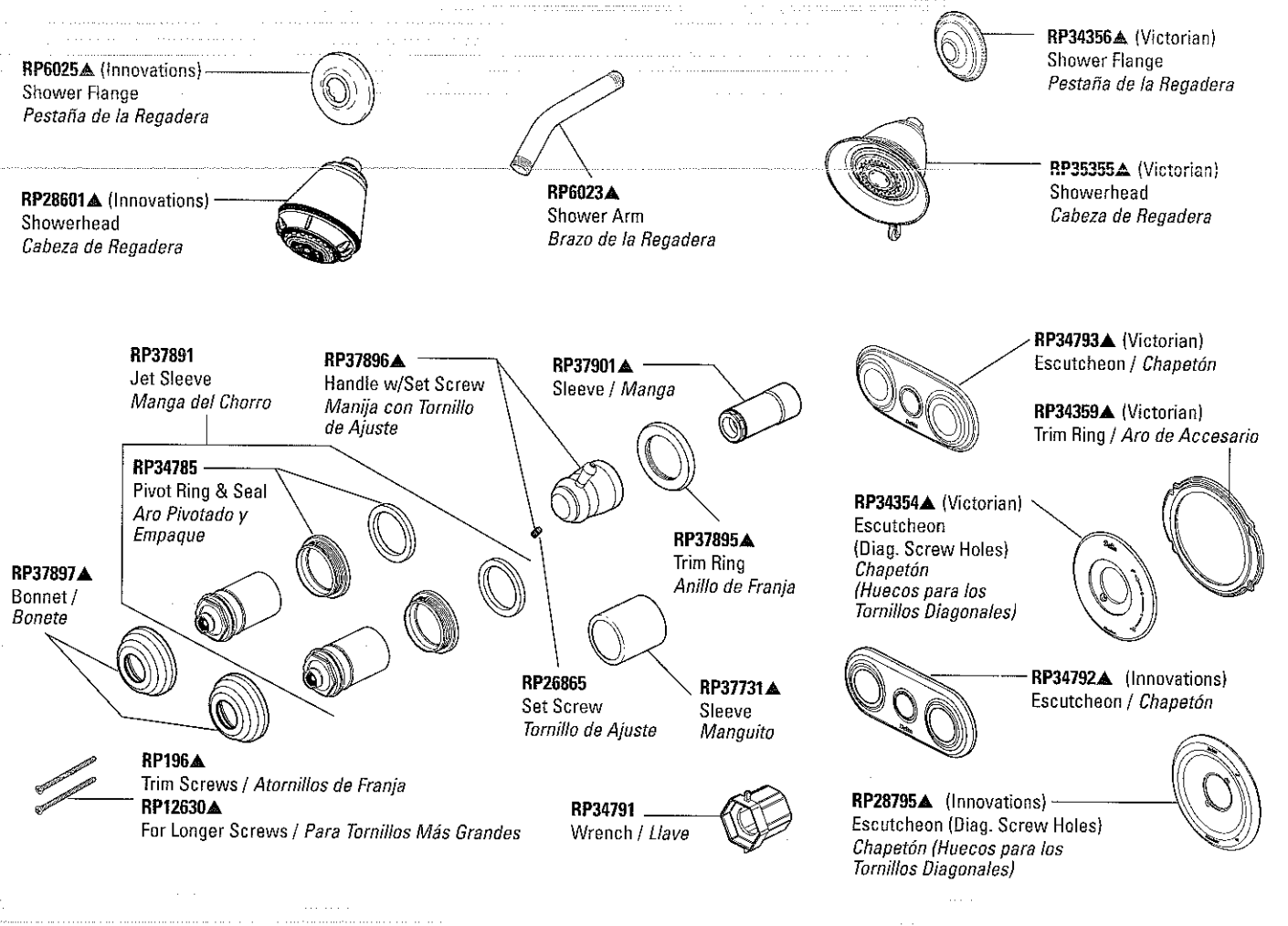

Innovations® Series

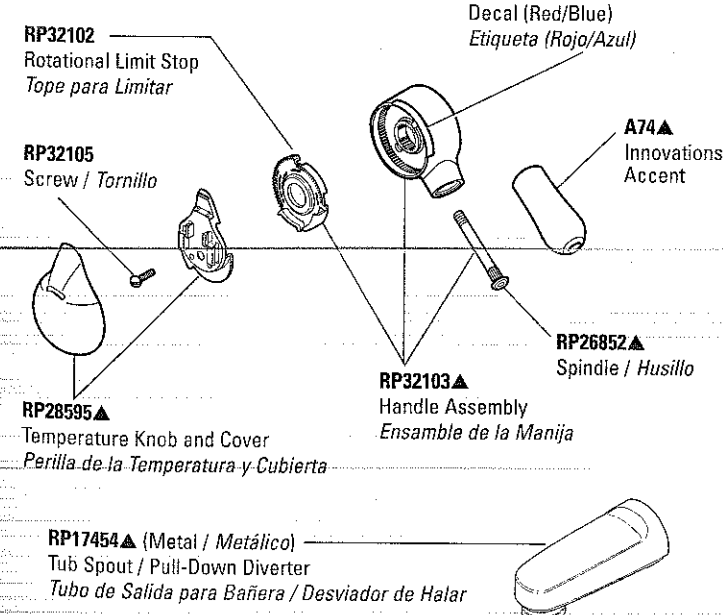

Victorian™ Collection

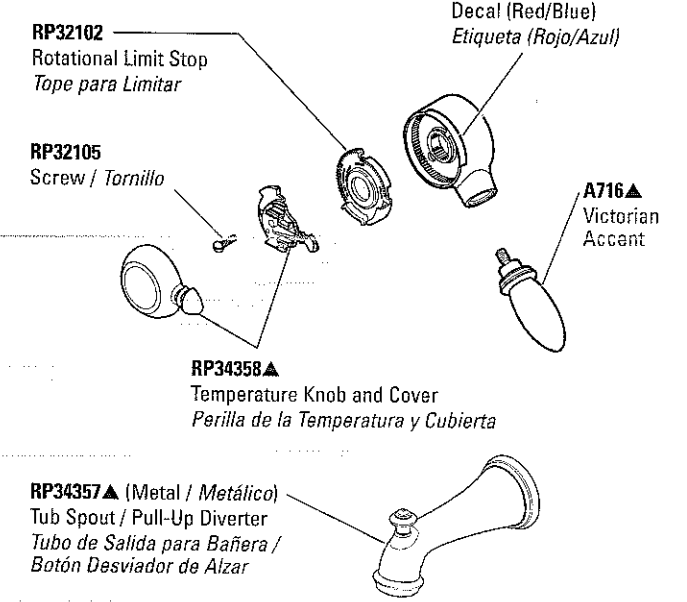

TUB/SHOWER

TUB/SHOWER

Single Handle Monitor Bath Valves

Válvulas de Una Manija (Maneral) para Bañeras

Single Handle Monitor Bath Valves

Válvulas de Una Manija (Maneral) para Bañeras

Monitor 1800 Jetted Shower XO™—Rough Only
R1822—Shower Only
R1842—Tub/Shower

Monitor 1800 Jetted Shower™—Rough Only
R1824—Shower Only
R1848—Tub/Shower

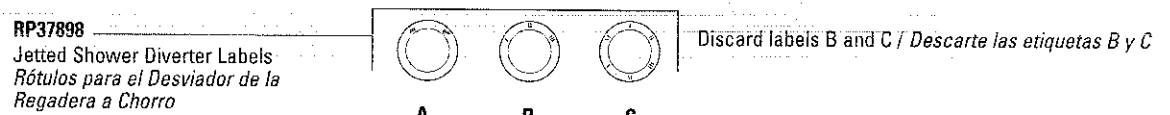
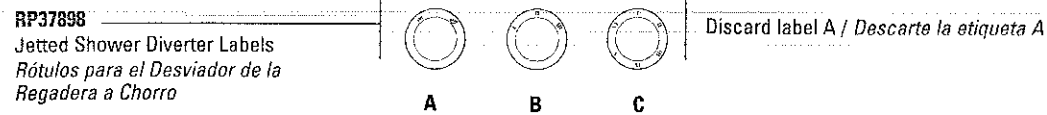

Apply label B to trim ring RP37895 if Jetted Shower XO™ is 3 function.
 Apply label C to trim ring RP37895 if Jetted Shower XO™ is 6 function.
 Si instala Función 3 de Jetted Shower XO™, aplique la Etiqueta B para el Funcionamiento, a la pieza RP37898.
 Si instala Función 6 de Jetted Shower XO™, aplique la Etiqueta C para el Funcionamiento, a la pieza RP37898.

Apply label A to trim ring RP37895 if Jetted Shower™ valve is installed.
 Si instala una válvula de Jetted Shower™, aplique la Etiqueta A para el Funcionamiento, a la pieza RP37895.

Description:
 Jetted Shower XO™ valves divert the water to the jets ①, the showerhead ②, an extra port ③ or any combination of two, making it a 3 port, 6 function diverter. The black stem extender ④ (without the stop) must be used. If a 2 port, 3 function diverter is desired, jets only, combination jets & showerhead and showerhead only, the plug ⑥ must be soldered in as shown and the blue stem extender ⑦ with the stop ⑤ must be used. Model included—1822.

Descripción:
 Las válvulas para las regaderas Jetted Shower XO™ desvían el agua a los chorros ①, la cabeza de la regadera ②, una toma adicional ③ o cualquier combinación de dos, haciendo este un desviador de seis funciones. Debe usar la extensión con la espiga negra ④ (sin el tope). Si desea un desviador de tres funciones, sólo chorros, combinación de chorros y regadera y regadera solamente, el tapón ⑥ debe soldarse como se muestra y sólo debe usar la espiga azul de extensión ⑦ con el tope ⑤. Se incluye el modelo 1822.

Description:
 Jetted Shower™ valves turn the body jets on and off only. The center shank of the jet module is 1 1/2" maximum. Models included—1848 and 1855 series.

Descripción:
 Las válvulas de agua para las regaderas Jetted Shower™ sólo abren y cierran el agua. La espiga central de la unidad de chorros es de un máximo de 1 1/2". Los modelos incluyen la serie 1848 y la 1855.

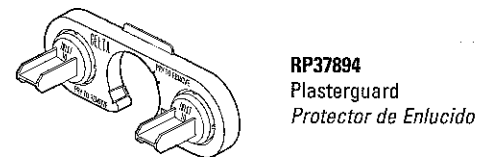
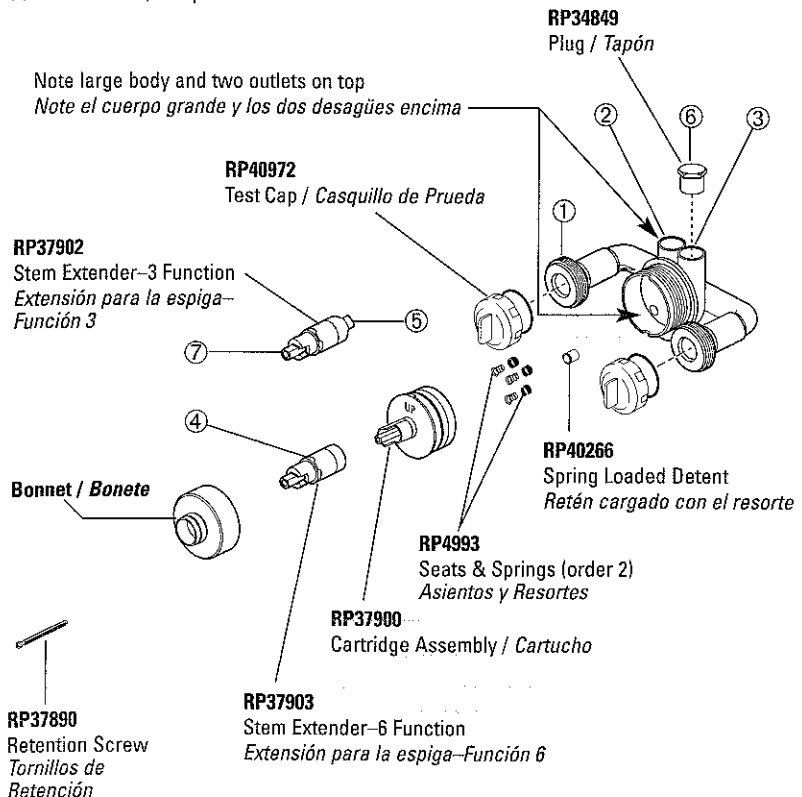

To remove plasterguard (RP37894), grasp outside edges and pull.
 Para quitar el protector de yeso (RP37894), agarre las orillas exteriores y hale.

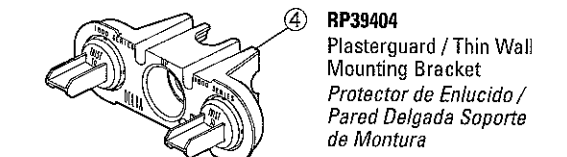
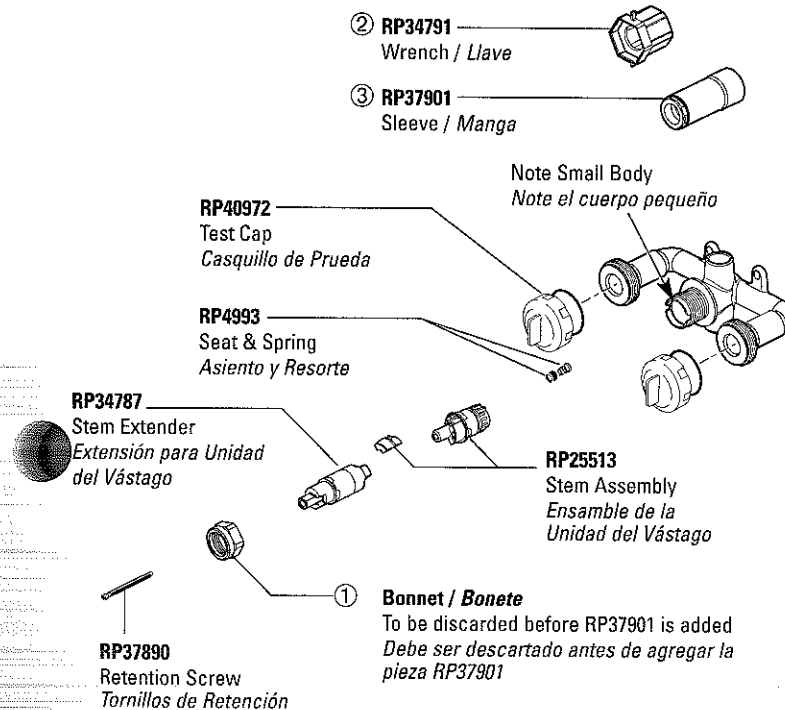
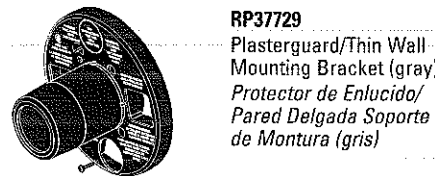

To remove plasterguard (RP39404), unthread bonnet ① using wrench (RP34791) ② or remove (RP37901) ③. Remove plasterguard ④. The bonnet may be discarded when the sleeve (RP37901) is used in its place. Tighten the sleeve (RP37901) securely.

Para quitar el protector de yeso (RP39404), desenrosque el capuchón ① usando la llave de tuercas (RP34791) ② o quite (RP37901) ③. Quite el protector de yeso ④. Cuando usa la manga (RP37901) en lugar del capuchón, puede descartar éste. Apriete bien fija la manga (RP37901).

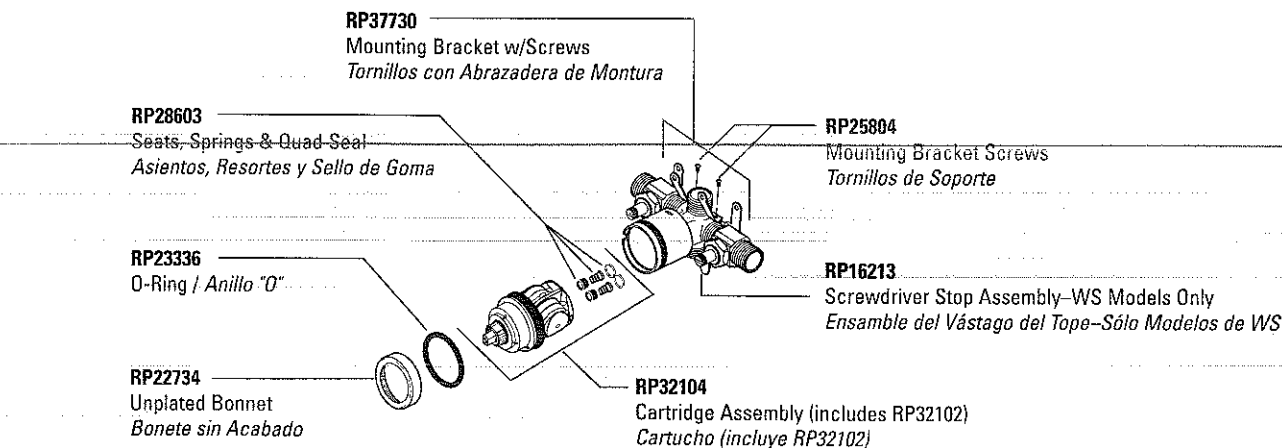

*R1822 ships with a non-removable silver-soldered plug in bottom outlet. / R1822 se envía con tapón fijo plateado soldado al desagüe en el fondo.

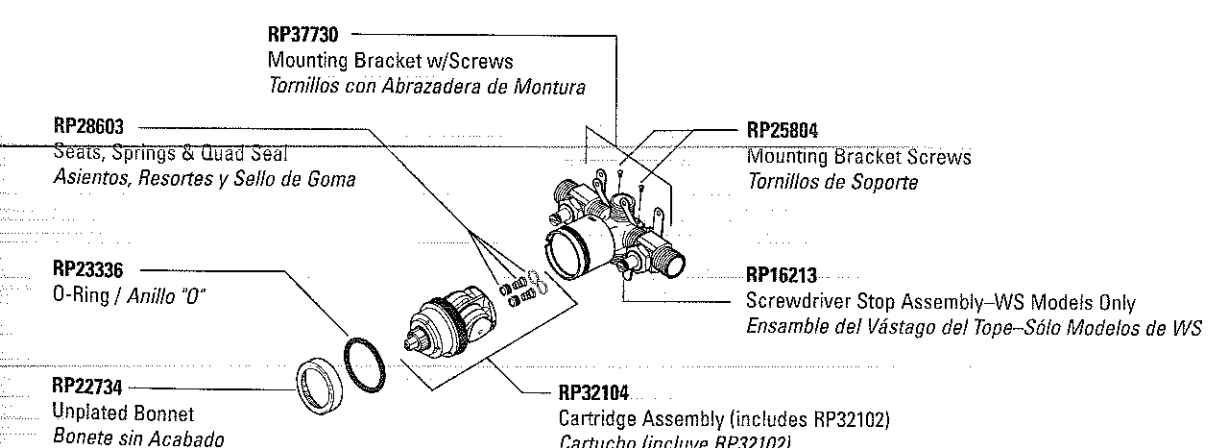

*R1824 ships with a non-removable silver-soldered plug in bottom outlet. / R1824 se envía con tapón fijo plateado soldado al desagüe en el fondo.

Single Handle Monitor Bath Valves

Válvulas de Una Manija (Maneral) para Bañeras

Monitor 1800 Jet Module XO™ Trim Only
 Innovations® Series T1817
 Victorian™ Collection T1837

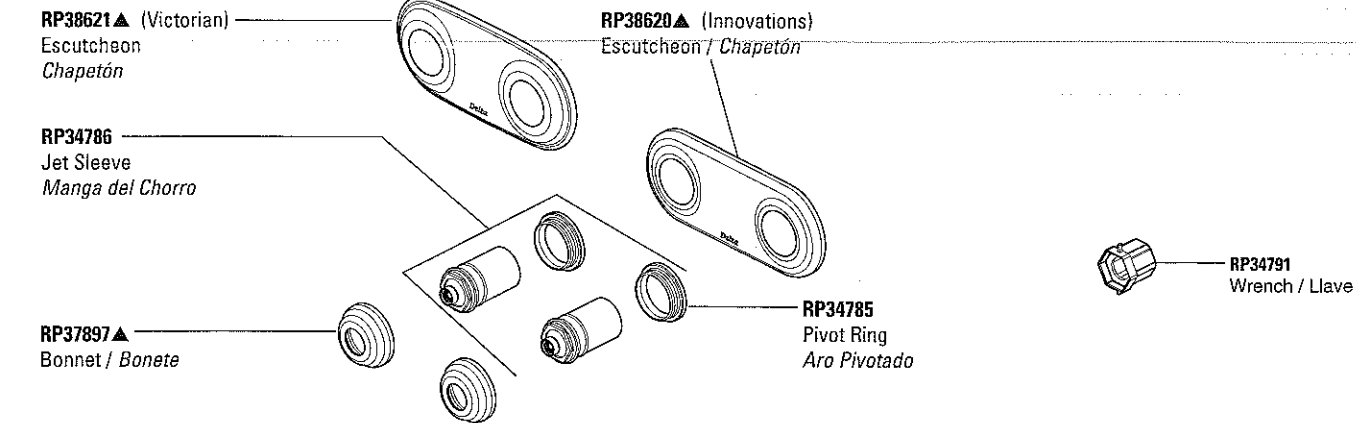

Monitor 1800 Jet Module XO™ Rough Only
 R1817

*For use as additional outlet with Model 1800 Series Jetted Shower XO.

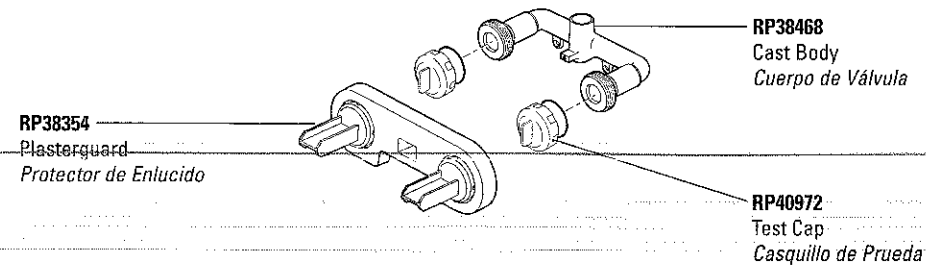

Two Handle Bath Valves

Válvulas de Dos Manijas para Bañeras

Classic Series Model/Modelo 2300* Series

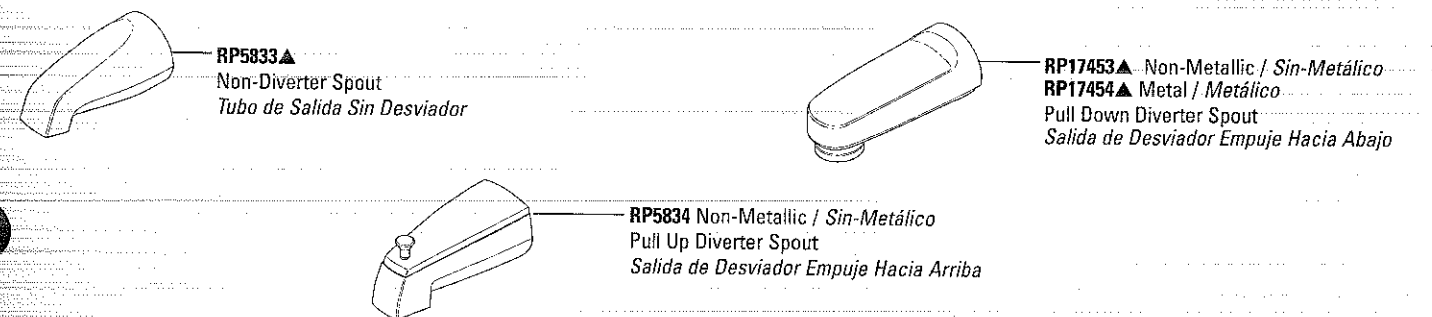
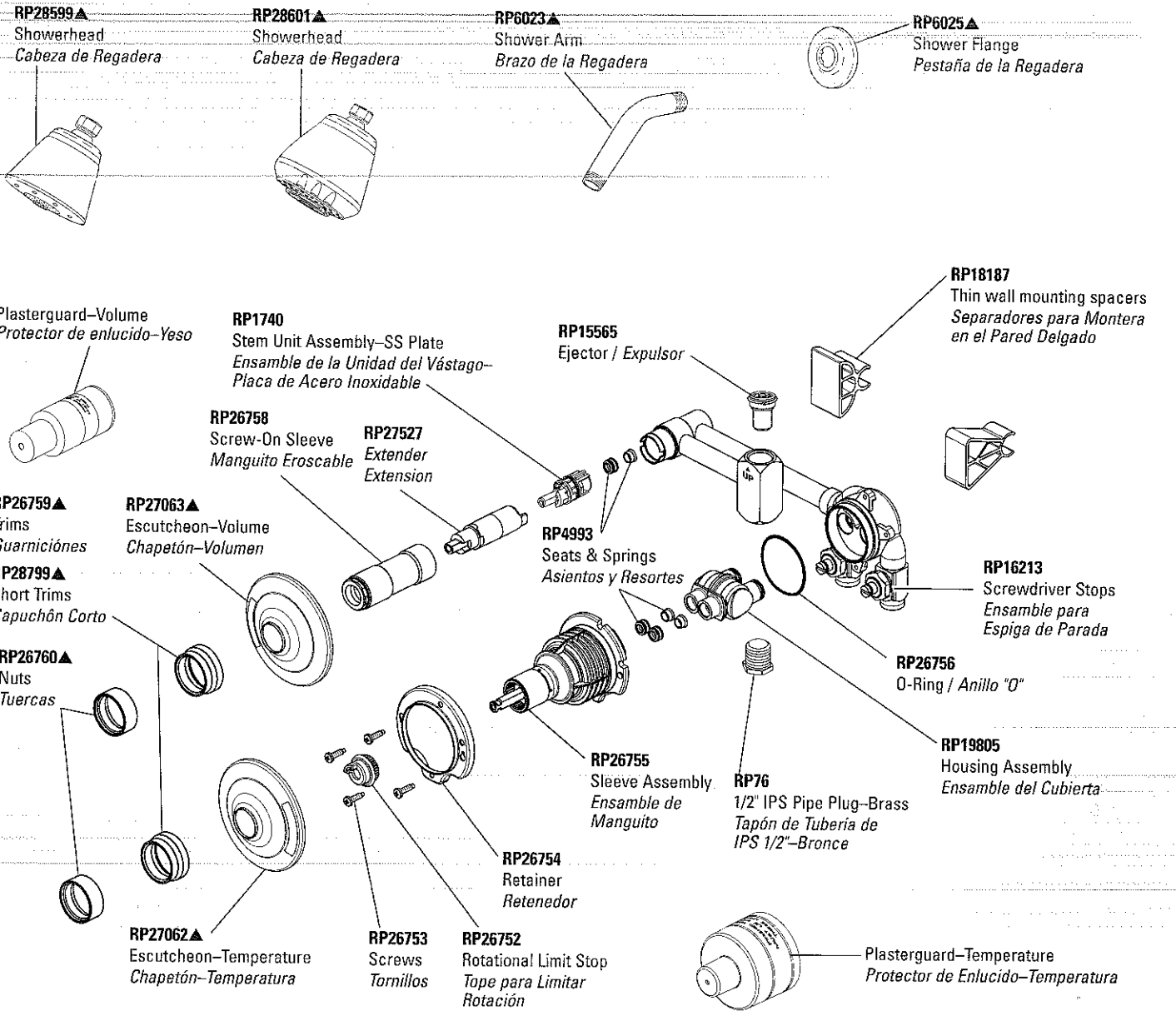

Refer to page 121 for Handles. / Para manijas referirse a la página 121.

Two Handle Bath Valves

Válvulas de Dos Manijas para Bañeras

Jerry Orfanon

Three Handle Bath Valves

Válvulas de Bañeras de Tres Manijas

Classic Series Models/Modelos 2600 & 2800 Series

Classic Series Models/Modelos 2653, 2683, 2861, 2871, 2882, 2885* & 2897 Series

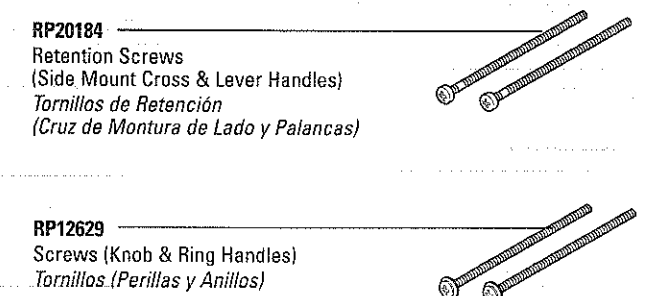
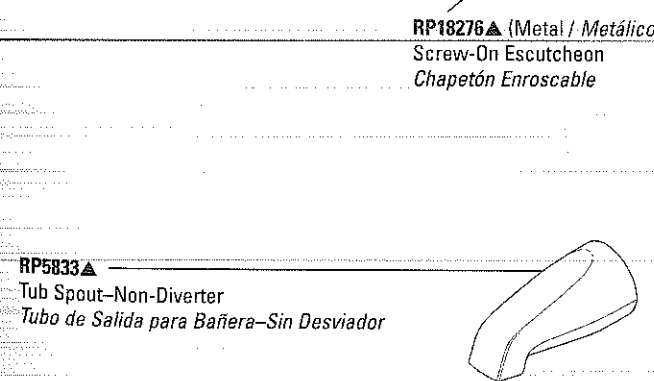
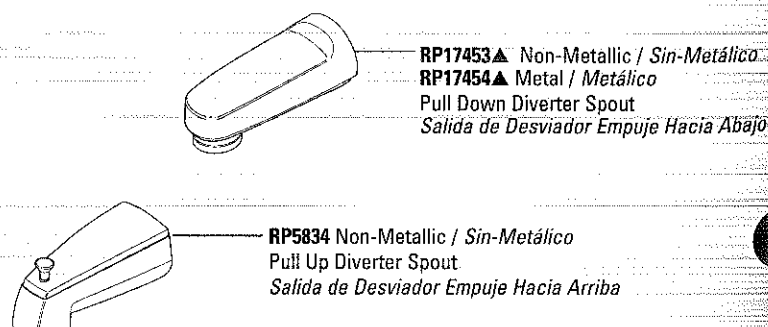
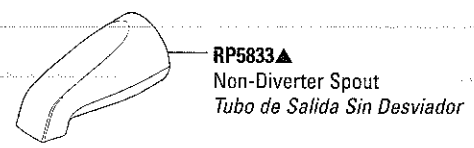
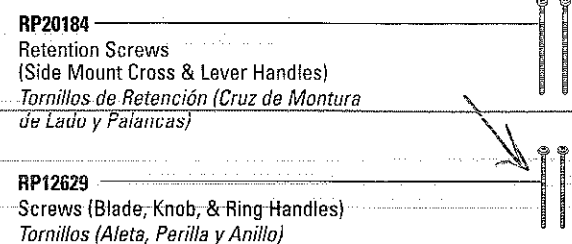
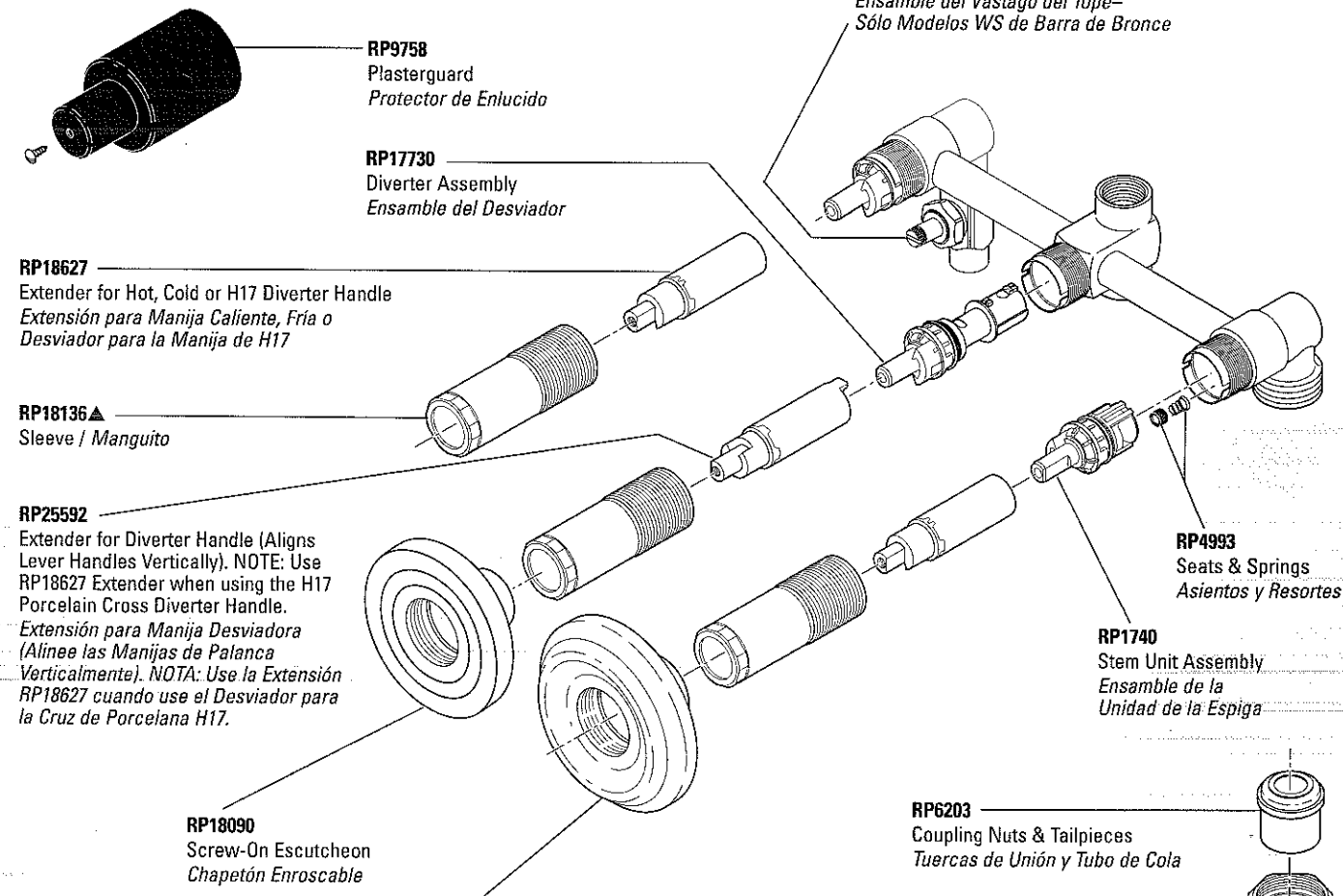
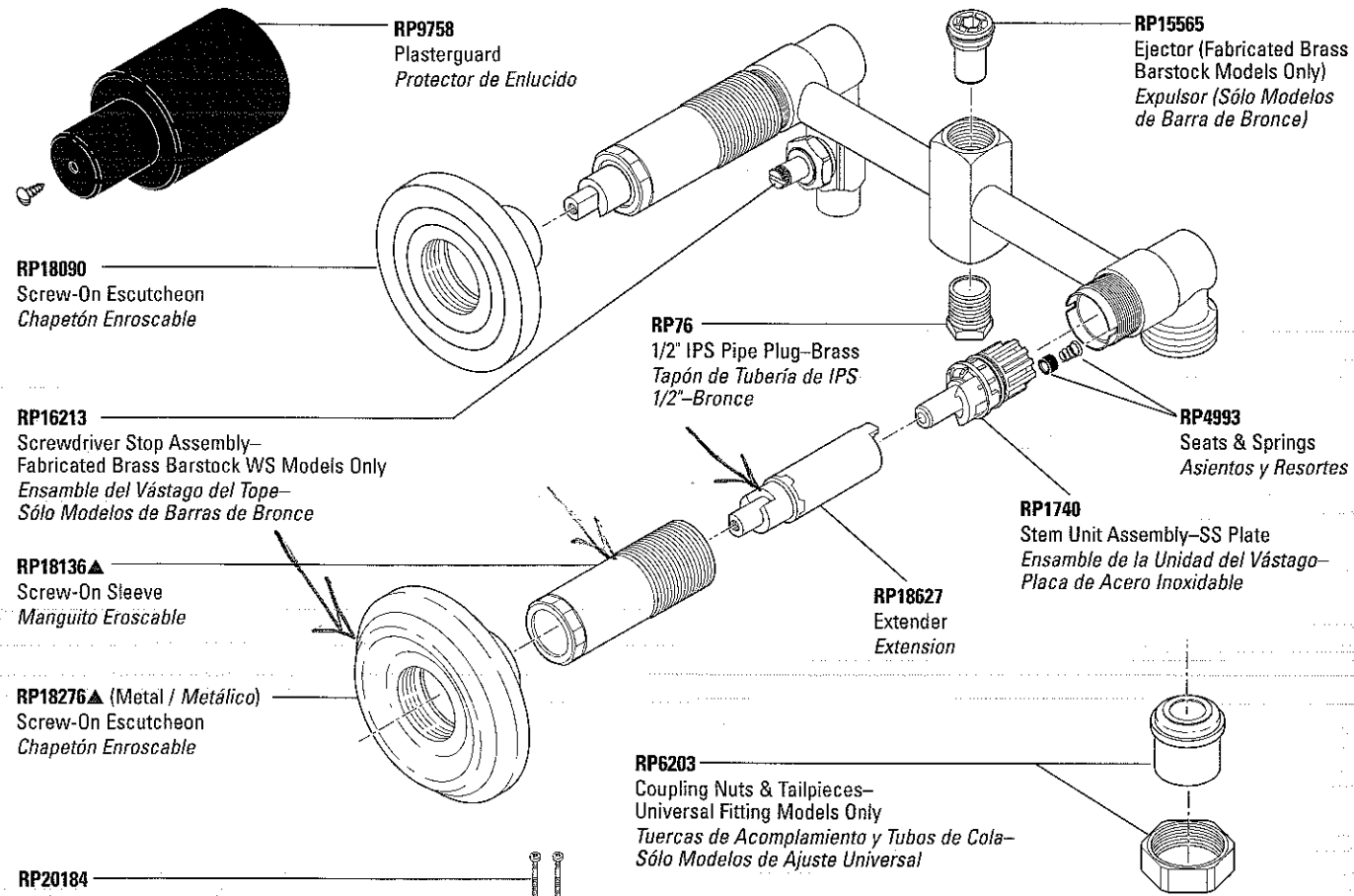
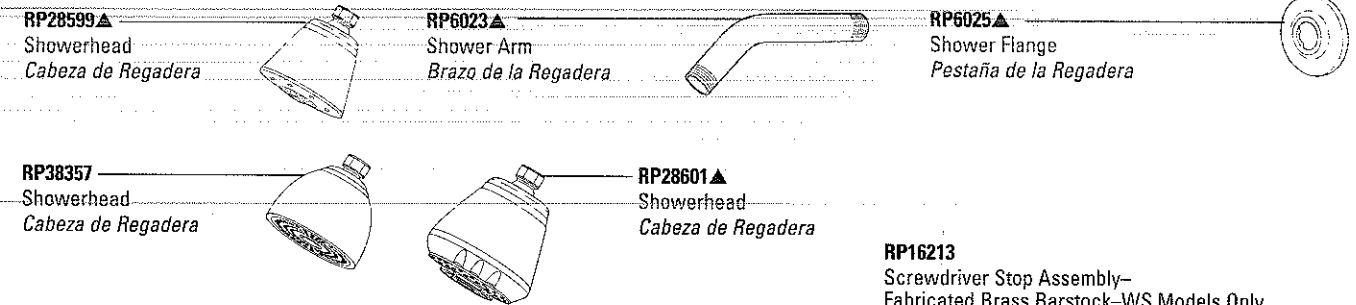
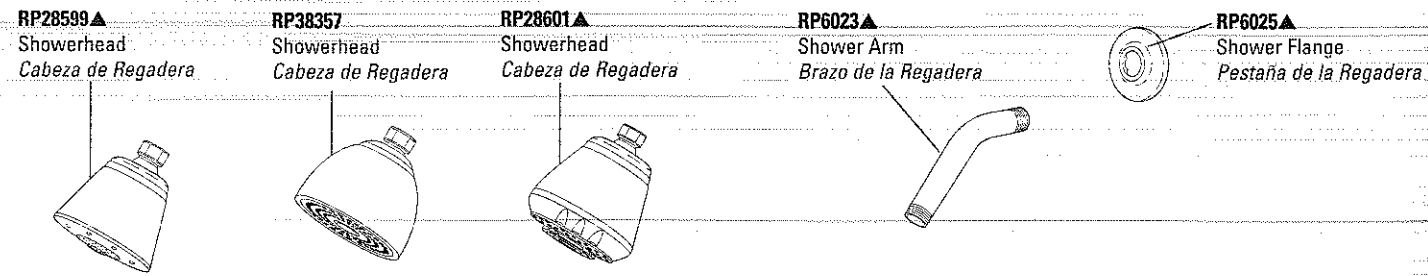

Refer to page 121 for Handles. / Para manijas referirse a la pagina 121.

Refer to page 122 for Handles. / Para manijas referirse a la pagina 122.

TUB/SHOWER

TUB/SHOWER

Tub/Shower Handles and Accents-Single Handle

Manijas y Accesorios para Bañeras/Regaderas-Manija Sencilla

Tub/Shower Handles and Accents-Two Handle

Manijas y Accesorios para Bañeras/Regaderas-Dos Manijas

H71, H71PB
Clear Knob Handle w/Button & Screw-1300/1400 Series
Perilla Transparente con Botón y Tornillo para la Serie 1300/1400

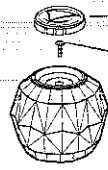

RP20542, RP20542PB
Button (Red/Blue)-Arrow
Botón (Rojo/Azul)-Flecha

RP6369
Screw/Tornillo

H72▲
Standard Lever Handle w/Screw-1300/1400 Series
Manija Estilo Palanca Estándar con Tornillo para la Serie 1300/1400

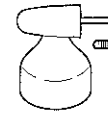

RP26851▲
Spindle/Husillo

RP26865
Set Screw/Tornillo de Ajuste



A72▲
Standard Handle Accent-
1300/1400/1700 Series
Acento para Manija-
1300/1400/1700 Series

H74▲
Innovations® Lever Handle w/Screw-1300/1400 Series
Manija Estilo Palanca Innovations® con Tornillo para la Serie 1300/1400

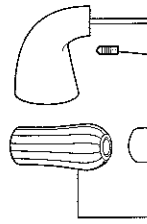

RP26852▲
Spindle / Husillo

RP26865
Set Screw / Tornillo de Ajuste

A74▲
Innovations Handle Accent
Acentos para Manijas - Innovations

A74CL
Clear Accent / Acento de Transparente

H75▲
Neo Style® Lever Handle w/Screw-1300/1400 Series
Manija Estilo Palanca Neo Style® con Tornillo para la Serie 1300/1400

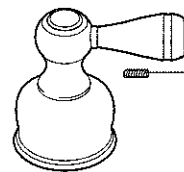

RP26865
Set Screw/Tornillo de Ajuste

H77▲
Neo Style® Porcelain Cross Handle w/Screw-1300/1400 Series
Manija de Porcelana en Forma de Cruz Neo Style® con Tornillo-Serie 1300/1400



RP26865
Set Screw/Tornillo de Ajuste

H78
Metal Blade Handle w/Screw-1300/1400 Series
Manija de Manga de Metal con Tornillo para la Serie 1300/1400



RP6119
Screw/Tornillo

H79▲
Metal Lever Handle w/Screw
Manija Estilo Palanca de Metal con Tornillo

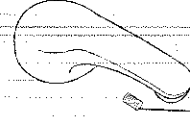

RP152
Set Screw/Tornillo de Ajuste

H712▲
Traditional Porcelain Lever Handle w/Screw-1300/1400 Series
Manija Tradicional Estilo Palanca de Porcelana con Tornillo-Serie 1300/1400

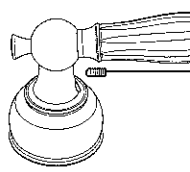

RP26865
Set Screw/Tornillo de Ajuste



A712
Traditional Handle Accent-
1700 Series
Acento para Manija-Traditional
1700 Serie

H715▲
Traditional Metal Lever Handle w/Screw-1300/1400 Series
Manija Tradicional Estilo Palanca de Metal con Tornillo para la Serie 1300/1400

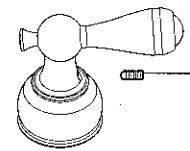

RP26865
Set Screw/Tornillo de Ajuste

H716▲
Victorian™ Lever Handle w/Screw-1300/1400 Series
Manija Estilo Palanca Victorian™ con Tornillo para la Serie 1300/1400

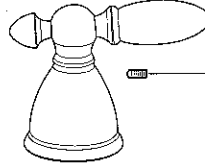

RP26865
Set Screw/Tornillo de Ajuste

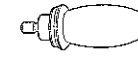

A716▲
Victorian™ Handle Accent-
1700 Series
Acento para Manija-Victorian™
1700 Serie

H717▲
Botanical™ Lever Handle w/Screw-1300/1400 Series
Manija Estilo Palanca Botanical™ con Tornillo para la Serie 1300/1400

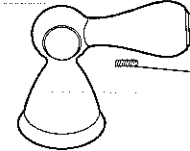

RP26865
Set Screw/Tornillo de Ajuste

RP39379
Interchangeable handle accents:
red, blue, orange, green, and white.
White has "H" and "C" indicators.
Accesorios Intercambiables para Manijas

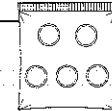

H21, H21PB
Clear Knob Handles w/Buttons
Perillas Transparente con Botones

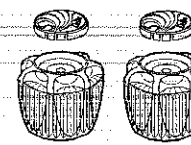

RP18373, RP18373PB
Button Set
(Red/Blue Indicators)
Botones
(Indicadores: Rojo/Azul)

H41, H41PB
Clear Knob Handles w/Buttons
Perillas Transparente con Botones

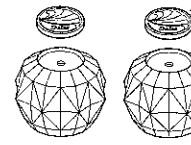

RP18373, RP18373PB
Button Set
(Red/Blue Indicators)
Botones
(Indicadores: Rojo/Azul)

H25▲
Neo Style® Lever Handles w/Screws
Manijas Estilo Palanca Neo Style® con Tornillos

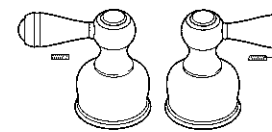

RP25620
Set Screws
Tornillos de Ajuste

H27▲
Neo Style® Porcelain Cross Handles w/Screws
Manijas de Porcelana en Forma de Cruz Neo Style® con Tornillos

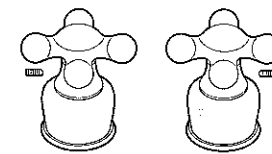

RP25620
Set Screws
Tornillos de Ajuste

H22▲
Standard Lever Handles w/Screws
Manijas Estilo Palancas Estándares con Tornillos

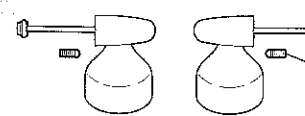

RP26851▲
Spindle/Husillo

RP25620
Set Screws
Tornillos de Ajuste

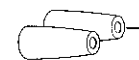

A22▲
Handle Accents
Acentos para Manijas

H24▲
Innovations® Lever Handles w/Screws
Manijas Estilo Palanca Innovations® con Tornillos

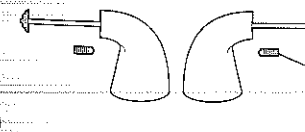

RP26852▲
Spindle/Husillo

RP25620
Set Screws
Tornillos de Ajuste

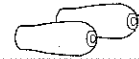

A24▲
Handle Accents
Acentos para Manijas

H28
Metal Blade Handles w/Buttons
Manijas de Manga de Metal con Botones

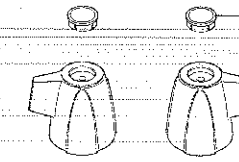

RP2412
Button Set
Botones

RP12629
Screws-
Use w/these
handles.
Tornillos-
Usa con
estas
manijas.

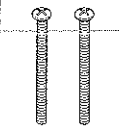

H48
Metal Knob Handles w/Buttons
Perillas de Metal con Botones

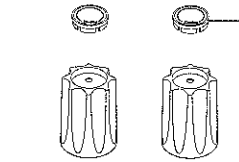

RP19659
Button Set
(Red/Blue Indicators)
Botones
(Indicadores: Rojo/Azul)

H46▲
Neo Style® Metal Cross Handles w/Screws
Manijas de Metal en Forma de Cruz Neo Style® con Tornillos

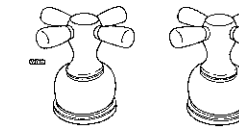

RP25620
Set Screws
Tornillos de Ajuste

RP20184
Screws-
Use w/these
handles.
Tornillos-
Usa con estas
manijas.

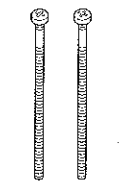

H212▲
Traditional Porcelain Lever Handles w/Screws
Manijas Tradicionales Estilo Palanca de Porcelana con Tornillos

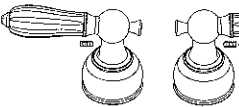

RP25620
Set Screws
Tornillos de Ajuste

H215▲
Traditional Metal Lever Handles w/Screws
Manijas Tradicionales Estilo Palanca de Metal con Tornillos

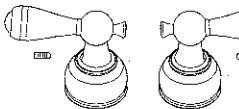

RP25620
Set Screws
Tornillos de Ajuste

H216▲
Victorian™ Lever Handles w/Screws
Manijas Estilo Palanca Victorian™ con Tornillos

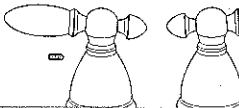

RP25620
Set Screws
Tornillos de Ajuste

H217▲
Botanical™ Lever Handles w/Screws
Manijas Estilo Palanca Botanical™ con Tornillos

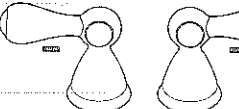

RP25620
Set Screws
Tornillos de Ajuste

RP39377
Interchangeable handle accents:
red, blue, orange, green, and white.
White has "H" and "C" indicators.
Accesorios Intercambiables
para Manijas

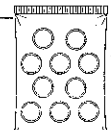

Tub/Shower Handles and Accents-Three Handle Manijas y Accesorios para Bañeras/Regaderas-Tres Manijas

Installation Aids/Repair Kits Herramientas para la Instalación/Herramientas de Repuesto

Diverter Handles-Manijas para Desviadores

H11, H11PB
Clear Knob Handle w/Button
Perilla Transparente con Botón

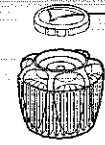

RP18429, RP18429PB
Button-Arrow
Botón-Flecha

H31, H31PB
Clear Knob Handle w/Button
Perilla Transparente con Botón

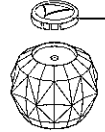

RP18429, RP18429PB
Button-Arrow
Botón-Flecha

H17▲
Neo Style® Porcelain Cross Handle w/Screw
Manija de Porcelana en Forma de Cruz Neo Style®

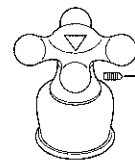

RP25620
Set Screw
Tornillo de Ajuste

H36▲
Neo Style® Metal Cross Handle w/Screw
Manija de Metal en Forma de Cruz Neo Style®



RP25620
Set Screw
Tornillo de Ajuste

H12▲
Standard Lever Handle w/Screw
Manija Estilo Palanca Estándar con Tornillo

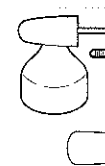

RP26851▲
Spindle/Husillo
RP25620
Set Screw
Tornillo de Ajuste
A12▲
Handle Accent
Acento para Manija

H14▲
Innovations® Lever Handle w/Screw
Manija Estilo Palanca Innovations® con Tornillo



RP26852▲
Spindle/Husillo
RP25620
Set Screw
Tornillo de Ajuste
A14▲
Handle Accent
Acento para Manija

H15▲
Neo Style® Lever Handle w/Screw
Manija Estilo Palanca Neo Style® con Tornillo

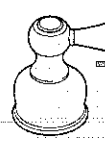

RP25620
Set Screw
Tornillo de Ajuste

Hot/Cold Handles-Manijas Caliente/Frías

H21, H21PB
Clear Knob Handles w/Buttons
Perillas Transparente con Botones

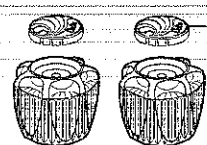

RP18373, RP18373PB
Button Set
(Red/Blue Indicators)
Botones
(Indicadores: Rojo/Azul)

H41, H41PB
Clear Knob Handles w/Buttons
Perillas Transparente con Botones

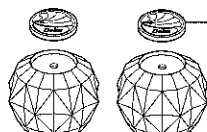

RP18373, RP18373PB
Button Set
(Red/Blue Indicators)
Botones
(Indicadores: Rojo/Azul)

H27▲
Neo Style® Porcelain Cross Handles w/Screws
Manijas de Porcelana en Forma de Cruz Neo Style® con Tornillos

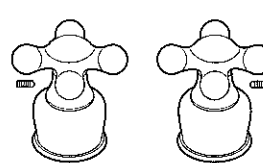

RP25620
Set Screw
Tornillo de Ajuste

H46▲
Neo Style® Metal Cross Handles w/Screws
Manijas de Metal en Forma de Cruz Neo Style® con Tornillos

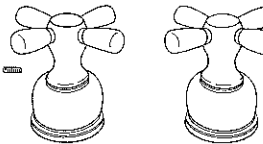

RP25620
Set Screw
Tornillo de Ajuste

H22▲
Standard Lever Handles w/Screws
Manijas Estilo Palancas Estándares con Tornillos

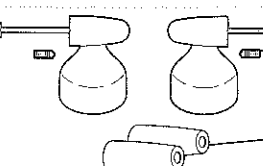

RP26851▲
Spindle/Husillo
RP25620
Set Screw
Tornillo de Ajuste
A22▲
Handle Accents
Acentos para Manijas

H24▲
Innovations® Lever Handles w/Screws
Manijas Estilo Palanca Innovations® con Tornillos

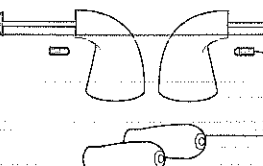

RP26852▲
Spindle/Husillo
RP25620
Set Screw
Tornillo de Ajuste
A24▲
Handle Accents
Acentos para Manijas

H25▲
Neo Style® Lever Handles w/Screws
Manijas Estilo Palanca Neo Style® con Tornillos

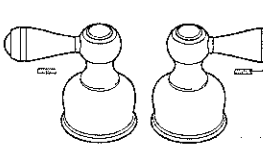

RP25620
Set Screw
Tornillo de Ajuste

TUB/SHOWER

TUB/SHOWER

RP3614
Repair Kit
Herramientas para Reparaciones



RP1974
Wrench-Handle/Adjusting Ring
Llave-Manija/Anillo de Ajuste



RP2011
Conversion Ball-Stainless Steel
(Changes Knob to Lever Handle)
(Cannot install lever handle limit stop kit after this conversion)
Bola de Conversión-Acero Inoxidable (Cambia de Perilla a Manija de Palanca) (No se pueden instalar las herramientas para el tope del límite, de palanca, después de hacer esta conversión)

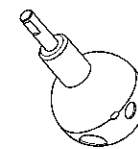

RP16423
Reverse Ball-Stainless Steel
(Corrects Reverse Supply Lines)
Bola de Inversión-Acero Inoxidable (Corrige las Líneas de Contraflujo)

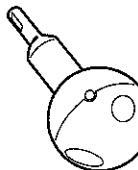

RP6005
Complete Screwdriver Stop-1/2" CWT-1H T/S except Castings
Tope Destornillador Completo-CWT 1/2"-1H T/S Excepto con Piezas Fundidas

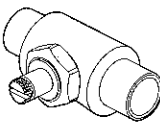

RP5876
Complete Screwdriver Stop-1/2" IPS-1H Tub/Shower except Castings
Tope Destornillador Completo-1/2" IPS-1H Bañera/Regadera Excepto Piezas Fundidas

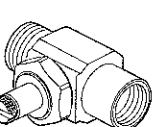

RP6019▲
Deep Escutcheon-600/1600 Series-1" Deeper
Chapetón Hondo-Series 600/1600-1" Mas Hondo



RP21633▲
Deep Escutcheon-1300/1400/1500-1" Deeper-Diagonal Esc. Screw Holes
Chapetón de Hondo-1300/1400/1500-1" Más Hondo-Huecos para los Tornillos Diagonal

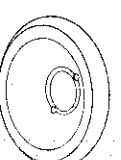

RP21634▲
Deep Escutcheon for Push Button
Diverter (1" Deeper)
Chapetón Hondo para Desviador con Botón Pulsador (1" Más Hondo)



RP19156▲
(1" Longer/1" Más Largo)
Screw-On Sleeve Extenders
(Requiere 2 Kits)
Extensiones de Manguitos Deslice (Dos Herramientas Requerirse)

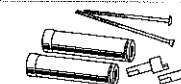

RP12630▲
Screws-2/3H T/S-Lever-10-24x3 3/4"
Tornillos-2/3H T/S-Palanca-10-24x3 3/4"

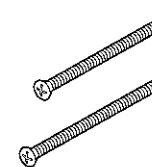

RP29405▲
Conversion Kit Monitor® 1500 to 1700 Series
Control para las Herramientas de Conversión para las series Monitor® desde 1500 hasta 1700

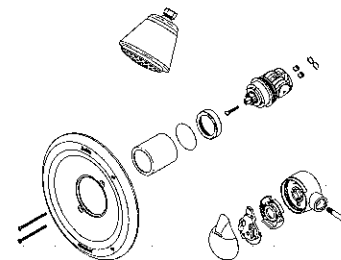

RP5844
Thin Wall Shower Arm or Tub Spout Mounting Kit
Brazo de Regadera para Paredes Delgadas o Herramientas para la Montura del Tubo de Bañera

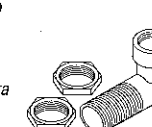

RP18187
Thin Wall Mounting Spacers
Separadores para Paredes Delgadas

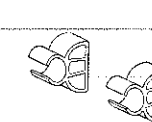

RP18304▲
Screw-On Sleeves & Metal Escutcheons
Manguitos Enroscados y Chapetonas de Metal

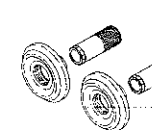

RP18312▲
Screw-On Sleeves & Metal Escutcheons
Manguitos Deslice y Chapetonas de Metálico

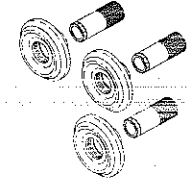

RP34359▲
Victorian™ Collection-Decorative Trim Ring
Aro Decorativo-Victorian™ Colección

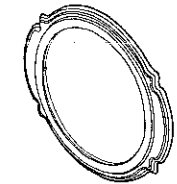

RP40588▲
Michael Graves Collection™-Decorative Trim Ring-Teardrop Design
Aro Decorativo-Diseño en Forma de Lagrima-Michael Graves Collection™

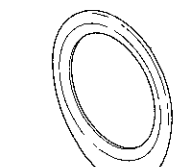

RP40589▲
Michael Graves Collection™-Decorative Trim Ring-Star Design
Aro Decorativo-Diseño en Forma de Estrella-Michael Graves Collection™

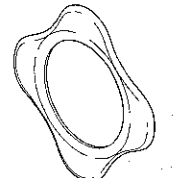

RP32549▲
Supply Elbow
Codo Abastecedor

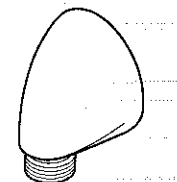

RP32550▲
Shower Arm Diverter for Handshower
Desviador de Brazo Regadera para Regadera de Mano

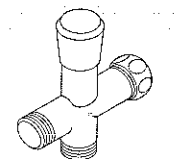

RP29827▲
Renovation Cover Plate
Placa de Cubierta de Renovación

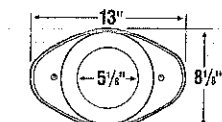

Showerheads, Shower Arms & Shower Flanges

Cabezas, Brazos y Chapas para Regaderas

Tub Spouts and Adapters

Surtidores para Bañeras y Adaptadores

TUB/SHOWER

TUB/SHOWER

RP28599▲
Push-Clean® Showerhead
Cabeza de Regadera
Push-Clean®
2.5 gpm @ 80 psi
9.5 L/min @ 552 kPa

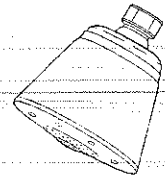

RP28601▲
Dual Spray Touch-Clean® Showerhead
Cabeza de Regadera de Doble
Rociador Touch-Clean®
2.5 gpm @ 80 psi
9.5 L/min @ 552 kPa

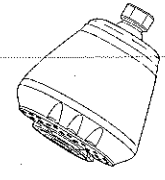
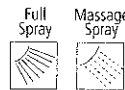

RP28602▲
Ultimate Touch-Clean® Showerhead
Cabeza de Regadera Touch-Clean®
Ultimate
2.5 gpm @ 80 psi
9.5 L/min @ 552 kPa

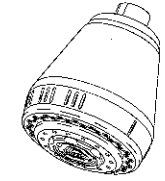
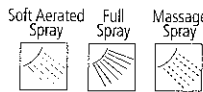

RP34355▲
Traditional Showerhead
Cabeza de Regadera Tradicional
2.5 gpm @ 80 psi
9.5 L/min @ 552 kPa

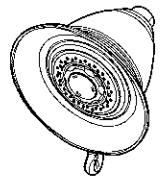
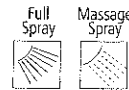

RP38357
Touch-Clean® Showerhead
Cabeza de Regadera
Touch-Clean®
2.5 gpm @ 80 psi
9.5 L/min @ 552 kPa

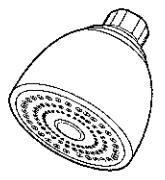

RP40594▲
Michael Graves Collection™
Touch-Clean® Showerhead
Cabeza de Regadera
Touch-Clean® de
Michael Graves
Collection™
2.5 gpm @ 80 psi
9.5 L/min @ 552 kPa

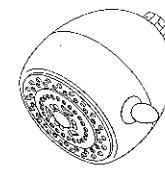
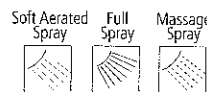

RP31554▲
Shower Arm & Flange
Brazo de Regadera y Chapetón

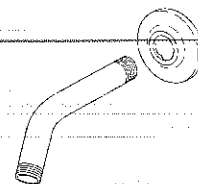

RP6023▲
Shower Arm
For Standard & Traditional Applications
Brazo de Regadera
Estándar y Tradicional

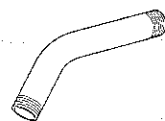

RP6025▲
Shower Flange
Chapetón de Regadera

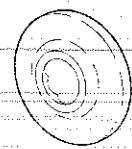

RP37079▲
Traditional Shower Arm & Flange
Brazo de Regadera y Brida Tradicional

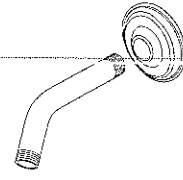

RP34356▲
Traditional Shower Flange
Chapetón de Regadera Tradicional



RP38452▲
Botanical™ Shower Flange
Chapa para Regaderas Botanical™

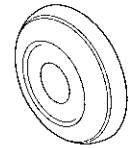

RP40593▲
Michael Graves Collection™ Shower Arm
Brazo de Regadera
de Michael Graves Collection™

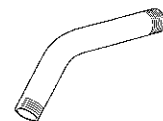

RP40592▲
Michael Graves Collection™ Shower Flange
Chapa para Regaderas
de Michael Graves Collection™



RP6124▲
Showerhead Adjustable
Volume Control
Cabeza de Regadera con
Control de Volumen

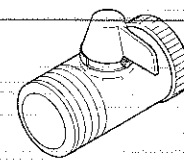

RP32550▲
Shower Arm Diverter
for Handshower
Desviador de Brazo Regadera
para Regadera de Mano

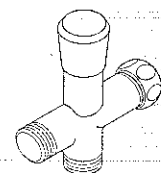

RP17453▲
Standard pull-down diverter spout
6" total length
Sweat onto 1/2" C.W.T.
Thread onto 1/2" I.P.S. nipple
Non-metallic
RP12307 adapter assembly included

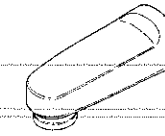

RP5836
Slip-on pull-down diverter spout
6" total length
Slip onto 1/2" C.W.T.
Non-metallic
RP33794 adapter assembly included

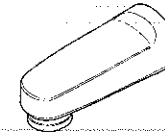

RP17454▲
Standard pull-down diverter spout
6" total length
Sweat onto 1/2" C.W.T.
Thread onto 1/2" I.P.S. nipple
Metal
RP12307 adapter assembly included

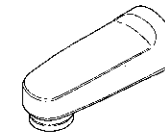

RP3914
Hand shower diverter spout for tub valves only
5" total length - Pull-out to divert
Thread onto 1/2" or 3/4" I.P.S.
Metal

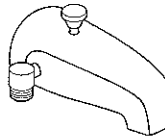

RP19820
Slip-On diverter spout
5 1/2" total length
Pull-up to divert
Slip onto 1/2" C.W.T.
Non-metallic
RP33794 adapter assembly included

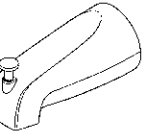

RP5834
Standard diverter spout
5 1/2" total length
Pull-up to divert
Sweat onto 1/2" C.W.T.
Thread onto 1/2" I.P.S.
Non-metallic
RP12307 adapter assembly included

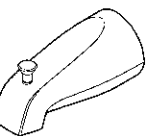

RP19895
Standard diverter spout
5 1/2" total length
Threads in nose of spout
Pull-up to divert
Thread onto 1/2" I.P.S. nipple
Metal

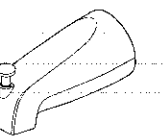

RP34357▲
Traditional diverter
7 1/2" total length
Pull-up to divert
Sweat onto 1/2" C.W.T.
Thread onto 1/2" I.P.S. nipple
50/50
RP12307 adapter assembly included

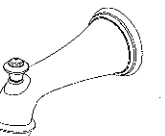

RP38449▲
Botanical™ diverter spout
6 1/2" total length
Pull-up to divert
Sweat onto 1/2" C.W.T.
Thread onto 1/2" I.P.S. nipple
50/50
RP12307 adapter assembly included

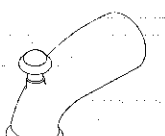

RP38450▲
Botanical™ diverter spout
7 5/8" total length
Pull-up to divert
Sweat onto 1/2" C.W.T.
Thread onto 1/2" I.P.S. nipple
50/50
RP12307 adapter assembly included

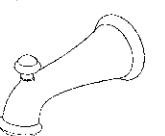

RP40625▲
Michael Graves Collection™
Diverter spout
7" total length
Pull-up to divert
Sweat onto 1/2" C.W.T.
Thread onto 1/2" I.P.S. nipple
Non-metallic
RP12307 adapter assembly included

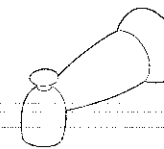

RP36497▲
Slip-on diverter spout
7" total length
Pull-up to divert
Slip onto 1/2" C.W.T.
Metal

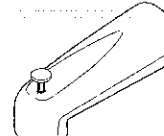

RP36498▲
Slip-on non-diverter spout
7" total length
Slip onto 1/2" C.W.T.
Metal

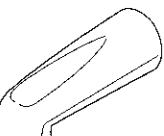

RP18396▲
Roman Tub spout
Wall mount
9" total length
Thread onto 1/2" I.P.S. nipple
Metal

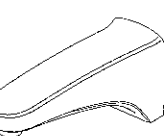

RP5835
Slip-on non-diverter spout
5 1/4" total length
Slip onto 1/2" C.W.T.
Metal



RP5833▲
Non-diverter spout
5 1/4" total length
Thread onto 1/2" I.P.S. nipple
Threads in nose of spout
Metal



RP12307
Adapter Assembly -
sweat onto 1/2" C.W.T.
or thread onto 1/2" I.P.S.

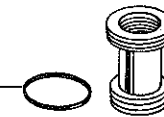

RP1745
O-Ring

RP33794
Adapter Assembly - slip onto 1/2" C.W.T.

RP33482
Inside O-Ring

RP1745
Outside O-Ring

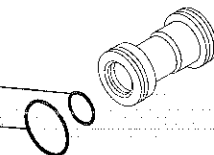

RP17472
Removable Decal for Pull-Down
Spout Operation



RP17829
Wall Decal-Pull-Down Diverter
Tub Spout Operation

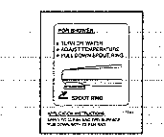

Delta Personal Hand Held Showers & Accessories Regaderas de Mano Personal y Accesorios de Delta

Delta Personal Hand Held Showers & Accessories Regaderas de Mano Personal y Accesorios de Delta

Model/Modelo RP32538 Series

RP33098
Hand Piece
Regadera de Mano

RP12503
Vacuum Breaker
Rompe-Vacio

RP14990
Hose w/Gaskets
Manguera con Empaques

RP33094
Wall Mount Bracket
Abrazadera de Montura para la Pared

Model/Modelo RP32540 Series

RP14991▲
Hand Piece—Five Function
Regadera de Mano

RP12503▲
Vacuum Breaker
Rompe-Vacio

RP14990▲
Hose w/Gaskets
Manguera con Empaques

RP33096▲
Wall Mount Bracket
Abrazadera de Montura para la Pared

HANDSHOWER

HANDSHOWER

Models/Modelos RP32539 & RP32541 Series

RP14991▲
Hand Piece (Model RP32541)
Five-function
Regadera de Mano

RP33098
Hand Piece (Model RP32539)
Regadera de Mano

RP12503▲
Vacuum Breaker
Rompe-Vacio

RP14990▲
Hose w/Gaskets
Manguera con Empaques

Push Button
Botón de presión

Anchor
Sujetadores

Screws / Tornillos

Bracket Cover
Cubierta del soporte de barras

Bar / Barra

Slide Mechanism
Mecanismo de deslizamiento

Wall Bracket
Soporte de Pared

RP33097▲
Wall Bar
Barra para la Pared

Optional / Opcional

RP32549▲
Wall Supply Elbow & Flange – 90°
Suministros de Pared para Codo y Brida – 90°

RP32550▲
Shower Arm Diverter for Handshower
Desviador de Brazo Regadera para Regadera de Mano

RP3914 (Chrome only / Sólo Cromo)
Diverter Spout for Hand Shower
(for tub only valves 1/2" or 3/4" IPS)
Salida Desviador para Regadera de Mano (para válvulas bañeras 1/2" o 3/4" de IPS)

RP6124▲
Adjustable Volume Control
(attaches to shower arm)
Control ajustable de volumen
(se fija al brazo de la regadera)

Deck/Ledge Mount Roman Tub Faucets Llaves para Bañeras Romanas

Classic Series Model/Modelo 2708* Series

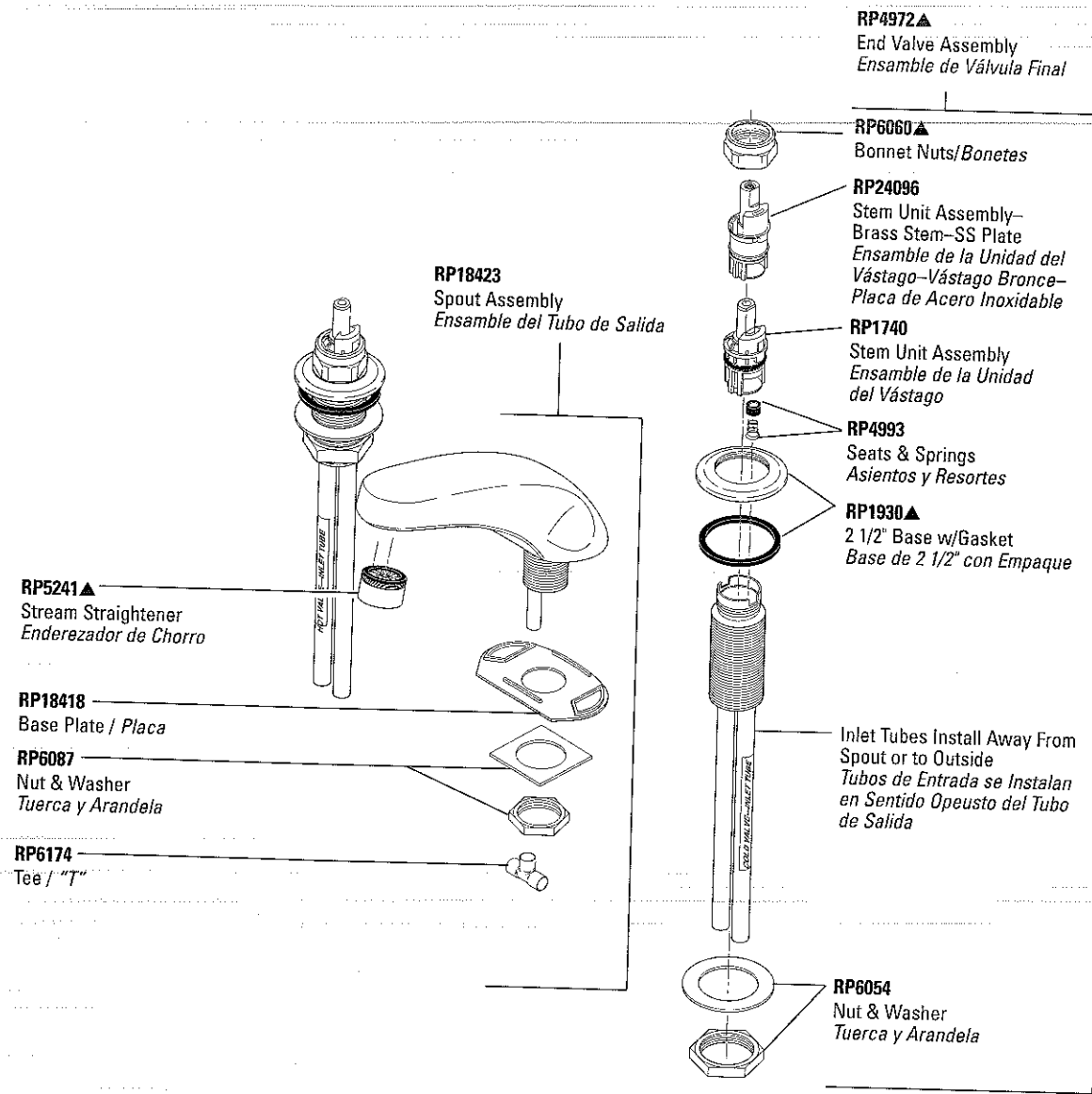

Deck/Ledge Mount Roman Tub Faucets Llaves para Bañeras Romanas

Classic Series Models/Modelos 2710 & 2711 Series

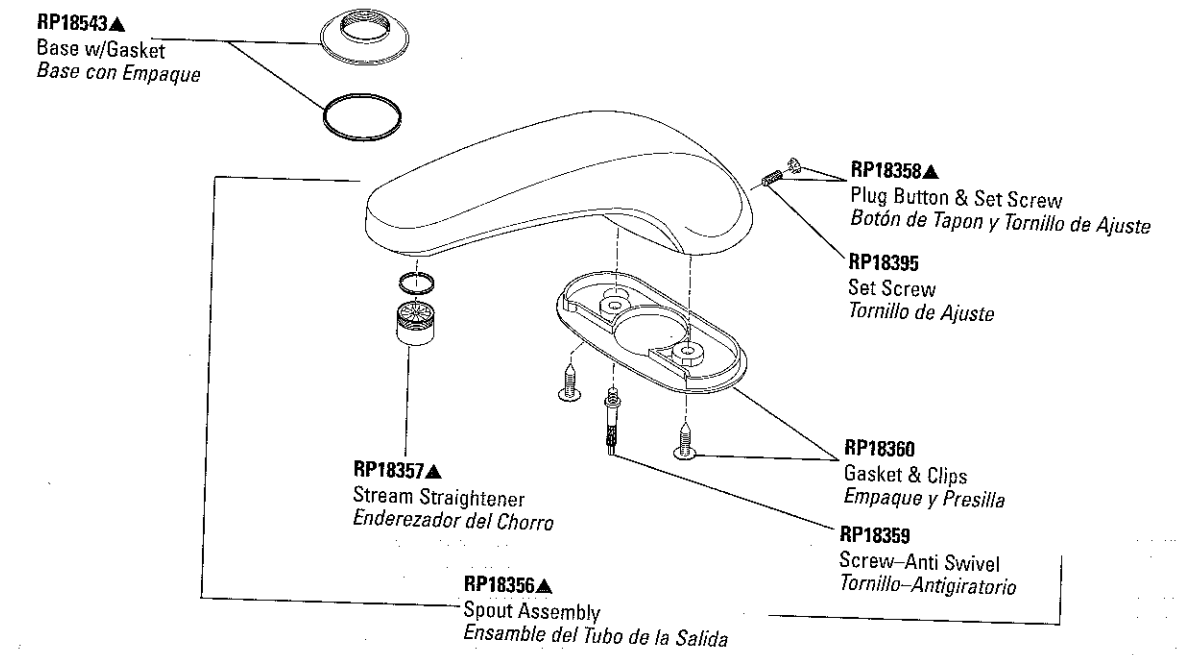

ROMAN TUB

ROMAN TUB

Refer to page 152 for Handles. / Para manijas referirse a la pagina 152

Refer to page 152 for Handles. / Para manijas referirse a la pagina 152

Refer to pages 144-148 for rough-in kits. / Para Equipo para Preparación de Instalación referirse a las paginas 144-148

Wall Mount Roman Tub Faucets Montura de Parad para Llaves de Bañeras Romanas

Classic Series Model/Modelo 2714* Series

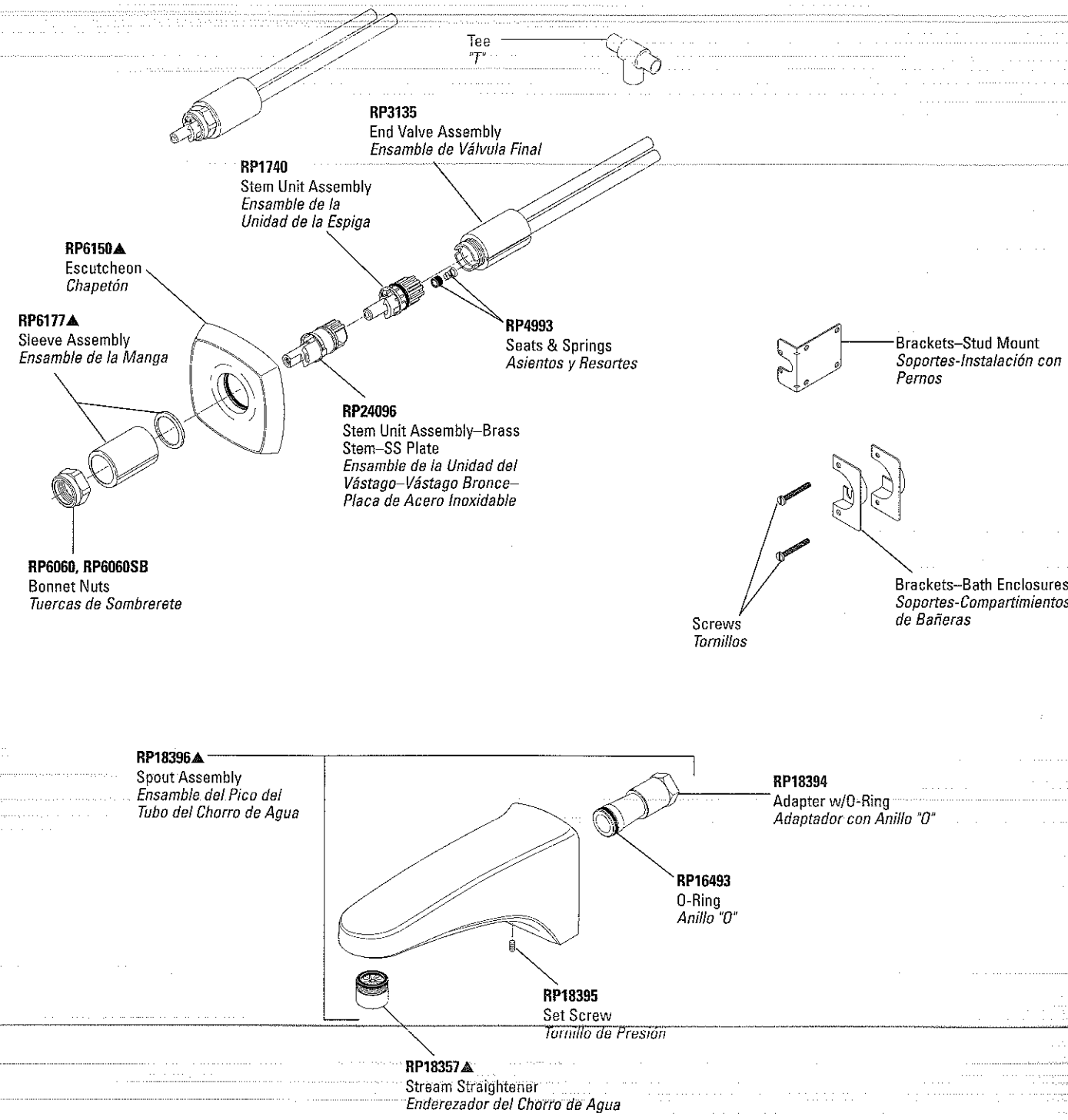

4-Hole Roman Tub & Hand-held Shower Bañera Romana de 4 agujeros con regadera manual

Classic Series Model/Modelo 2715 Series

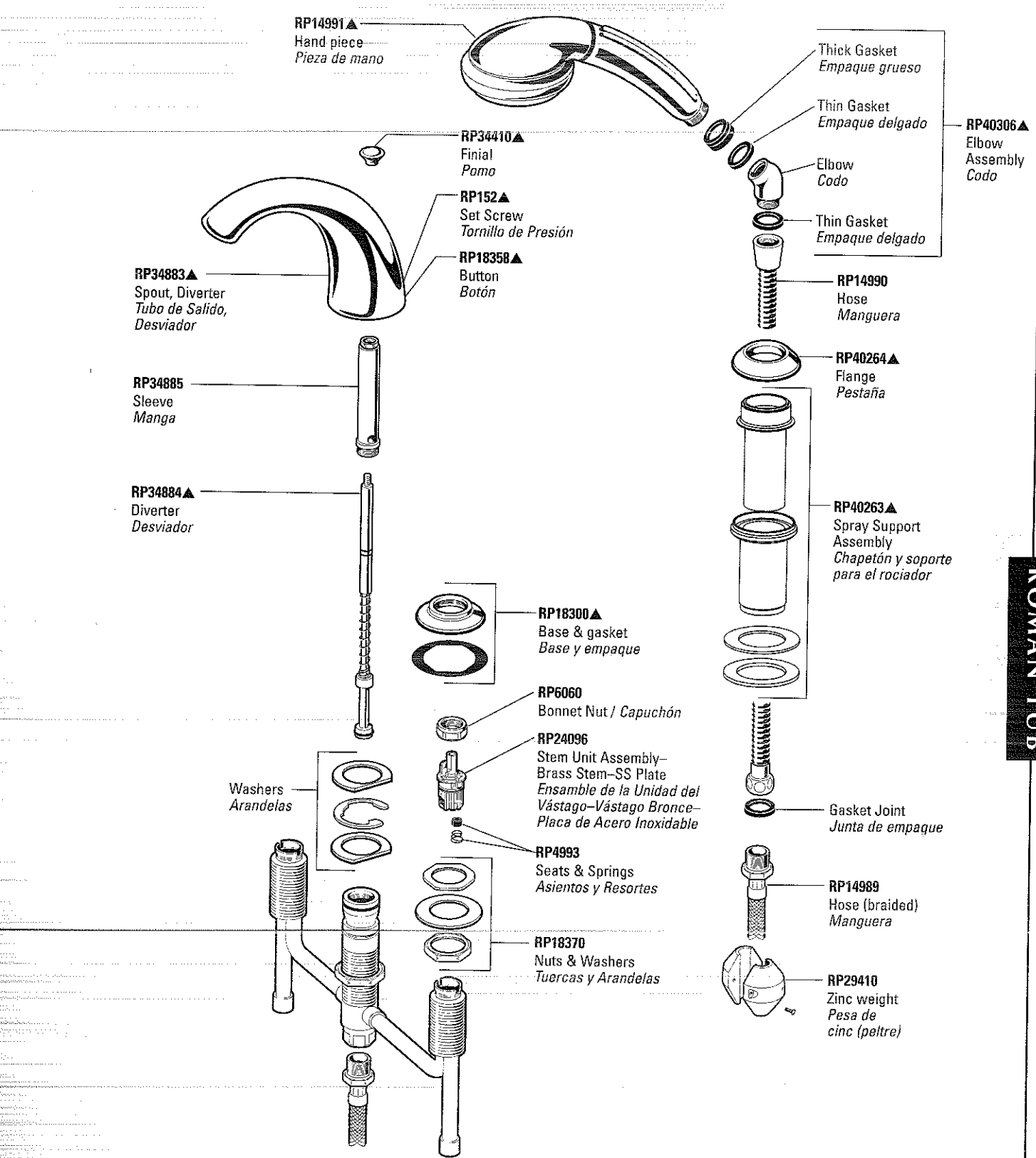

ROMAN TUB

ROMAN TUB

Refer to page 152 for Handles. / Para manijas referirse a la pagina 152.

Refer to page 152 for Handles. / Para manijas referirse a la pagina 152.

3-Hole Roman Tub Bañera Romana de 3 agujeros

Classic Series Model/Modelo 2705 Series

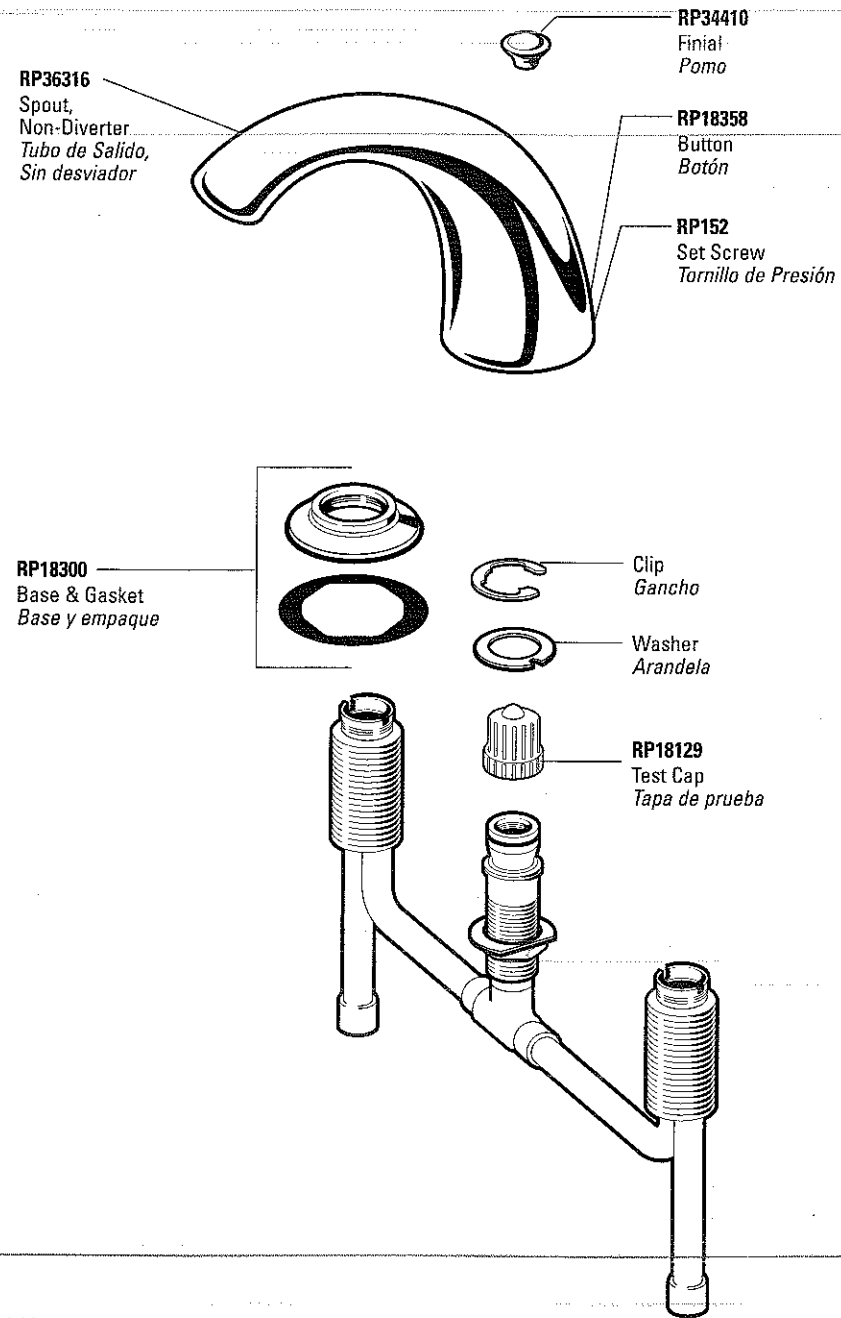

Deck/Ledge Mount Roman Tub Faucets Llaves para Bañeras Romanas

Innovations® Series Models/Modelos 2730 & 2731 Series

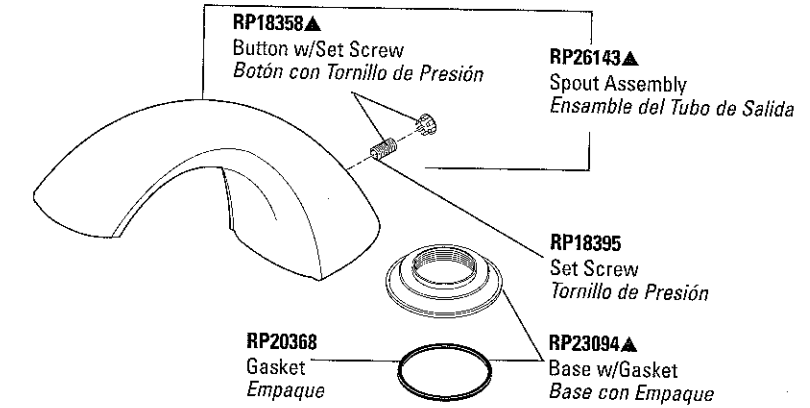

ROMAN TUB

ROMAN TUB

Deck/Ledge Mount Roman Tub Faucets Llaves para Bañeras Romanas

Classic Series Model/Modelo 2750* Series

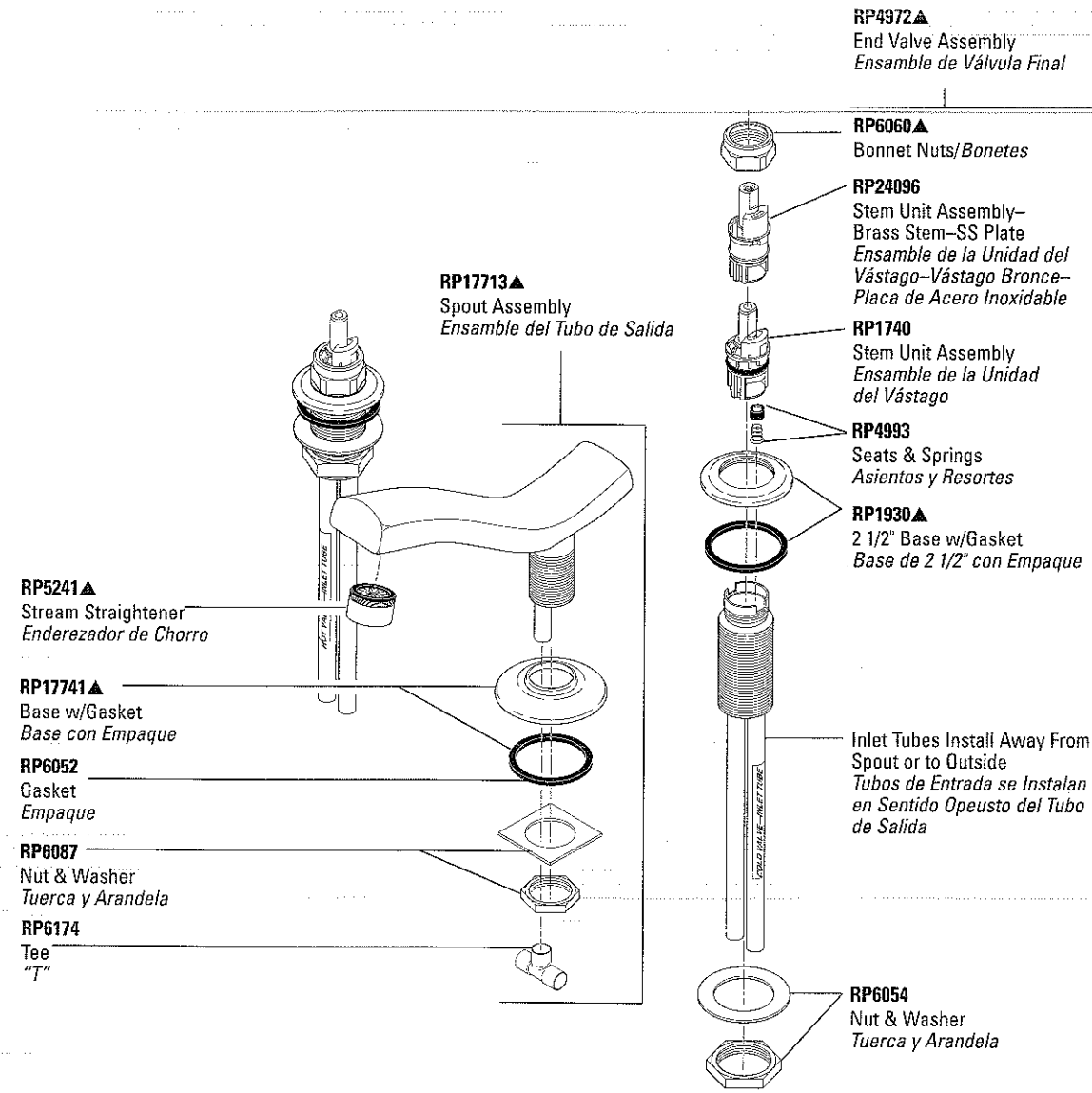

Deck/Ledge Mount Roman Tub Faucets Llaves para Bañeras Romanas

Victorian™ Collection Models/Modelos 2755 & 2756 Series

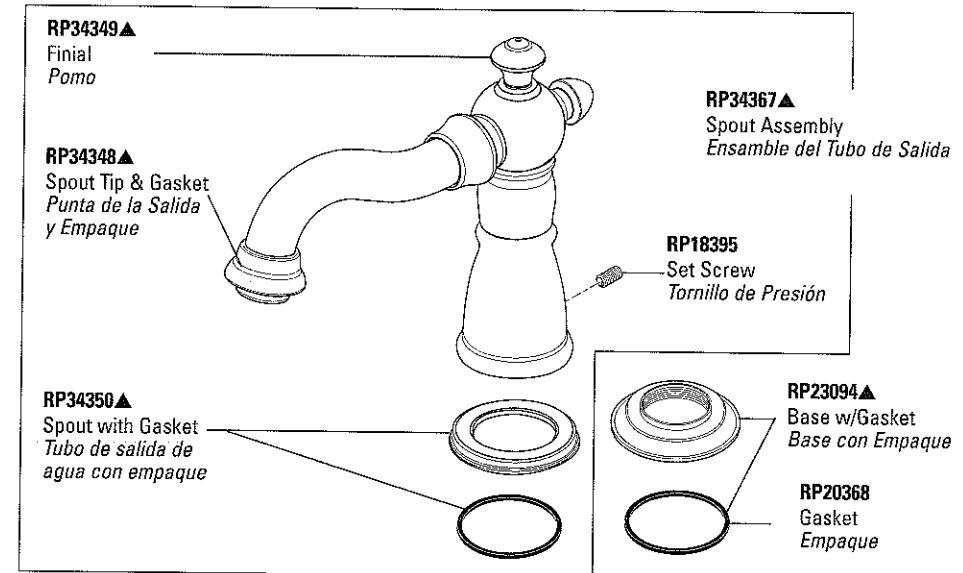

ROMAN TUB

ROMAN TUB

Refer to page 152 for Handles. / Para manijas referirse a la pagina 152.

Refer to page 152 for Handles. / Para manijas referirse a la pagina 152.

Refer to pages 144-148 for rough-in kits. / Para Equipo para Preparación de Instalación referirse a las paginas 144-148.

Deck/Ledge Mount Roman Tub Faucets

Llaves para Bañeras Romanas

Botanical™ Bath Collection
 Freesia™ Series Models/Modelos 2760* & 2761* Series

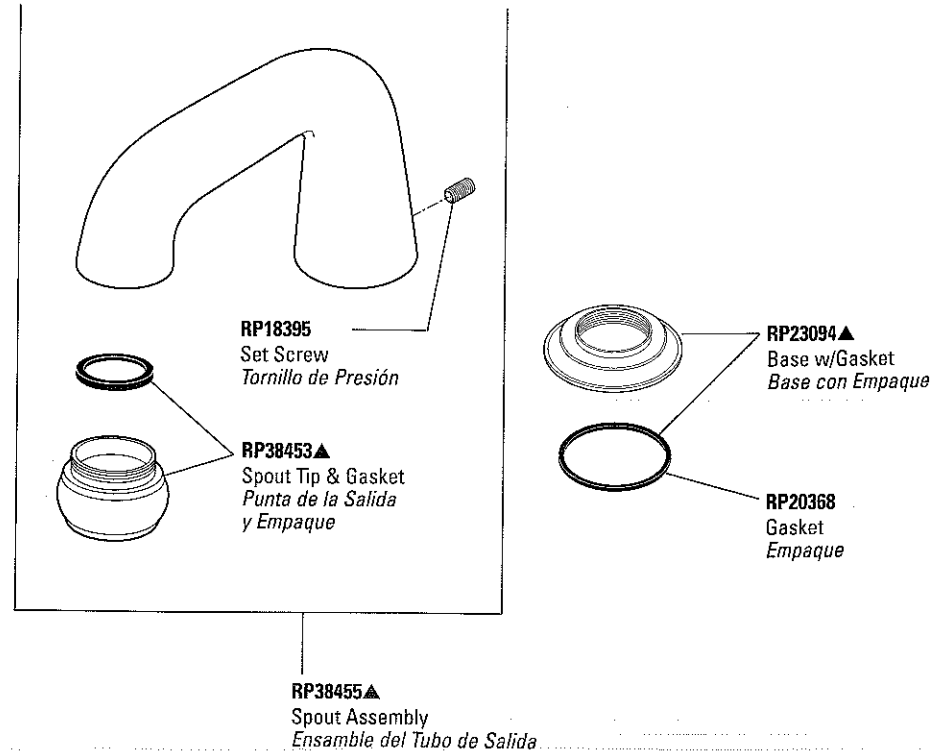

Deck/Ledge Mount Roman Tub Faucets

Llaves para Bañeras Romanas

Botanical™ Bath Collection
 Statice Series Models/Modelos 2765 & 2766 Series

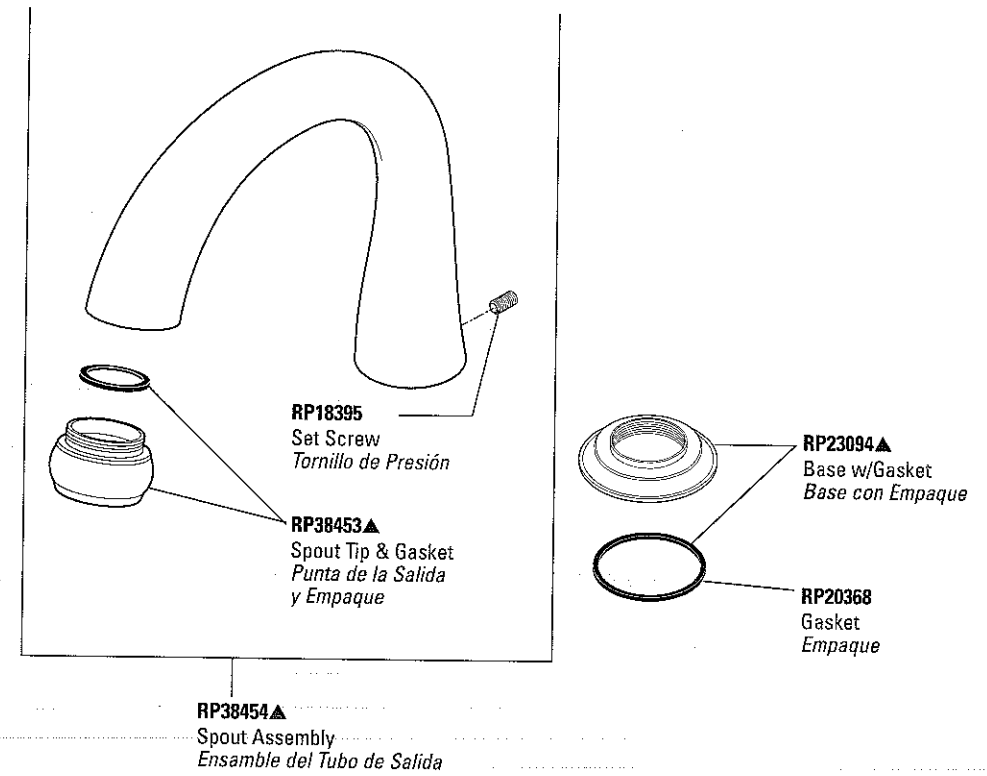

ROMAN TUB

ROMAN TUB

Refer to page 152 for Handles. / Para manijas referirse a las paginas 152.
 Refer to pages 144-148 for rough-in kits. / Para Equipo para Preparación de Instalación referirse a las paginas 144-148.

Refer to page 152 for Handles. / Para manijas referirse a las paginas 152.
 Refer to pages 144-148 for rough-in kits. / Para Equipo para Preparación de Instalación referirse a las paginas 144-148.

Deck/Ledge Mount Roman Tub Faucets Llaves para Bañeras Romanas

NEO STYLE® Series Models/Modelos 2767 & 2768* Series

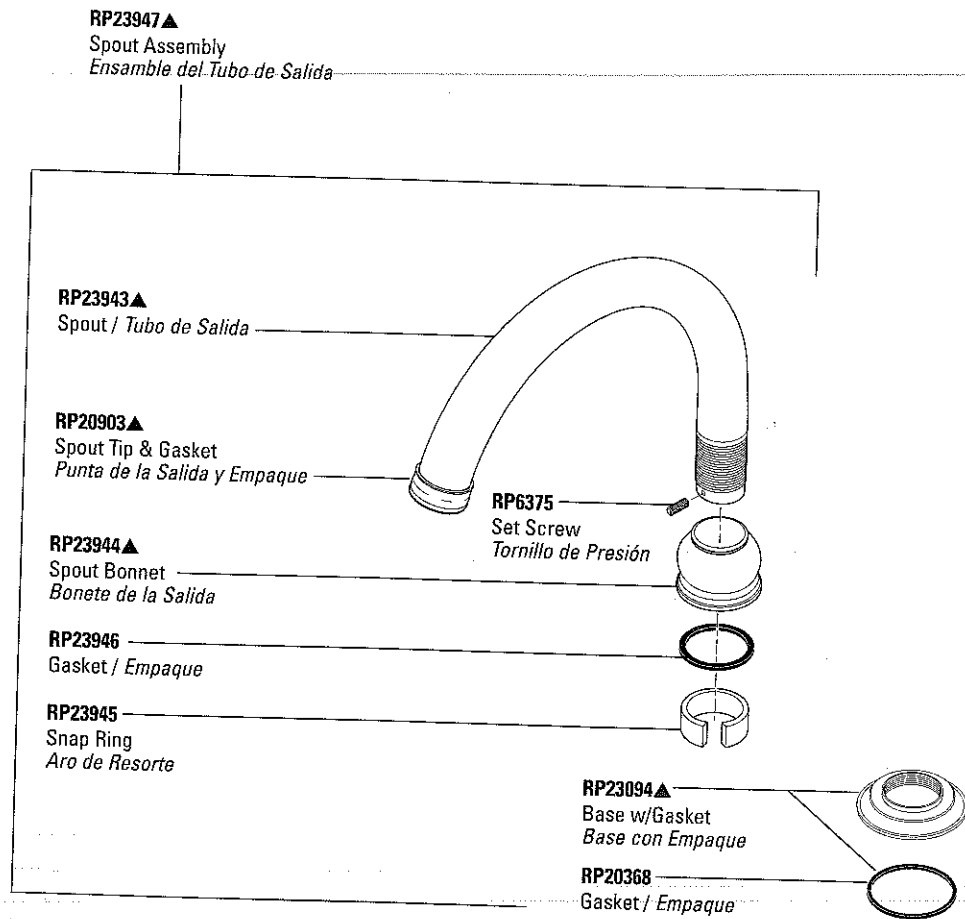

Deck/Ledge Mount Roman Tub Faucets Llaves para Bañeras Romanas

Teapot Spout Series Models/Modelos 2770 & 2771* Series

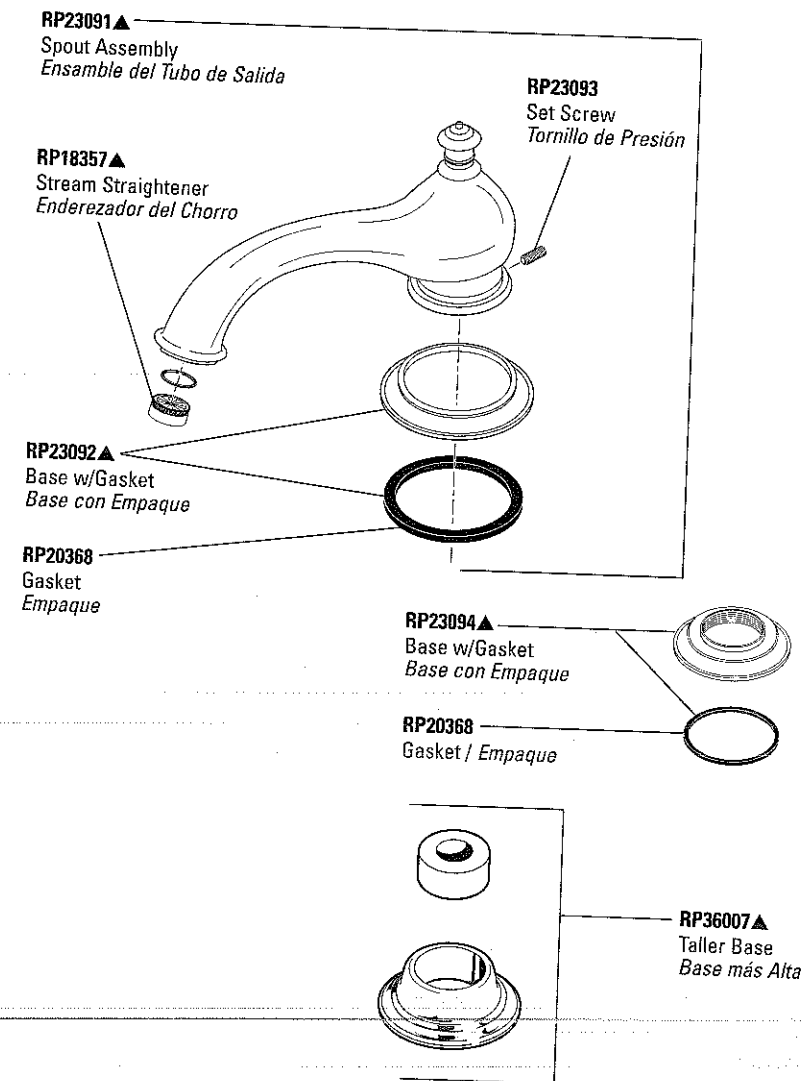

ROMAN TUB

ROMAN TUB

Refer to page 152 for Handles. / Para manijas referirse a la paginas 152.
Refer to pages 144-148 for rough-in kits. / Para Equipo para Preparación de Instalación referirse a las paginas 144-148.

Refer to page 152 for Handles. / Para manijas referirse a la paginas 152.
Refer to pages 144-148 for rough-in kits. / Para Equipo para Preparación de Instalación referirse a las paginas 144-148.

Deck/Ledge Mount Roman Tub Faucets Llaves para Bañeras Romanas

C-Spout Series Models/Modelos 2780 & 2781 Series

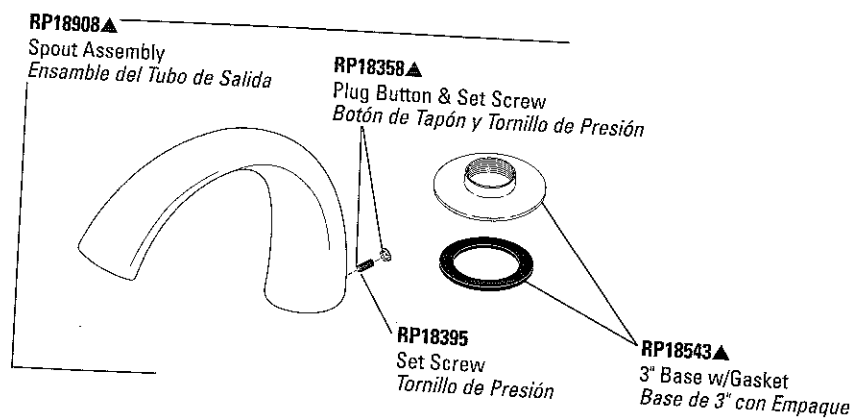

Deck/Ledge Mount Roman Tub Faucets Llaves para Bañeras Romanas

MICHAEL GRAVES
COLLECTION

Models/Modelos 2788 & 2789 Series

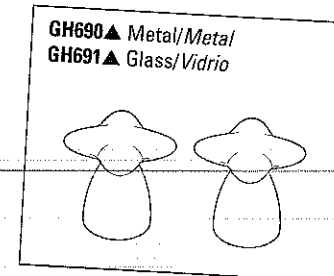
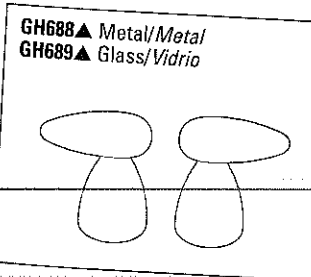
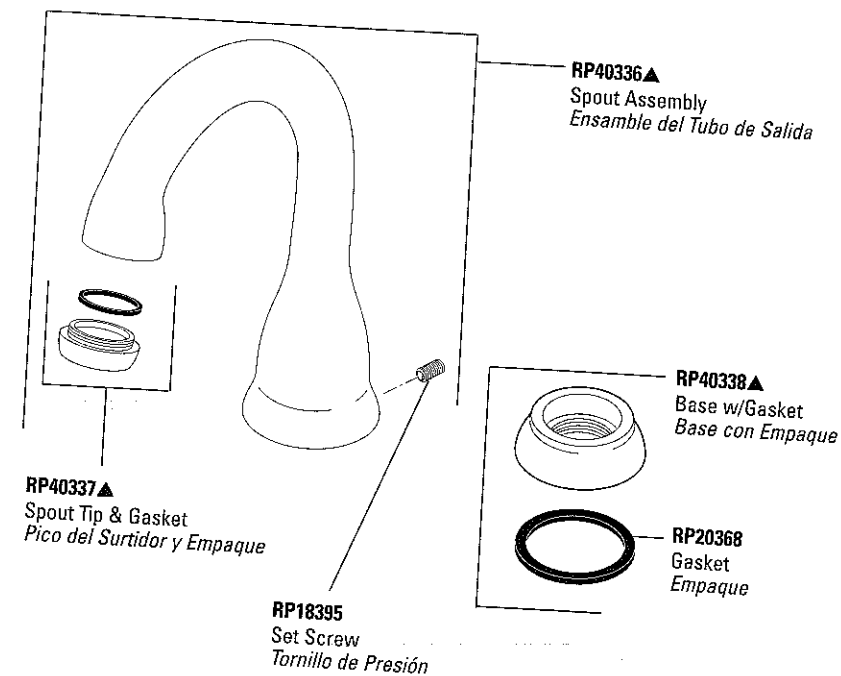

Refer to page 152 for Handles. / Para manijas referirse a las paginas 152.

Refer to pages 144-148 for rough-in kits. / Para Equipo para Preparación de Instalación referirse a las paginas 144-148.

Refer to pages 144-148 for rough-in kits. / Para Equipo para Preparación de Instalación referirse a las paginas 144-148.

4-Hole Roman Tub & Hand-held Shower Bañera Romana de 4 agujeros con regadera manual

Victorian™ Collection Model/Modelo 4756 Series

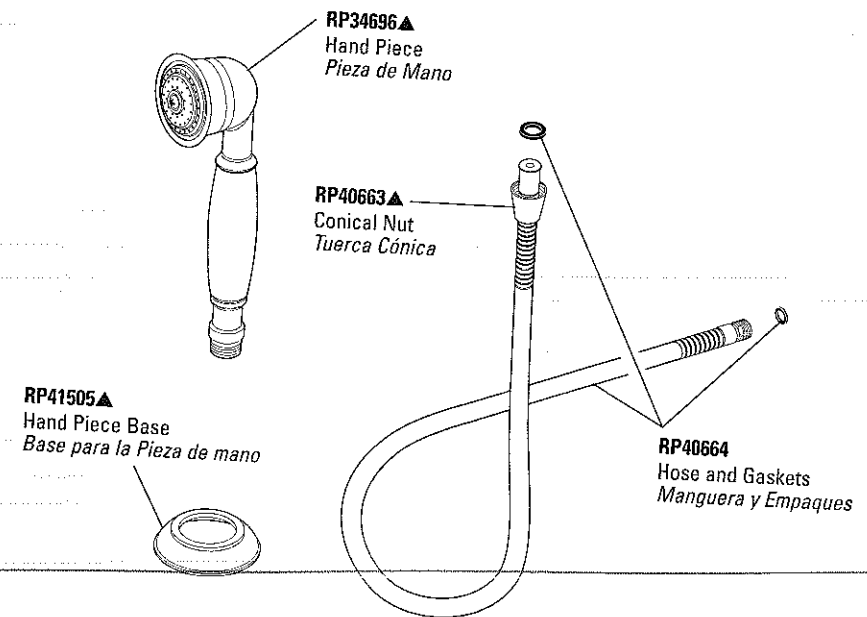
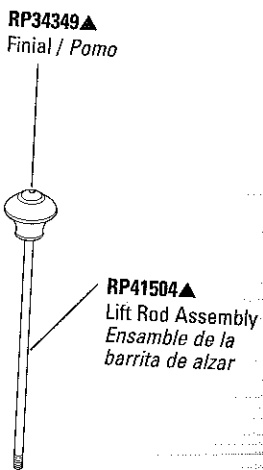
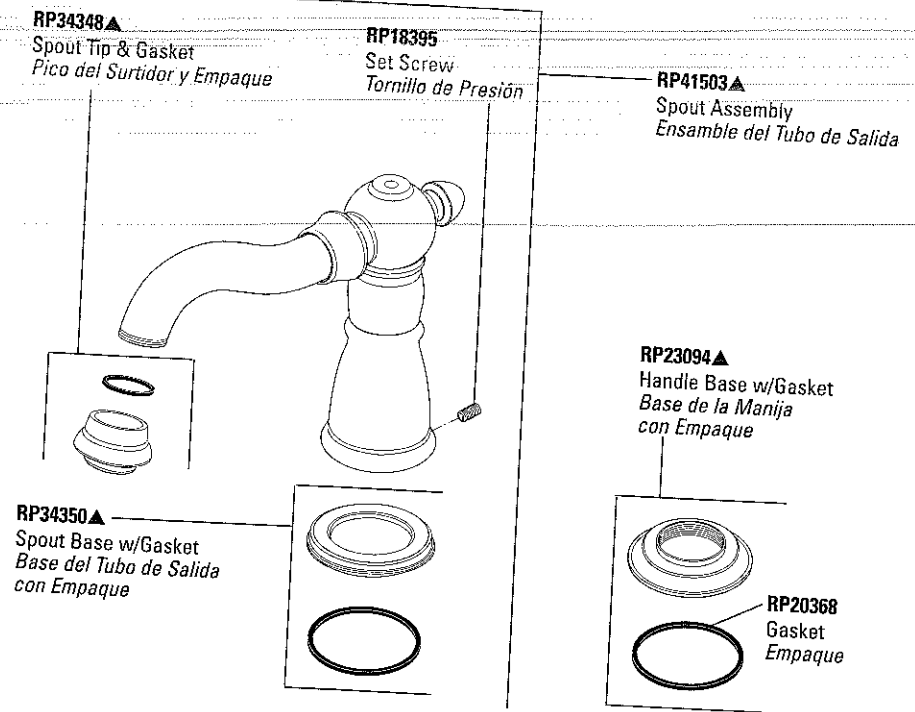

4-Hole Roman Tub & Hand-held Shower Bañera Romana de 4 agujeros con regadera manual

MICHAEL GRAVES
COLLECTION

Model/Modelo 4789 Series

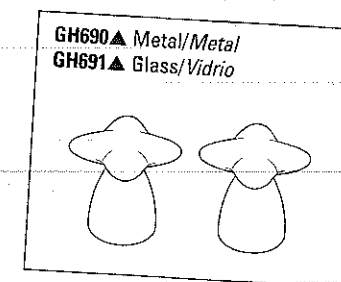
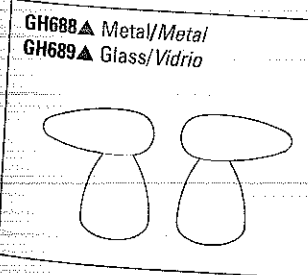
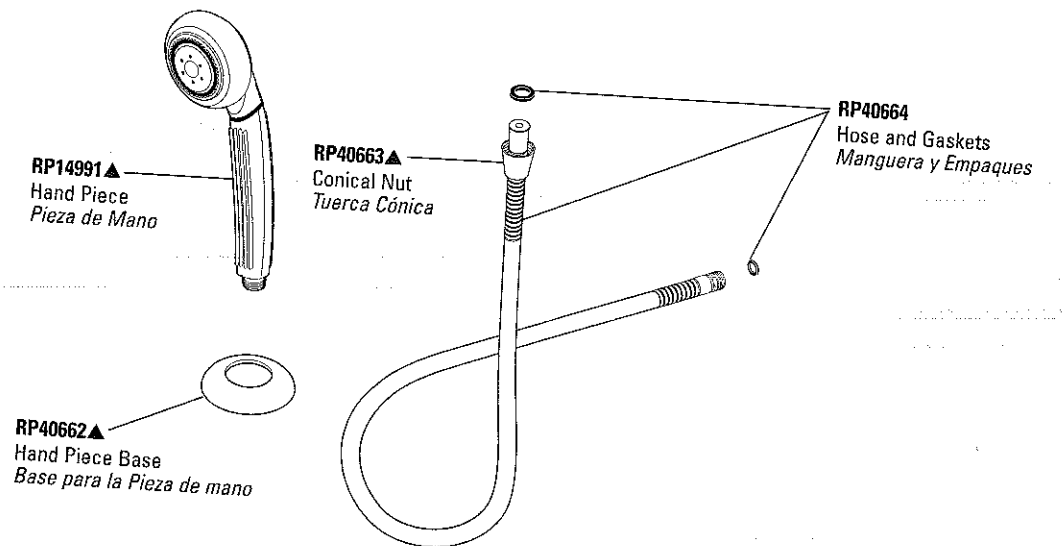
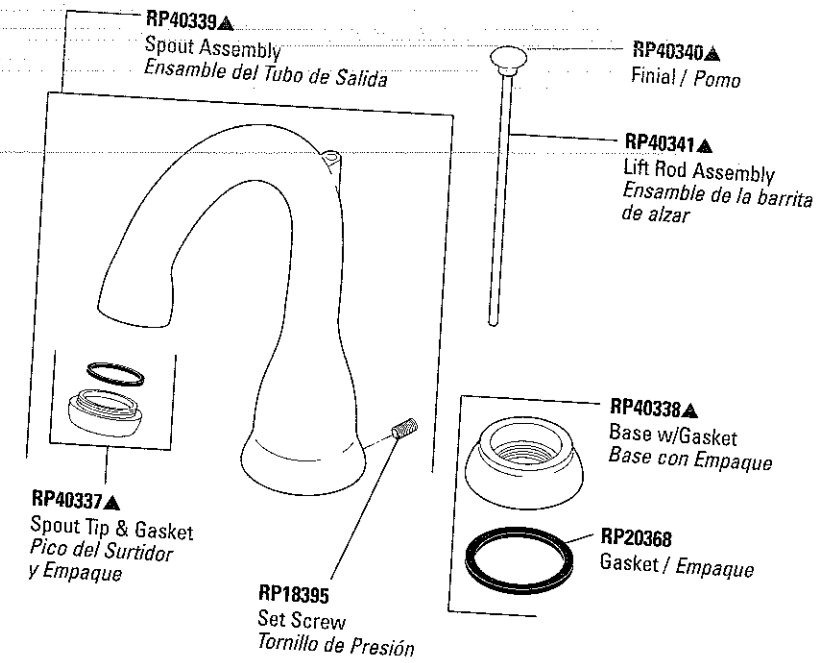

Refer to page 152 for Handles. / Para manijas referirse a la pagina 152.

Refer to pages 144-148 for rough-in kits. / Para Equipo para Preparación de Instalación referirse a las paginas 144-148.

Refer to pages 144-148 for rough-in kits. / Para Equipo para Preparación de Instalación referirse a las paginas 144-148.

ROMAN TUB

ROMAN TUB

Deck/Ledge Mount Rough-In Kit

Montura de Bordes para Equipo para Preparación de Instalación

Model R2707 3-Hole Universal Rough-In Installation Kit

Deck/Ledge Mount Rough-In Kit

Montura de Bordes para Equipo para Preparación de Instalación

Model R4707 4-Hole Universal Rough-In Installation Kit

ROMAN TUB

ROMAN TUB

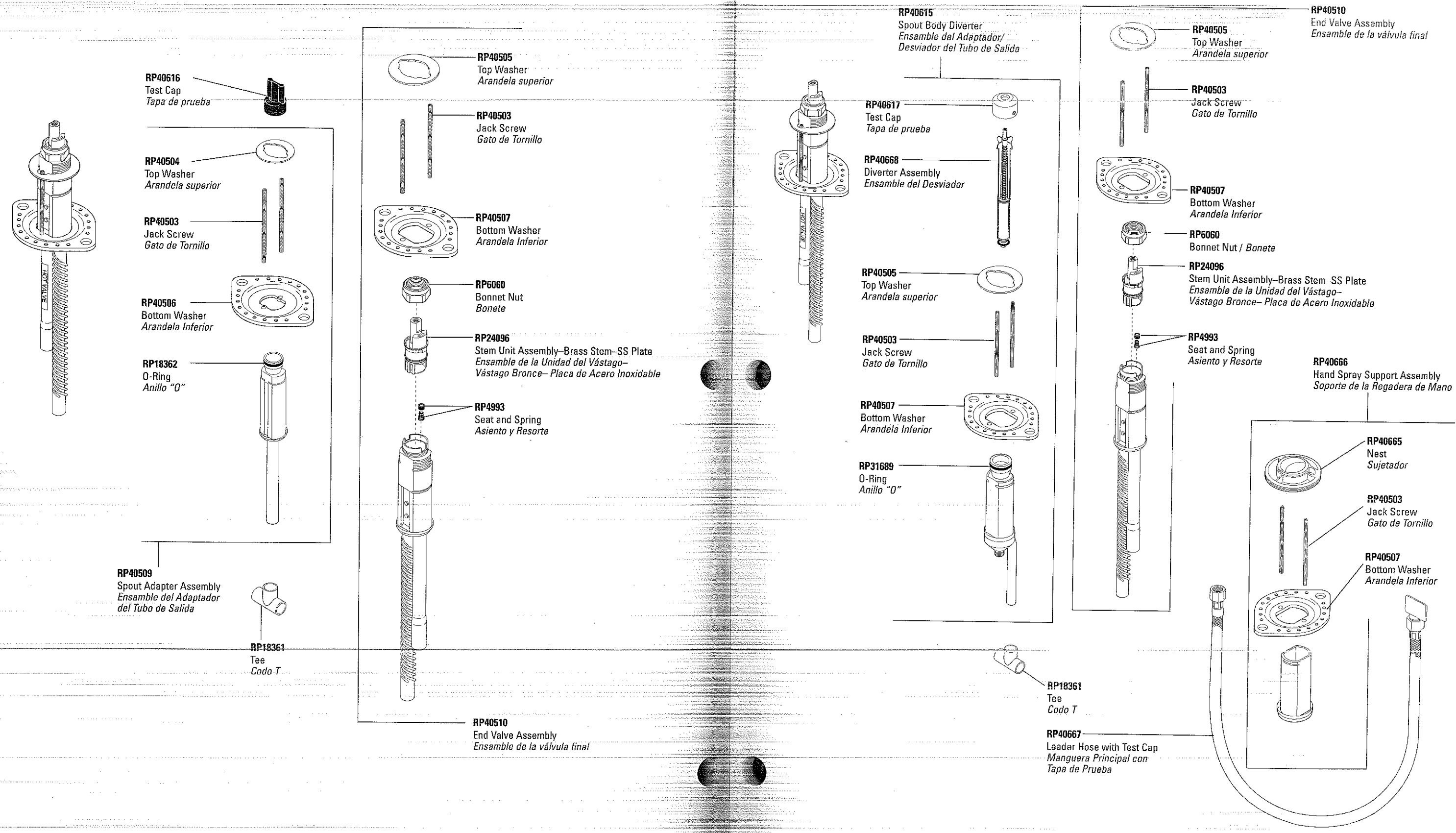

Deck/Ledge Mount Rough-In Kit

Montura de Bordes para Equipo para Preparación de Instalación

Model RP23601 10" Fixed Conventional Rough-In Kit
 Modelo RP23601 Equipo de Preparación para Instalación Fija Convencional de 10"

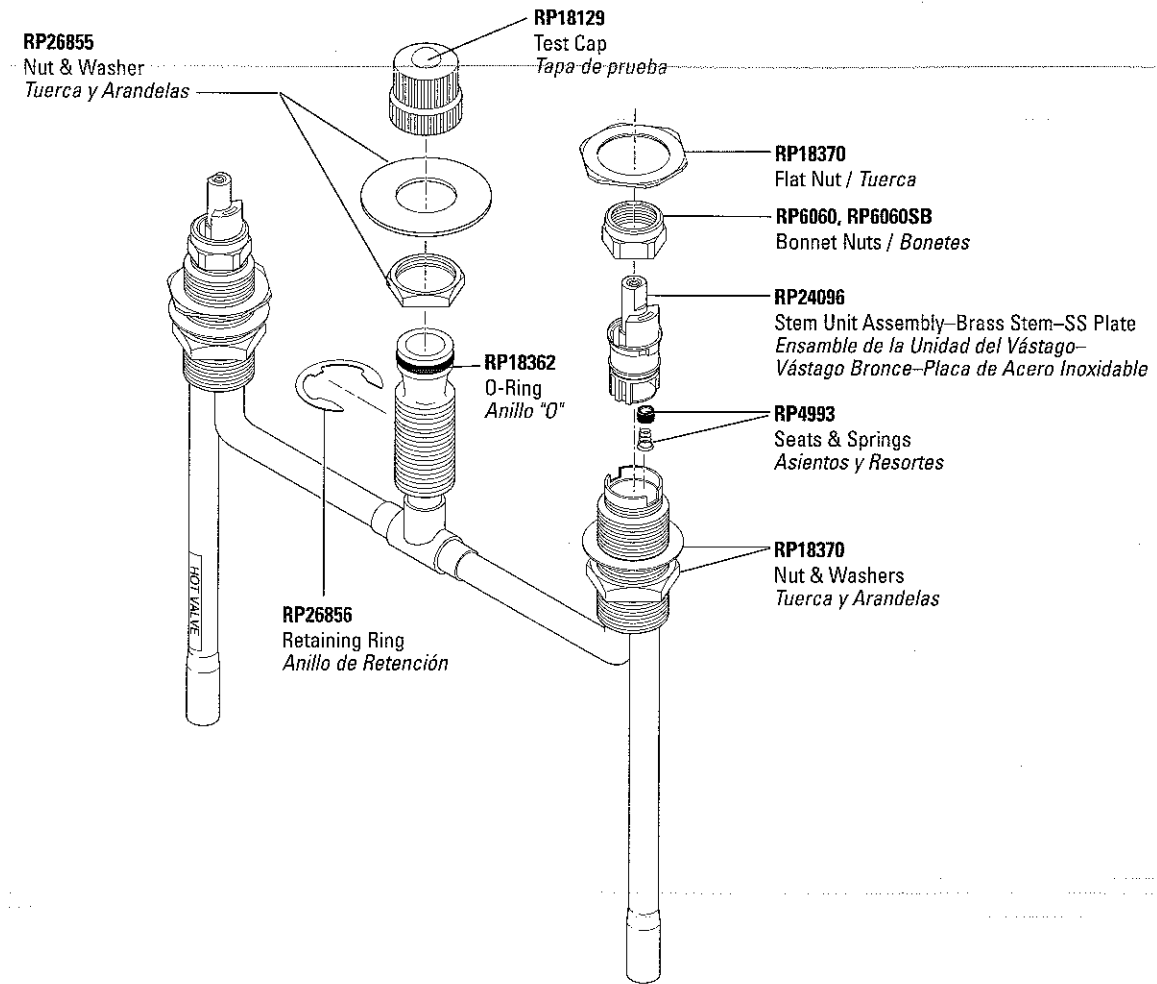

Deck/Ledge Mount Rough-In Kit

Montura de Bordes para Equipo para Preparación de Instalación

Model RP18227 Conventional Rough-In Kit
 Modelo RP18227 Equipo de Preparación para Instalación Convencional

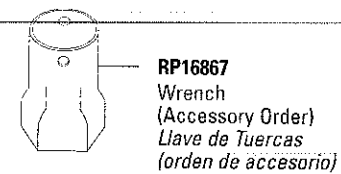
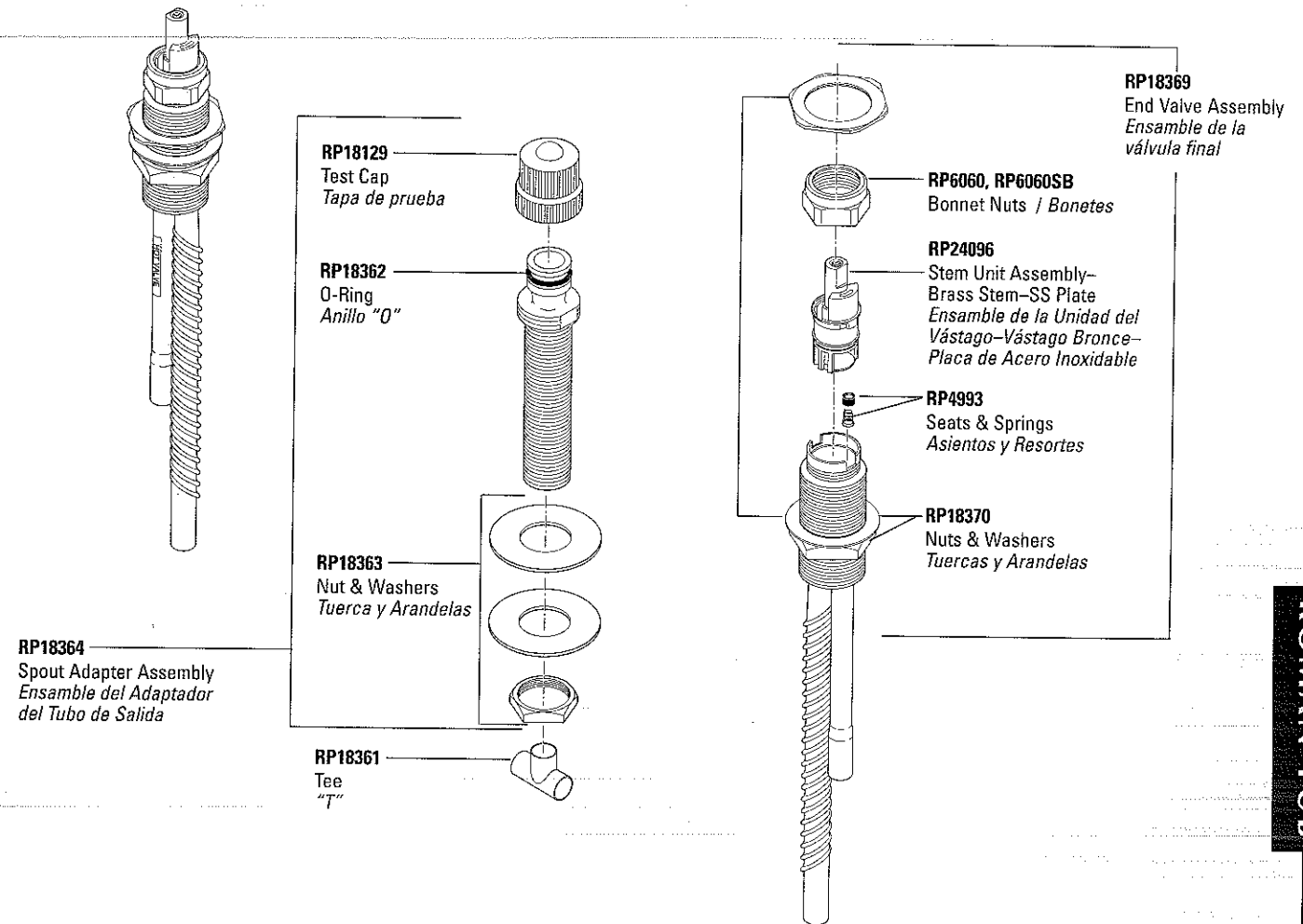

Adjusts to 1 1/4" Max. Deck Thickness / Se Ajusta Hasta un Max. de 1 1/4" de Grosor del Bordo

Adjusts to 1 1/4" Max. Deck Thickness. For 1" Additional Thickness Order RP18504
 Se Ajusta Hasta un Max. de 1 1/4" de Grosor del Bordo. Para Mas Grosor 1" Hago un Pedido RP18504

Deck/Ledge Mount Rough-In Kit

Montura de Bordos para Equipo para Preparación de Instalación

Notes / Notas

Model RP18235 Thick Tile Rough-In Kit
 Modelo RP18235 Equipo de Preparación para Instalación en Losas Gruesas

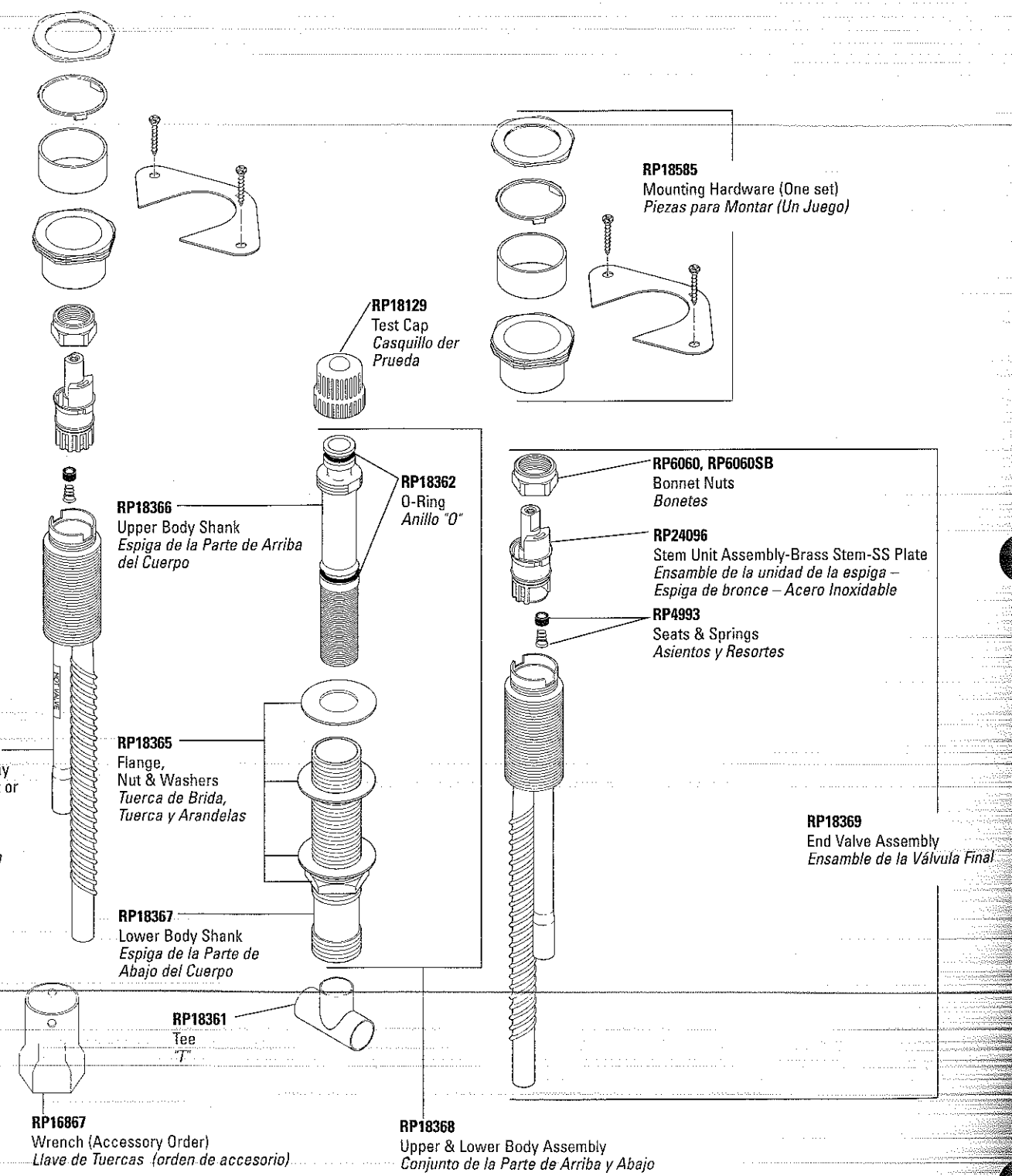

ROMAN TUB

ROMAN TUB

Adjusts to 3 1/4" max deck thickness before mud & tile / Se ajusta hasta un max. de 3 1/4" de grosor del borde antes de la aplicación del lodo y las losas
 RP18504 cannot be used / No puede utilizar el RP18504

Roman Tub Hand Held Showers

Regaderas de Mano para Llaves de Bañeras Romanas

Classic Series Model/Modelo RP14979 Series

Roman Tub Hand Held Showers

Regaderas de Mano para Llaves de Bañeras Romanas

Victorian® Collection Model/Modelo RP33791 Series

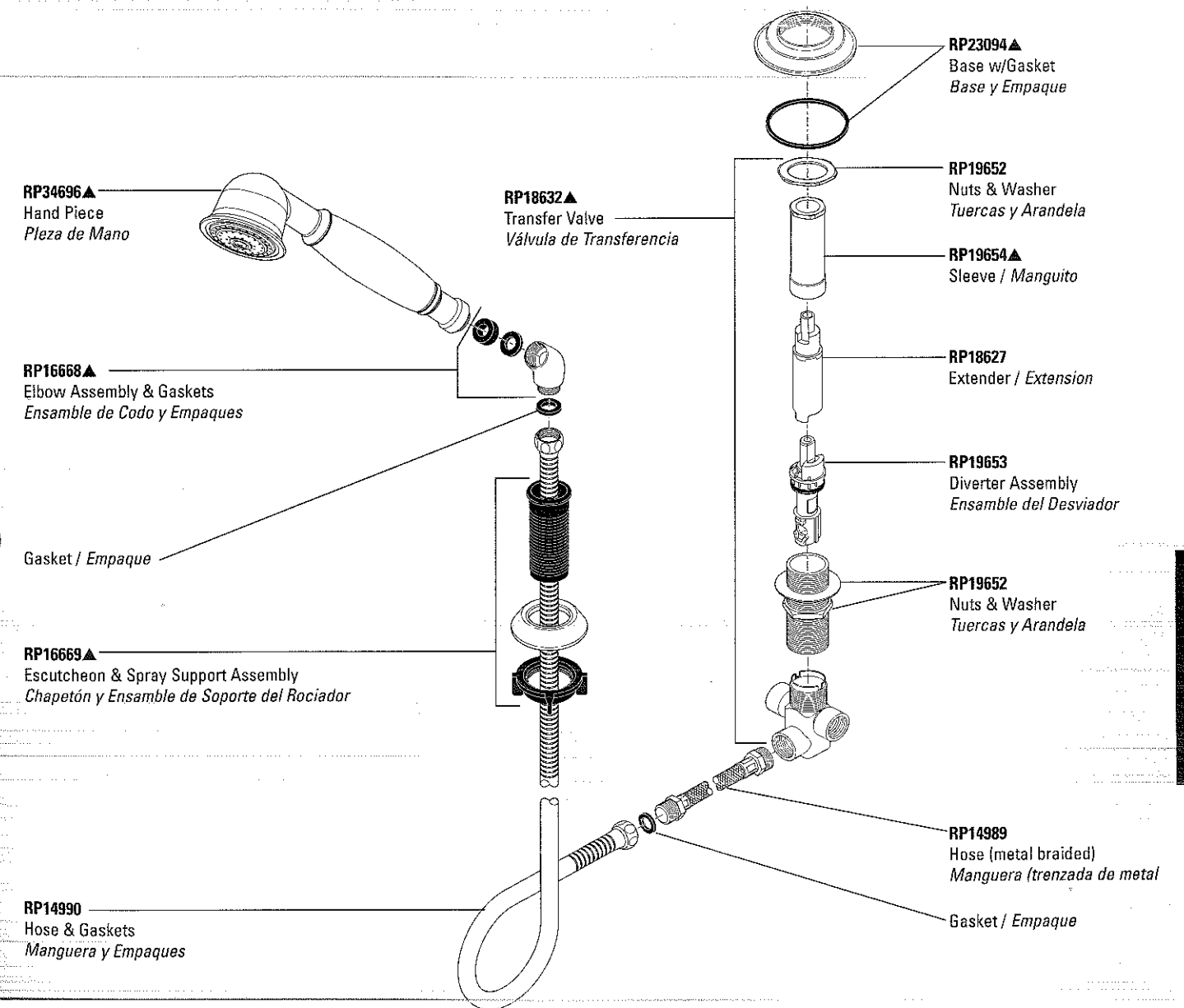
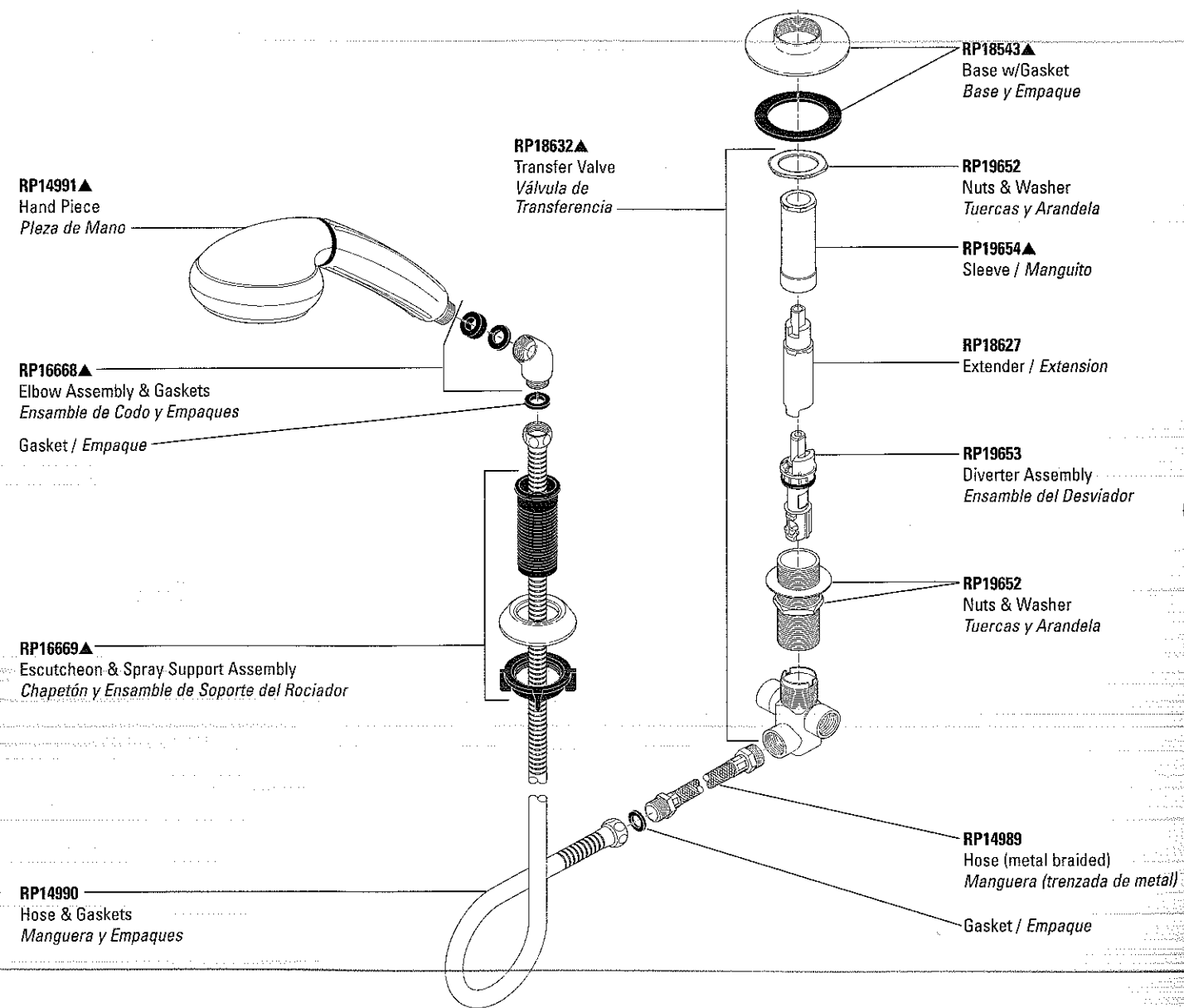

HANDSHOWER

HANDSHOWER

Refer to page 153 for Handles. / Para manijas referirse a la pagina 153.

Refer to page 153 for Handles. / Para manijas referirse a la pagina 153.

Roman Tub Faucet Handles and Accents

Manijas y Accesorios para Llaves de Agua de Bañeras Romanas

Roman Tub Hand-Held Shower Handles and Accents

Manijas y Accesorios para Regaderas Manuales de Bañeras Romanas

H61, H61PB
Clear Knob Handles w/Buttons & Screws
Perillas Transparente con Botones y Tornillos

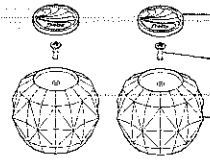

RP18373, RP18373PB
Button Set (Red/Blue Indicators)
Botones (Indicadores: Rojo/Azul)
RP5885
Screws/Tornillos
RP18372
Handle/Manija

H62▲
Standard Lever Handles w/Screws
Manijas Estilo Palancas Estándares con Tornillos

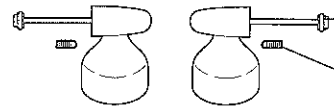

RP26851▲
Spindle/Husillo
RP26865
Set Screws/Tornillos de Ajuste

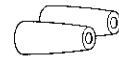

A62▲
Handle Accents
Acentos para Manijas

H64▲
Innovations® Lever Handles w/Screws
Manijas Estilo Palanca Innovations® con Tornillos

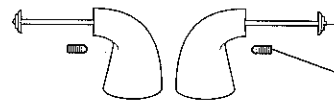

RP26852▲
Spindle/Husillo
RP26865
Set Screws/Tornillos de Ajuste

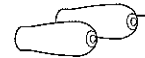

A64▲
Handle Accents
Acentos para Manijas

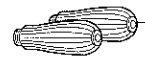

A64CL
Clear Accents
Acentos de Transparente

H65▲
Neo Style® Lever Handles w/Screws
Manijas Estilo Palanca Neo Style® con Tornillos

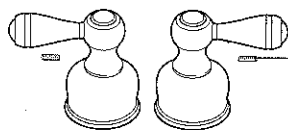

RP26865
Set Screws/Tornillos de Ajuste

H66▲
Neo Style® Metal Cross Handles w/Screws
Manijas de Metal en Forma de Cruz Neo Style® con Tornillos

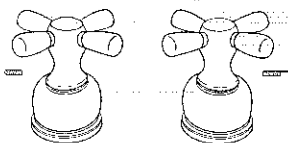

RP26865
Set Screws/Tornillos de Ajuste

H67▲
Neo Style® Porcelain Cross Handles w/Screws
Manijas de Porcelana en Forma de Cruz Neo Style® con Tornillos

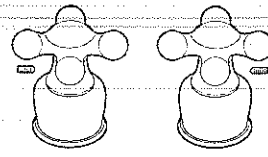

RP26865
Set Screws/Tornillos de Ajuste

H612▲
Traditional Porcelain Lever Handles w/Screws
Manijas Tradicionales Estilo Palanca de Porcelana con Tornillos

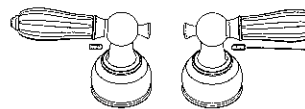

RP26865
Set Screws/Tornillos de Ajuste

H615▲
Traditional Metal Lever Handles w/Screws
Manijas Tradicionales Estilo Palanca de Metal con Tornillos

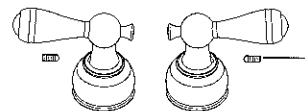

RP26865
Set Screws/Tornillos de Ajuste

H616▲
Victorian™ Lever Handles w/Screws
Manijas Estilo Palanca Victorian™ con Tornillos

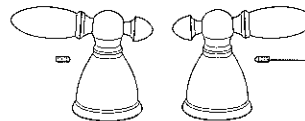

RP26865
Set Screws/Tornillos de Ajuste

H617▲
Botanical™ Lever Handles w/Screws
Manijas Estilo Palanca Botanical™ con Tornillos

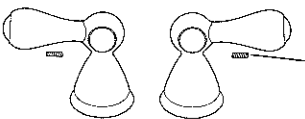

RP26865
Set Screws/Tornillos de Ajuste

RP39378
Interchangeable handle accents:
red, blue, orange, green, and white.
White has "H" and "C" indicators.
Accesorios Intercambiables
para Manijas

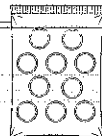

H51, H51PB
Clear Knob Handle w/Button & Screw
Perilla Transparente con Botón y Tornillo

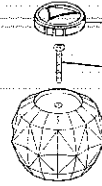

RP18429, RP18429PB
Button-Arrow
Botón-Flecha
RP18678
Screw/Tornillo
RP18372
Handle/Manija

H52▲
Standard Lever Handle w/Screw
Manija Estilo Palanca Estándar con Tornillo

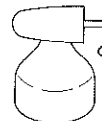

RP26851▲
Spindle/Husillo
RP26865
Set Screw/Tornillo de Ajuste



A72▲
Handle Accent
Acento para Manija

H54▲
Innovations® Lever Handle w/Screw
Manija Estilo Palanca Innovations® con Tornillo



RP26852▲
Spindle/Husillo
RP26865
Set Screw/Tornillo de Ajuste

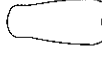

A74▲
Handle Accent
Acento para Manija



A74CL
Clear Accent
Acento de Transparente

H55▲
Neo Style® Lever Handle w/Screw
Manija Estilo Palanca Neo Style® con Tornillo

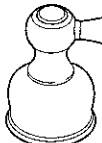

RP26865
Set Screw/Tornillo de Ajuste

H56▲
Neo Style® Metal Cross Handle w/Screw
Manija de Metal en Forma de Cruz Neo Style® con Tornillo

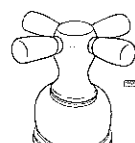

RP26865
Set Screw/Tornillo de Ajuste

H57▲
Neo Style® Porcelain Cross Handle w/Screw
Manija de Porcelana en Forma de Cruz Neo Style® con Tornillo

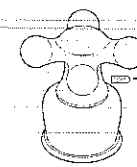

RP26865
Set Screw/Tornillo de Ajuste

H512▲
Traditional Porcelain Lever Handle w/Screw
Manija Tradicional Estilo Palanca de Porcelana con Tornillo

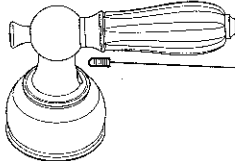

RP26865
Set Screw/Tornillo de Ajuste

H515▲
Traditional Metal Lever Handle w/Screw
Manija Tradicional Estilo Palanca de Metal con Tornillo

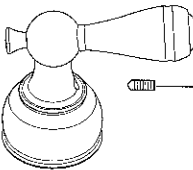

RP26865
Set Screw/Tornillo de Ajuste

H516▲
Victorian™ Lever Handle w/Screw
Manija Estilo Palanca Victorian™ con Tornillo

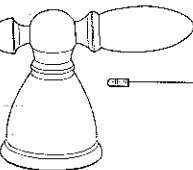

RP26865
Set Screw/Tornillo de Ajuste

H517▲
Botanical™ Lever Handle w/Screw
Manija Estilo Palanca Botanical™ con Tornillo

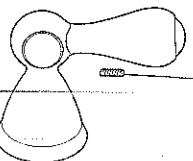

RP26865
Set Screw/Tornillo de Ajuste

RP39379
Interchangeable handle accents:
red, blue, orange, green, and white.
White has "H" and "C" indicators.
Accesorios Intercambiables
para Manijas

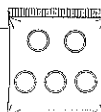

Installation Aids/Repair Kits

Herramientas para la Instalación/Herramientas de Repuesto

Notes / Notas

RP22132
Helpful Hand Installation Aid
Utensilio para Asistencia en Instalaciones a Mano



RP27972
Thick deck installation aid for conventional installation kit

Herramientas para la Instalación

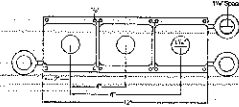

RP18504
Thick Tile Mounting Kit-Roman Tub Deck Conv. Installation Kit-Adds 1" to End Valves

Herramientas para Monturas en Losa Gruesa-Preparación de Instalación Convencional para Montura de Bordos de Bañeras Romanas-Válvulas Final para Más 1"

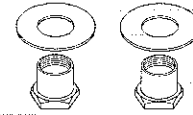

RP18300▲
2 1/2" Base w/Gasket
Base de 2 1/2" con Empaque

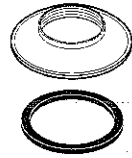

RP1740
Stem Unit Assembly
Ensamble Unidad-Espiga, 2H-Placa de Acero Inoxidable

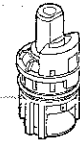

RP23094▲
2 5/8" Base w/Gasket
Base de 2 5/8" con Empaque

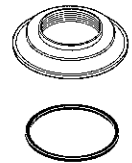

RP16867
End Valve Adjusting Wrench-RT
Llave de Tuercas Ajustadora para la Válvula Final-RT

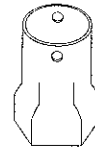

RP8230
Ceramic Stem Unit, Seat, O-Ring & Spring

Unidad de la Espiga de Cerámica, Asiento, Anillo "O" y Resorte



RP18543▲
3" Base w/Gasket
Base de 3" con Empaque

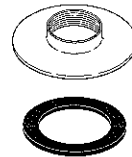

RP10700
Ceramic Seats, O-Rings & Springs
Asientos de Cerámica, Anillos "O" y Resortes



ROMAN TUB

ROMAN TUB

Bath Wastes-Trip Lever

Desagüe de la Bañera-Palanquita de Desenganche

Model/Modelo RP291 Series (20 ga. Brass / Bronce de 20 calibres)
 Model/Modelo RP691 Series (17 ga. Brass / Bronce de 17 calibres)

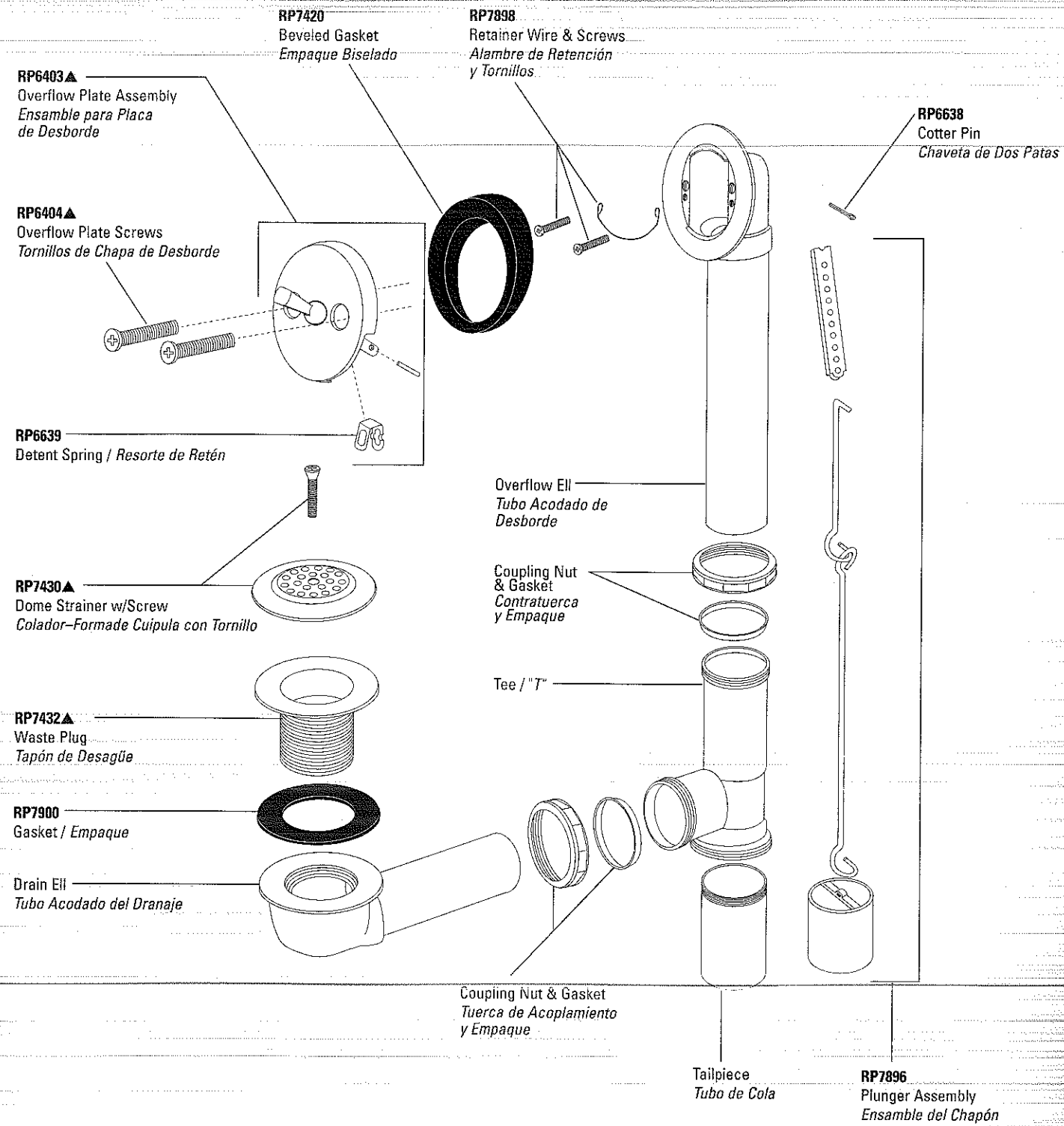

Bath Wastes-Lift-N-Turn

Desagüe de la Bañera-Alce y Gire

Model/Modelo RP695* Series (17 ga. Brass / Bronce de 17 calibres)

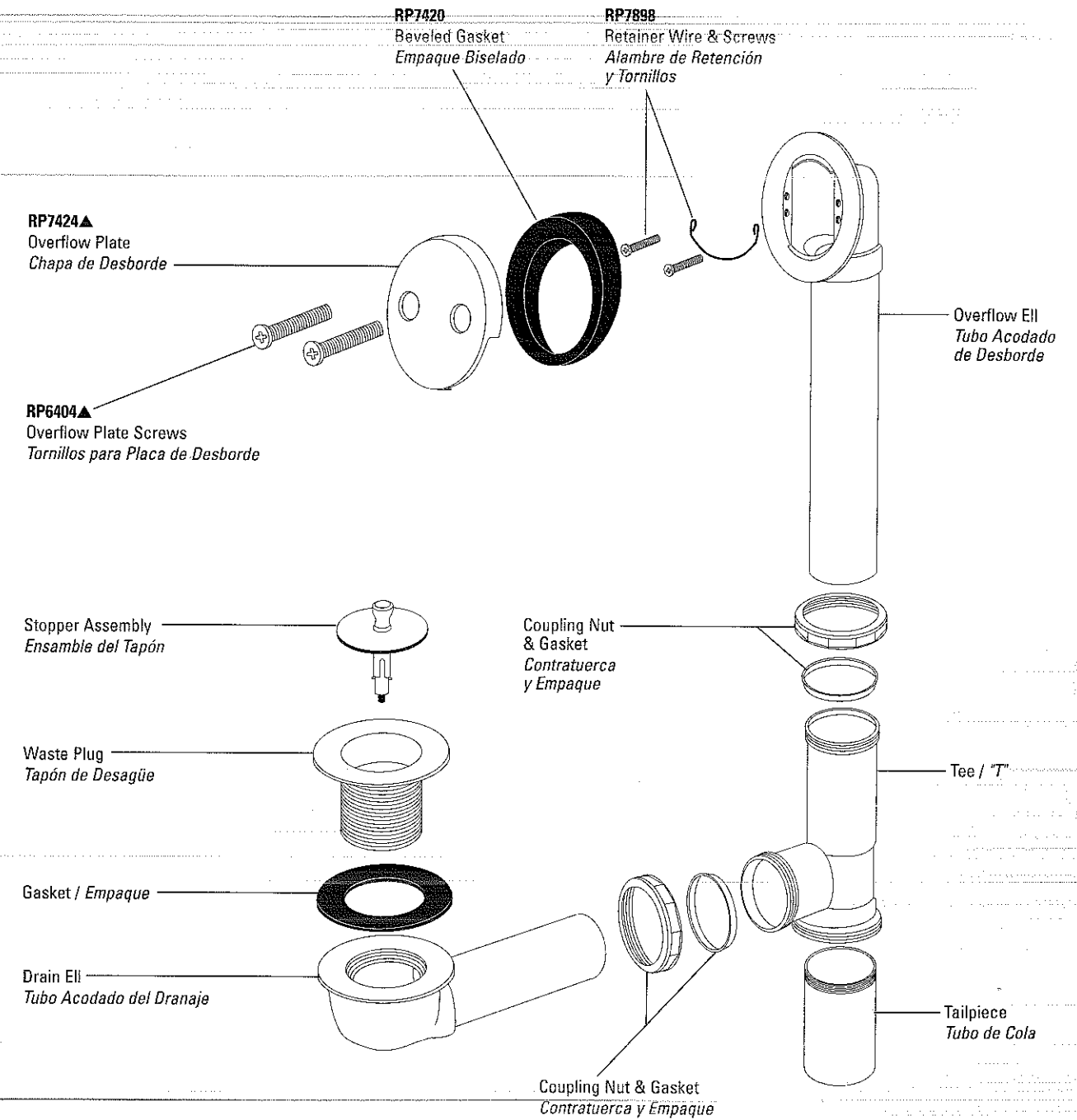

BATH WASTES

BATH WASTES

Bath Wastes—Trip Lever Desagüe de la Bañera—Palanquita de Desenganche

Model/Modelo RP391 Series (Polypropylene / Polipropileno)

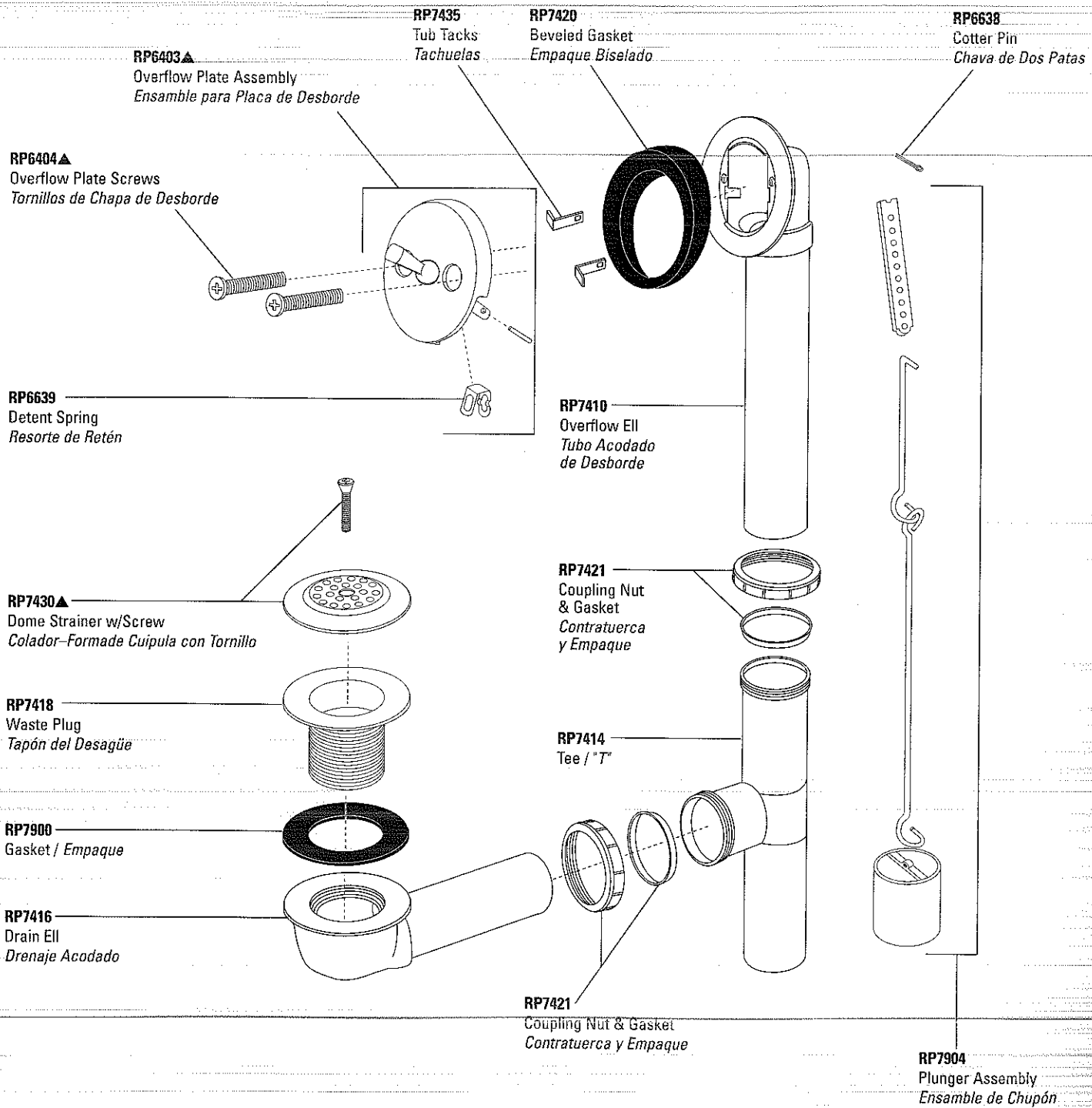

Bath Wastes—Toe Operated Desagüe de la Bañera—Operado con el Pie

Model/Modelo RP393 Series (Polypropylene / Polipropileno)

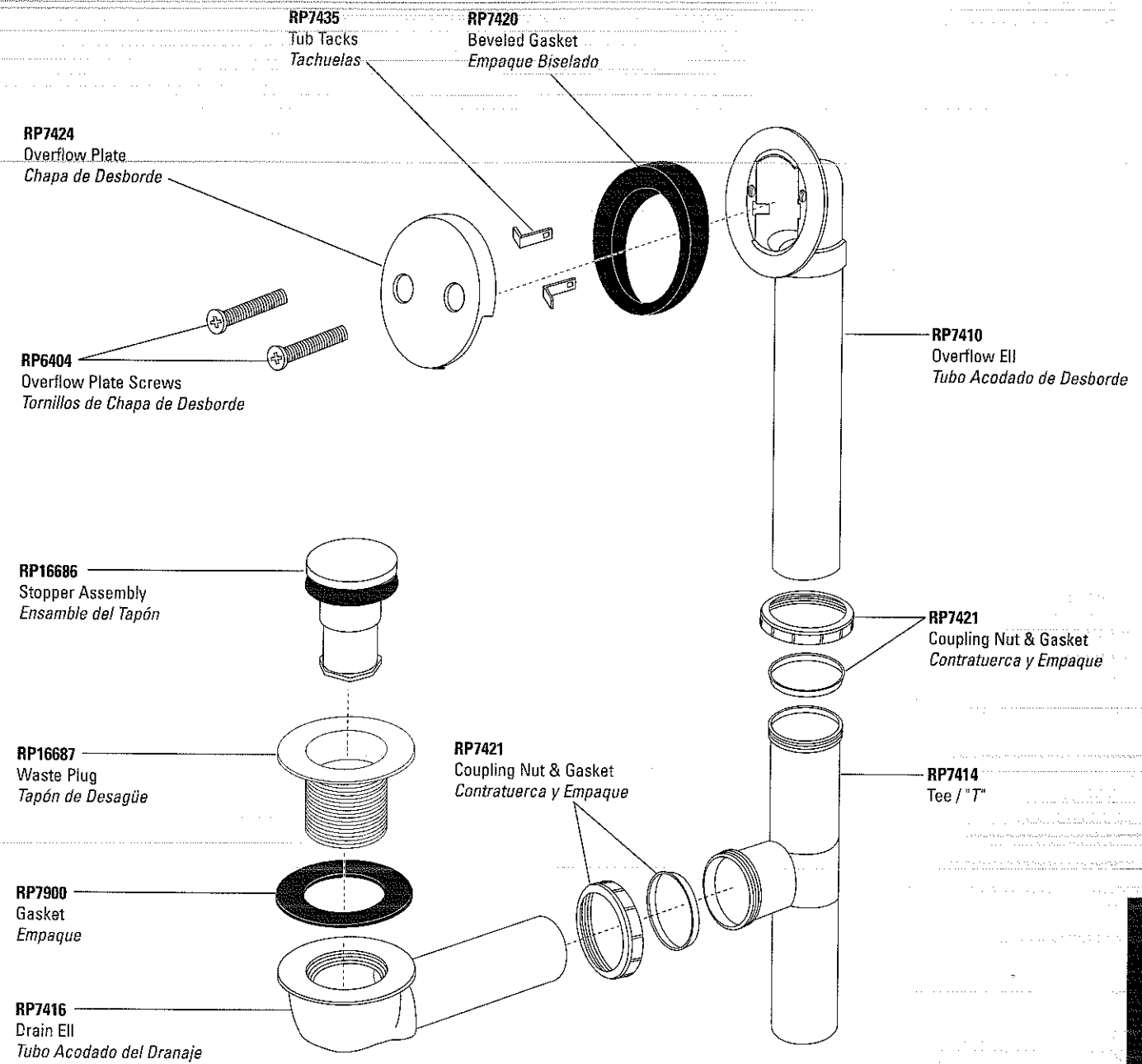

Bath Wastes—Toe Operated

Desagüe de la Bañera—Operado con el Pie

Model/Modelo RP293 Series (20 ga. Brass / *Bronce de 20 calibres*)
 Model/Modelo RP693 Series (17 ga. Brass / *Bronce de 17 calibres*)

Notes / Notas

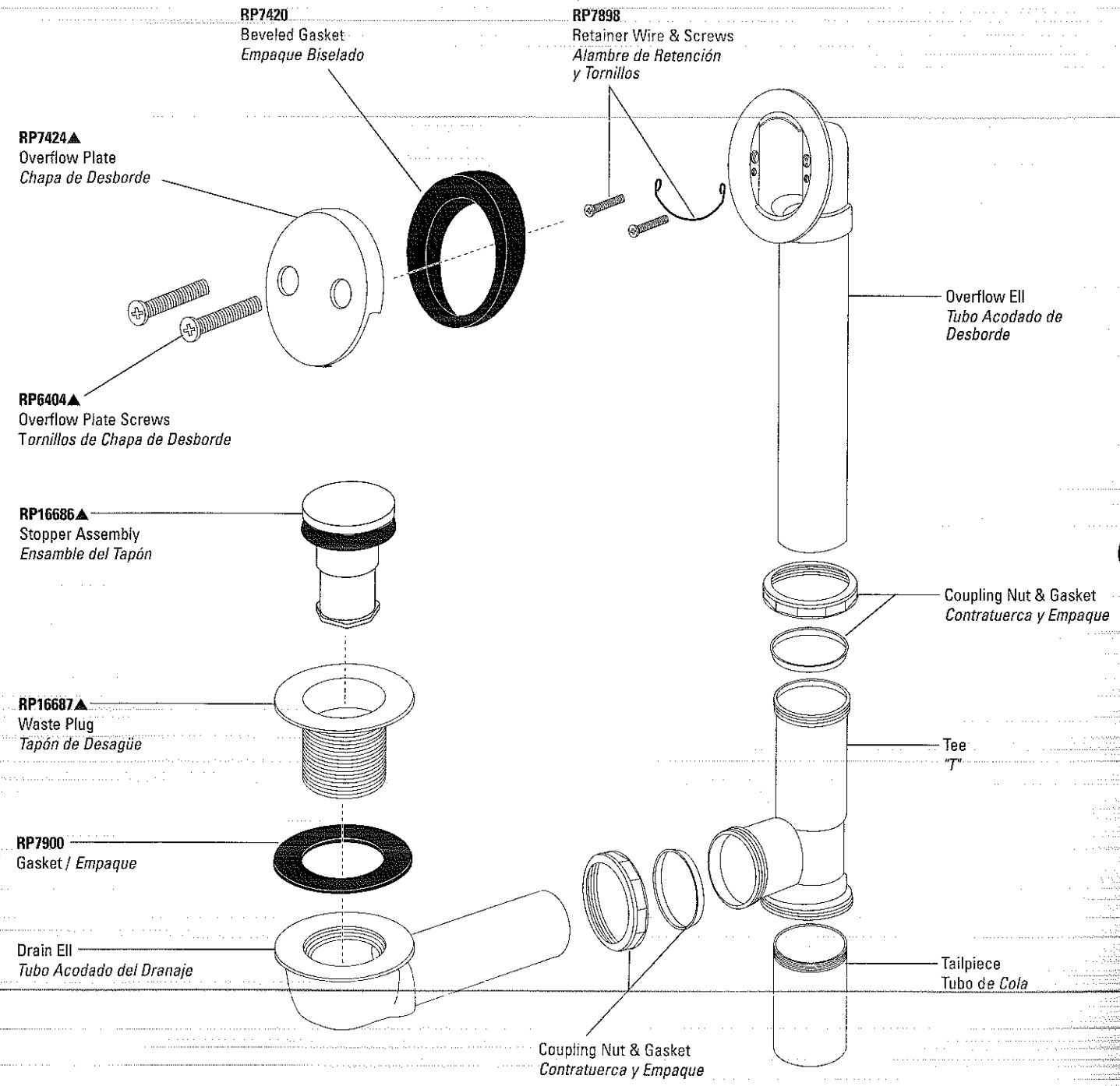

BATH WASTES

BATH WASTES

Bidet Valves

Válvulas para Bidés

Classic Series Model/Modelo 33 Series

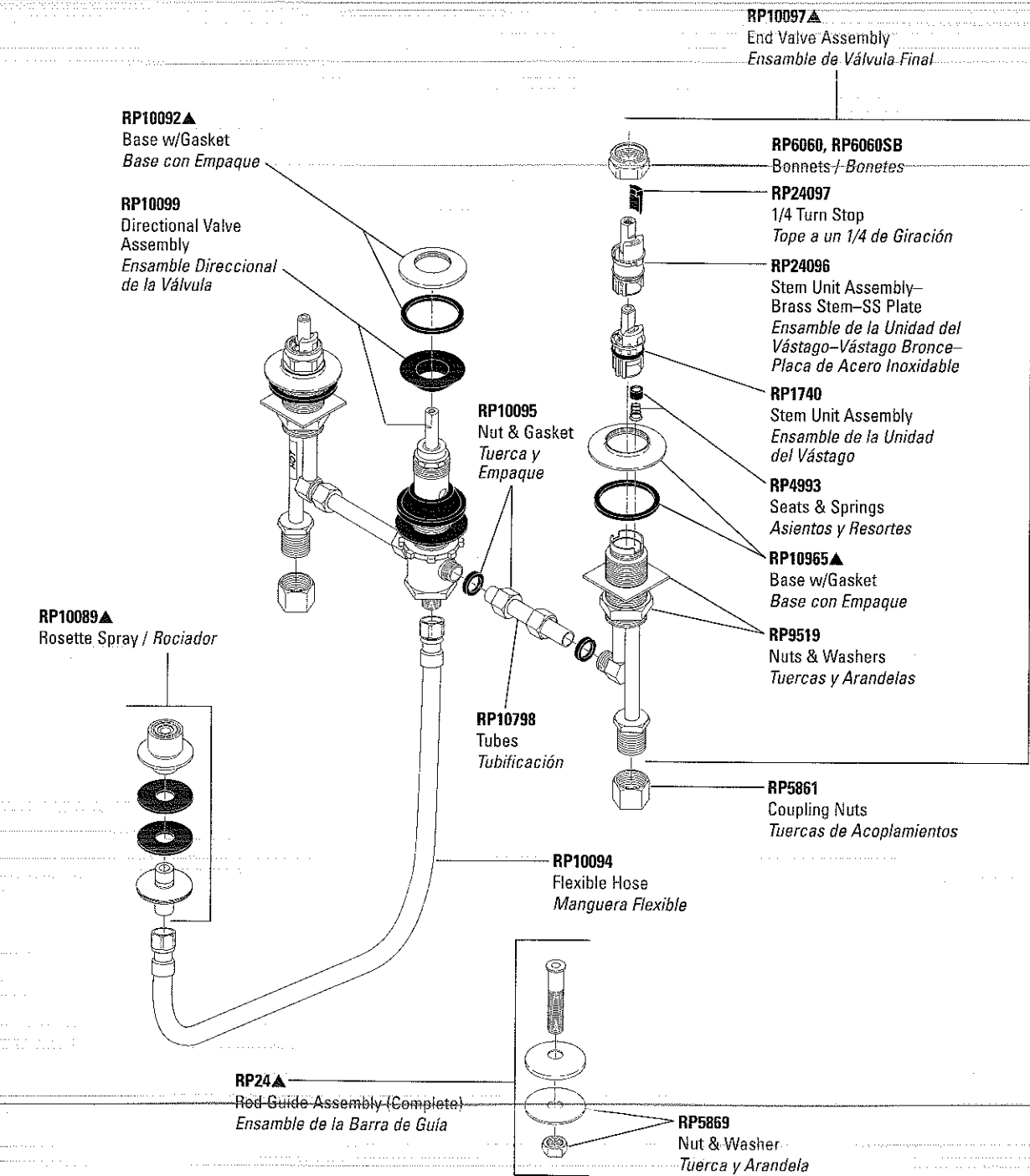

Bidet Valves

Válvulas para Bidés

Classic Series Model/Modelo 44 Series

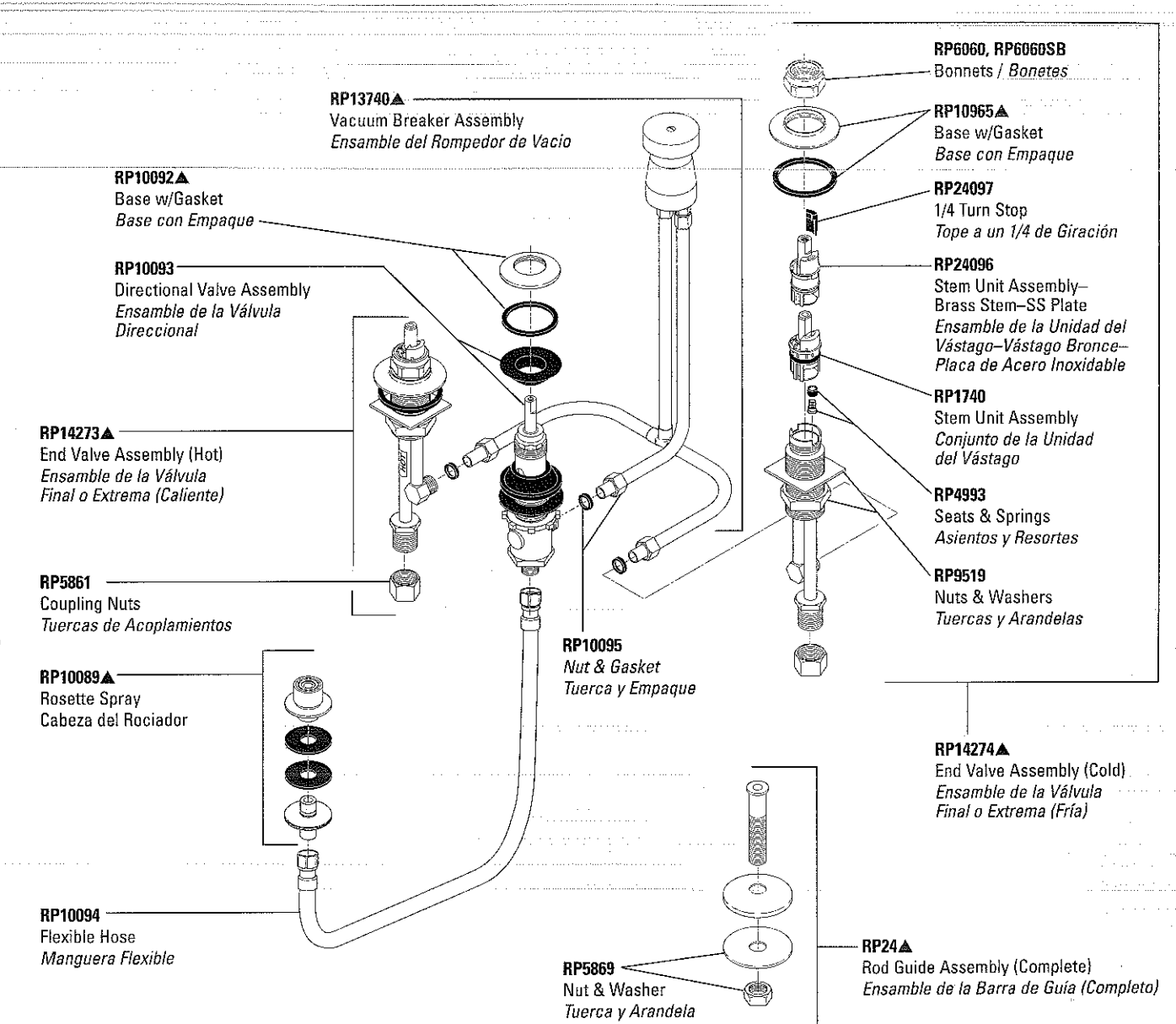

Refer to page 164 for Handles. / Para manijas referirse a la pagina 164.

Refer to pages 98-101 for lift rod and drain assemblies. / Para ensamble de drenaje y barras de alzar referirse a las paginas 98-101.

Refer to page 164 for Handles. / Para manijas referirse a la pagina 164.

Refer to pages 98-101 for lift rod and drain assemblies. / Para ensamble de drenaje y barras de alzar referirse a las paginas 98-101.

Direct Valve Handles & Accents Manijas de Válvulas y Accesorios para Bidés

Notes / Notas

Diverter Handles - Use for all knob, cross & lever handles.
Manijas para Desviadores - Le sirven a todas las manijas de Perilla, cruz y palanca.

H11, H11PB
Clear Knob Handle w/Button & Screw
Perilla Transparente con Botón y Tornillo

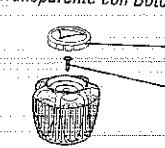

RP18429
Button-Arrow/Botón-Flecha

RP5885
Screw/Tornillo

H31, H31PB
Clear Knob Handle w/Button & Screw
Perilla Transparente con Botón y Tornillo

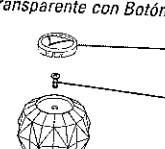

RP18429
Button-Arrow/Botón-Flecha

RP5885
Screw/Tornillo

H36▲
Neo Style® Metal Cross Handle w/Screw
Manija de Metal en Forma de Cruz Neo Style® con Tornillo

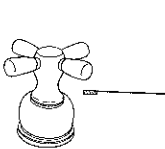

RP25620
Set Screw/Tornillo de Ajuste

H17▲
Neo Style® Porcelain Cross Handle w/Screw
Manija de Porcelana en Forma de Cruz Neo Style® con Tornillo

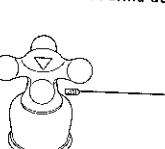

RP25620
Set Screw/Tornillo de Ajuste

H22▲
Standard Lever Handles w/Screws / Manijas Estilo Palancas Estándares con Tornillos

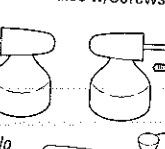

RP25620
Set Screws/Tornillos de Ajuste

RP26851▲
Spindle/Husillo

RP27644
Finial/Botón para la Barra del Desagüe

A22▲
Handle Accents / Acentos para Manijas

H24▲
Innovations® Lever Handles w/Screws / Manijas de Palanca con Tornillos-Innovations®

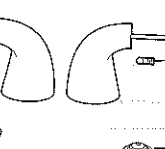

RP25620
Set Screws/Tornillos de Ajuste

RP26852▲
Spindle/Husillo

RP34410
Finial/Botón para la Barra del Desagüe

A24▲
Handle Accents / Acentos para Manijas

A24CL
Clear Accents / Acentos de Transparente

H25▲
Neo Style® Lever Handles w/Screws / Manijas de Palanca con Tornillos-Neo Style®

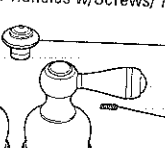

RP34410▲
Finial/Botón para la Barra del Desagüe

RP25620
Set Screws/Tornillos de Ajuste

H21, H21PB
Clear Knob Handles w/Buttons & Screws
Perillas Transparente con Botones y Tornillos

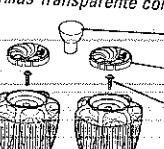

RP27644▲
Finial/Botón para la Barra del Desagüe

RP18373, RP18373PB
Button Set (Red/Blue Indicators)
Botones (Indicadores: Rojo/Azul)

RP5885
Screws/Tornillos

H41, H41PB
Clear Knob Handles w/Buttons & Screws
Perillas Transparente con Botones y Tornillos

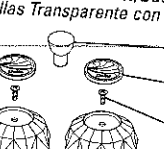

RP27644▲
Finial/Botón para la Barra del Desagüe

RP18373, RP18373PB
Button Set (Red/Blue Indicators)
Botones (Indicadores: Rojo/Azul)

RP5885
Screws/Tornillos

H26▲
Neo Style® Metal Cross Handles w/Screws
Manijas de Metal en Forma de Cruz Neo Style® con Tornillos

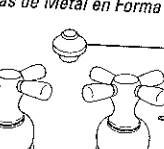

RP24588▲
Finial/Botón para la Barra del Desagüe

RP25620
Set Screws/Tornillos de Ajuste

H27▲
Neo Style® Porcelain Cross Handles w/Screws
Manijas de Porcelana en Forma de Cruz Neo Style® con Tornillos

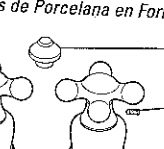

RP24588▲
Finial/Botón para la Barra del Desagüe

RP25620
Set Screws/Tornillos de Ajuste

H212▲
Traditional Porcelain Lever Handles w/Screws
Manijas Tradicionales Estilo Palanca de Porcelana con Tornillos

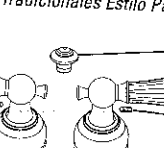

RP34410▲
Finial/Botón para la Barra del Desagüe

RP25620
Set Screws/Tornillos de Ajuste

H215▲
Traditional Metal Lever Handles w/Screws
Manijas Tradicionales Estilo Palanca de Metal con Tornillos

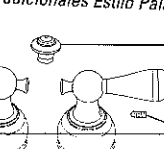

RP34410▲
Finial/Botón para la Barra del Desagüe

RP25620
Set Screws/Tornillos de Ajuste

H216▲
Victorian™ Lever Handles w/Screws
Manijas Estilo Palanca Victorian™ con Tornillos

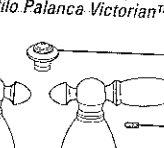

RP34410▲
Finial/Botón para la Barra del Desagüe

RP25620
Set Screws/Tornillos de Ajuste

BIDET VALVE HANDLES

BIDET VALVES

Miscellaneous Parts / Piezas Misceláneas

Miscellaneous Parts / Piezas Misceláneas

MISCELLANEOUS PARTS

MISCELLANEOUS PARTS

RP25
RP25MBS (120 per case/120 por caja)
 O-Rings-Spout-1H Kitchen
 Anillos "O"-Tubo de Salida-1H Cocina

RP50▲
 Cap w/Adj. Ring-Single Handle
 Tapa con Anillo Ajustable-
 Manija Sencilla

RP61
RP61MBS (60 per case/60 por caja)
 Cam & Packing - Single Lever Handle
 Leva y Empaque - Manija de
 Palanca Sencilla

RP70
RP70MBS (60 per case/60 por caja)
 Ball Assembly - Single Lever Handle-SS
 Ensamble de la Bola - Manija-Palanca
 Sencilla - Acero Inoxidable

RP76
 Pipe Plug-1/2" IPS-T/S
 Tapón de Tubería-1/2" IPS-T/S

RP90
 Handle w/Set Screw
 Manija con Tornillo de Ajuste

RP116
 Plasterguard/Thin Wall Mounting
 Bracket-600/1600
 Protector de Enlucido/Soporte para
 Montura en Pared Delgada-600/1600

RP152▲
 Set Screw-Single Lever Handle -
 1/4-28x5/16" (uses 1/8" allen wrench)
 Tornillo de Ajuste-Manija-Palanca
 Sencilla-1/4-28 (Usa Llave Allen 1/8")

RP188
RP188MBS (60 per case/60 por caja)
 Cam & Packing - Single Knob Handle
 Leva y Empaque - Perilla Sencilla

RP196▲
 Screws-1H T/S Escutcheon -
 2 3/4" x 10-24
 Tornillos-1H T/S Chapetón -
 2 3/4" x 10-24

RP212
RP212MBS (60 per case/60 por caja)
 Ball Assembly - Single Knob Handle-SS
 Ensamble de la Bola-Manija -Palanca
 Sencilla - Acero Inoxidable

RP246
 Aerator w/Wrench-VR - 15/16"-27
 Male Thread - 2.0 gpm @ 80 psi
 Aireador con Llave de Tuerca-
 Resistente al Maltrato-15/16"-27
 Rosca Macho - 7.6L/Min @ 551 kPa

RP250
RP250MBS (60 per case/60 por caja)
 Adjusting Ring-Single Handle
 Anillo de Ajuste-Manija Sencilla

RP320
RP320MBS (60 per case/60 por caja)
 Diverter Assembly-1H Kitchen w/Spray
 Ensamble del Desviador-1H Cocina
 con Rociador

RP330▲
RP330MBS (60 per case/60 por caja)
 Aerator - 15/16"-27 Male Thread -
 2.0 gpm @ 80psi
 Aireador - 15/16"-27 Rosca Macho -
 7.6L/Min @ 551 kPa

RP334
 Gasket (Black) - 1H Kitchen
 Empaque (Negro) - 1H Cocina

RP574
 Pressure Balance Assembly - 600/1600
 Ensamble de Balance de Presión-
 600/1600

RP691▲
 Trip Lever Bath Waste Assembly - Brass
 Ensamble del Desagüe/Bañera/
 Operado con Palanquita de
 Desenganche - Bronce

RP693▲
 Toe-Operated Bath
 Waste Assembly-Brass
 Ensamble del Desagüe/Bañera/
 Operado con Pie-Bronce

RP1001▲
 Soap/Lotion Dispenser Assembly
 Ensamble del Surtidor de
 Jabón/Loción

RP1129
 O-Ring - Spout - NEO STYLE™,
 Waterfall® Kitchen
 Anillo "O"-Tubo de Salida -
 NEO STYLE™, Waterfall® Cocina

RP1740
RP1740MBS (60 per case/60 por caja)
 Stem Unit Assembly - 2H-SS Plate
 Ensamble Unidad-Espiga, 2H - Placa
 de Acero Inoxidable

RP1745
 O-Ring for Tub Spout Adapter
 Anillo "O" para Adaptador del
 Tubo de Salida

RP1806
RP1806MBS (240 seats per case/
 240 asientos por caja)
 Seats / Asientos

RP1974
 Wrench - 1/8" Allen — For Lever
 Handle Set Screw/All Adjusting Rings
 Llave de Turcas Allen — 1/8" para
 Tornillo de Ajuste-Palanca/Todos los
 Anillos de Ajuste

RP1991
RP1991MBS (12 per case/12 por caja)
 Stem Unit Assembly w/Seats - 1600
 Ensamble de la Unidad-Espiga
 con Asientos - 1600

RP2055
 O-Rings - Spout-2H Kitchen
 Anillos "O"-Tubo de Salida-2H Cocina

RP2090
 Screwdriver/Check Stop
 Assembly - 600/1600 Pressure Balance
 Destornillador/Ensamble del Tope -
 Series 600/1600 Presión Balanceada

RP2189
 Spray "Round Swivel Aerator - Fits
 15/16"-27 Male Thread or 55/64"-27
 Female Thread - 2.0 gpm @ 80 psi
 Rociador-Aireador Giratorio Redondo -
 para 15/16"-27 Rosca Macho o
 para 55/64"-27 Rosca Hembra -
 7.6L/Min @ 551 kPa

RP2389
 Handle w/Button & Screw -
 Clear-1H Knob-Lav
 Manija con Botón y Tornillo-
 Transparente-1H Perilla-Lav

RP2390
 Handle - Clear - 2H Knob
 Manija - Transparente - 2H Perilla

RP2391
 Handle w/Button & Screw -
 Clear-1H Knob-600
 Manija con Botón y Tornillo-
 Transparente-1H Perilla-600

RP2392
 Handle w/Button & Screw - Clear
 Manija con Botón y Tornillo -
 Transparente

RP2393▲
 Lever Handle w/Set Screw-1H Kitchen
 Palanca con Tornillos de Ajuste-
 1H Cocina

RP2411
 Button-Clear-1H Knob-Red/Blue-
 Gold Insert-1 3/8" dia.
 Botón-Transparente-1H Perilla-Roja/
 Azul-Dorada-Inserción Dorada-1 3/8" dia.

RP2412
 Button Set-Clear-2H Blade-3/16" dia.
 Botones-Transparente-
 2H Aleta - 3/16" dia.

RP2932
 Boxed Assortment Maintenance
 Parts Kit (5-RP61, 2-RP188,
 2-RP250, 12-RP4993 plus 24 extra
 seats, RP1974, 2-RP212, 2-RP70,
 4-RP320, 6-RP25)
 Piezas Surtidas de Mantenimiento en Caja
 (5-RP61, 2-RP188, 2-RP250, 12-RP4993 Más
 24 Asientos Extras, 1-RP1974, 2-RP212,
 2-RP70, 4-RP320, 6-RP25)

RP3427
RP3427MBS
 (240 springs per case
 240 Resortes por caja)
 Springs / Resortes

RP3614
 Cam Assemblies, O-Rings,
 Seats, Springs, Wrench -
 1H Lever-or-Knob
 Ensamble de la Leva, Anillos
 "O", Asientos, Resortes, Llave
 de Tuercas-1H Palanca o Perilla

RP3816
 3" Diameter Hole Cover
 Cubridor de Huevo de 3" Dia.

RP4039
 Seats & Springs Boxed Kit (48)
 Asientos y Resortes - Juego de
 herramientas en caja (48)

RP4993
 Seats & Springs
 Asientos y Resortes

RP5648▲
 Stopper-Lavatory Drain Assembly
 Tapón-Ensamble del Drenaje
 de Lavamanos

RP5649▲
 Push Button Diverter Assembly -
 7/8" Nut - 13/16"-20 -1H T/S
 Desviador de Botón de Presión -
 7/8" Tuerca - 13/16"-20 - 1H T/S

RP5650▲
 Spout Assembly - 8"- 2H Kitchen
 Ensamble del Tubo de Salida -
 8"- 2H Cocina

RP5651▲
 Metal Pop-Up Drain Assembly
 w/Metal Lift Knob / Ensamble del
 Desagüe Automático de Metal con
 Botón-Metal-para Alzar el Desagüe

RP5653▲
 Spout Assembly - 10"- 1H Kitchen
 Ensamble del Tubo de Salida -
 10"- 1H Cocina

RP5654▲
 Spout Assembly - 8"- 1H Kitchen
 Ensamble del Tubo de Salida -
 8"- 1H Cocina

RP5833▲
 Tub Spout-Non Diverter-
 4 1/2" Long - 1/2" IPS
 Tubo de Salida-Sin Desviador-
 4 1/2" Largo - 1/2" IPS

RP5834
 Tub Spout - Pull-up Diverter -
 5" Long - 1/2" IPS or 1/2" CWT
 Tubo de Salida-Desviador de Alzar-
 5" Largo - 1/2" IPS o 1/2" CWT

RP5836
 Tub Spout - Pull-Down Diverter -
 Easy Slip-On - 5 1/4" Long-1/2" CWT
 Tubo de Salida-Desviador de Halar-
 Fácil Deslice - 5 1/4" Largo-1/2" CWT

RP5861
 Coupling Nuts-Mounting
 Tuercas de Acoplamiento-Montura

RP5876
 Complete Screwdriver Stop - 1/2" IPS -
 1H Tub/Shower except Castings
 Tope-Destornillador Completo -
 1/2" IPS - 1H Bañera/Regadera
 Excepto Piezas Fundidas

RP5883▲
 Escutcheon - 600/1600
 Chapetón - 600/1600

RP5885
 Screws - SS - .560"x10-24 -
 2H Knob - Kitchen/Lav
 Tornillos - Acero Inoxidable -
 .560"x10-24-2H Perilla - Coc/Lav

RP5893▲
 Sleeve-600
 Manguito-600

RP6001
 Mounting Nuts & Washers-100/400
 Tuercas de Montar y Arandelas-
 100/400

RP6005
 Complete Screwdriver Stop -
 1/2" CWT- 1H T/S except Castings
 Tope Destornillador Completo -
 CWT 1/2"- 1H T/S Excepto con
 Piezas Fundidas

RP6011
 Spray & 4' Hose Assembly - 1/4"-18
 NPSM Female Swivel Nut - 1/8" NPT Male
 Adapter - 1/8" Female Stationary Nut
 Adapter / Rociador y Ens. de Manguera -
 1/4"-18 NPSM Tuerca Hembra Giratoria
 1/8" NPT Adaptador Macho - 1/8" Tuerca
 Adaptadora Fija Hembra

RP6015▲
 Spray Support Assembly
 Ensamble del Soporte del Rociador

RP6019▲
 Deep Escutcheon -
 600/1600 Series - 1" Deeper
 Chapetón Hondo -
 Series 600/1600 - 1" Mas Hondo

RP6023▲
 Shower Arm
 Brazo de Regadera

RP6025▲
 Shower Flange
 Brida para Regadera

RP6042▲
 Spout Assembly-12"-1H Kitchen
 Ensamble del Tubo de Salida-
 12"-1H Cocina

RP6044
 Slip Ring-Spout-100/300/400
 Anillo de Frot.-Tubo de Salida-
 100/300/400

RP6046▲
 Escutcheon-Push Button Diverter-600
 Chapetón-Desviador de Botón a
 Presión-600

RP6048
 O-Ring - 2H Waterfall® Kitchen &
 NEO STYLE™ Lav / Aro-O - 2H para
 cocinas modelo Waterfall® y para
 lavamanos NEO STYLE™

RP6050
 Hose-16"- 2H W/S Kitchen & Lav -
 1/4"-18 NPSM
 Manguera-16"- 2H W/S Cocina y Lav -
 1/4"-18 NPSM

RP6052
 Gasket
 Empaque

RP6056
 Nut & Washer-Spout -
 High-Rise Widespread
 Tuerca y Arandela - Tubo de
 Salida - Alto y Extendido

RP6060▲
 Bonnet Nuts-2H Kitchen/Lav
 Bonetes/Capuchones- 2H
 Cocina/Lav

RP6068▲
 Button-Plug-2H Lav Spout
 Botón-Tapón-2H Tubo de
 Salida Lav

RP6073
RP6073MBS (30 per case/30 por caja)
 Diverter Assembly - 2H Kitchen w/Spray
 Ensamble del Desviador - 2H Cocina con
 Rociador

RP6079▲
 Bonnet - 1600
 Capuchón - 1600

RP6081▲
 Sleeve - 1600
 Manguito - 1600

RP6083▲
 Escutcheon - 1600
 Chapetón - 1600

RP6087
 Nut & Washer - Spout -
 Widespread Lav
 Tuerca y Arandela - Tubo de
 Salida - Lav-Extendido

Miscellaneous Parts / Piezas Misceláneas

Miscellaneous Parts / Piezas Misceláneas

RP6092
Nuts & Washers - 500
Tuercas y Arandelas - 500

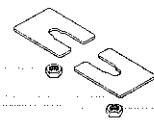

RP6126
Flange - Pop-Up Drain Assembly
Brida-Ensamble del Desagüe Automático

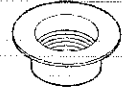

RP6130
Pivot Seat & Gasket - Pop-Up Drain Assembly
Asiento Pivoteado y Empaque-Ensamble del Desagüe Automático



RP6132
Nut - Pop-Up Drain Assembly
Tuerca - Ensamble del Desagüe Automático



RP6142
Gasket - Pop-Up Drain Assembly
Empaque - Ensamble del Desagüe Automático



RP6146▲
Lift Rod Assembly
Ensamble de la Barra de Alzar

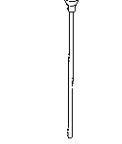

RP6183
Locknuts-Mounting - 2H
Contratuercas-Montura - 2H



RP6185
Screwdriver Stop Assembly - For T/S Models w/Stops (Casting)
Ensamble del Tope Destornillador - Para Modelos T/S con Topes (Fundidos)



RP6205
Escutcheon-Rectangular-Red/Blue Label-1600/1700 Pres. Bal. Series
Chapetón-Rectangular-Etiqueta Roja/Azul-Series de Pres. Bal. - 1600/1700



RP6315
Mounting Nut & Washer - 300-D
Tuercas de Montura y Arandela - 300-D



RP6365
O-Ring
Anillo "O"



RP6369
Screw - SS-10-24x.460" Handle
Tornillos - Aceros de Inoxidable - 10-24x.460"-Manija



RP6399
Stem Assembly - Slow Self-Close
Ensamble de la Espiga-Cierre Lento Automático



RP6404▲
Screws - Overflow Plate - 1 3/4"x1/4"-20 - All Bath Waste Drain Assemblies
Tornillos-Placa de Desborde- 1 3/4" x 1/4"-20 Ensamble de Desagüe de Bañera



RP6463
Snap 'N Pop-Up® Drain Assembly - Non-Metallic
Ensamble del Drenaje Automático Snap 'N Pop-Up® - No Metálico

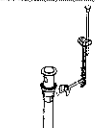

RP7430▲
Dome Strainer w/Screw for RP291/RP391/RP691
Colador-Forma de Cúpula-con Tornillo-Ensamble del Drenaje de Bañera para RP291/RP391/RP691



RP8230
RP8230MBS (30 per case/30 por caja)
Ceramic Stem Unit, Seat, O-Ring, Spring & Screw - 2H
Unidad de la Espiga de Cerámica, Asiento, Anillo "O", Resorte y Tornillo-2H

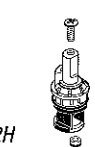

RP9519
Mounting Nuts & Washers- W/S / Tuercas y Arandelas de Monturas-W/S



RP9595▲
Trip Lever Assembly - For Most 2 Piece Water Closets
Ensamble de la Palanquita de Desenganche-Para Casi Todos los Inodoros de Dos Piezas



RP10208
Button Set - 7/8" Dia.
Botones - 7/8" Dia.



RP10612
Thick Tile Mounting Kit-Adds 1"
Equipo/Herramientas para Monturas en Losa Gruesa-Más 1"



RP10799
Diverter Assembly - 3H T/S (casting) - See RP21598 if Seal Keeps Tearing
Ensamble del Desviador - 3H T/S (fund.) - Ver RP21598 si el sello se rasga



RP10965▲
Base w/Gasket - W/S End Valve - 2" Diameter
Base con Empaque - Válvula Final W/S - 2" Dia.

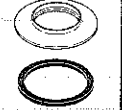

RP11079
Fiberglass Mounting Bracket-Bulk Pack of RP3888
Soporte para Montar de Vidrio Fibroso - Equipo de Cantidades Grandes de RP3888

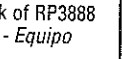

RP11096
Thick Tile Mounting Kit- Bulk Pack of RP10612
Equipo/Herramientas para Monturas en Losa Gruesa - Equipo de Cantidades Grandes de RP10612



RP11099
Thick Tile Mounting Kit - Bulk Pack of RP18504
Equipo/Herramientas para Monturas en Losa Gruesa - Equipo de Cantidades Grandes de RP18504

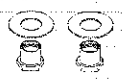

RP11721
Mounting Bracket - 462/466
See RP38718 (New Mounting Bracket)
Abrazadera de Montura - 462/466
Vea (RP38718) Abrazadera para Instalación Nueva

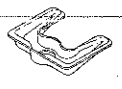

RP11722
Nut & Wrench - (130, 430, 172, 173, 174, 460, 461, 462, 466)
Tuerca y Llave - (130, 430, 172, 173, 174, 460, 461, 462, 466)

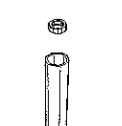

RP118400▲
Body Pin - Oversize
Espiga - Muy Grande

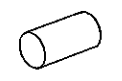

RP12301
Vacuum Breaker Ball Assembly- SS - Single Lever - Pull-Out Spray Models
Ensamble de la Bola para Romper el Vacío

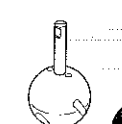

RP12490
Screws - Red/Blue - VR - Lever Handle - 10-24x5/8"
Tornillos - Rojo/Azul - Resistente al Maltrato - Palanca - 10-24x5/8"

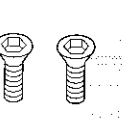

RP12516
Strap & Screw Metal Pop-Up Drain Assembly
Barra Chata y Tornillos - Ensamble del Desagüe Automático - Metálico

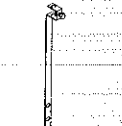

RP12517
Horizontal Rod w/Clip - Metal Pop-Up Drain Assembly
Barra Horizontal con Grapa - Ensamble del Desagüe Automático - Metálico

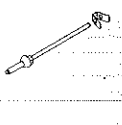

RP12518
Spring Clip - Metal Pop-Up Drain Assembly
Grapa de Resorte - Ensamble del Desagüe Automático - Metálico



RP12629
Screws - 2/3H T/S-Knob-10-24x3"
Tornillos - 2/3H T/S-Perilla-10-24x3"



RP12630▲
Screws - 2/3H T/S-Lever-10-24x3 3/4"
Tornillos - 2/3H T/S-Palanca- 10-24x3 3/4"



**RP12631 - See RP18627 Extender Plus Appropriate Screw (RP12629, RP12630, RP20184 or RP12574)
Ver RP18627 Extensión Más Tornillo Apropiado (RP12629, RP12630, RP20184 o RP12574)**

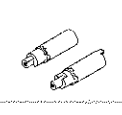

RP13938
O-Ring - 4530
Anillo "O" - 4530



RP14414
O-Rings - 1300/1400
Anillos "O" - 1300/1400

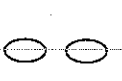

RP14979▲ LHP
RP14979▲
Roman Tub Hand Held Shower - 2.5 gpm @ 80 psi
Regadera de Mano para Bañera Romana - 9.5L/Min @ 551 kPa

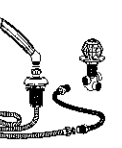

RP14991▲
Hand Piece - RT Hand Shower - 2.5 gpm @ 80 psi
Pieza de Mano - RT Regadera de Mano - 9.5L/Min @ 551 kPa



RP16201
Button
Botón



RP16208
Seats, Springs & Quad Rings - 1500
Asientos, Resortes y Anillos Cuatro - 1500



RP16213
Screwdriver Stop Assembly - 1300/1400/1500/RP6005/RP5876
Ensamble del Tope Destornillador - 1300/1400/1500/RP6005/RP5876

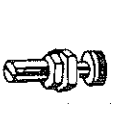

RP16686▲
Stopper Assembly
Ensamble del Tapón

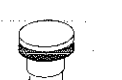

RP16687▲
Waste Plug
Tapón del Desagüe

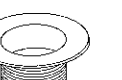

RP17443▲
Lever Handle w/Set Screw - 1H Lav/600
Palanca con Tornillo de Ajuste - 1H Lav/600

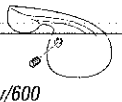

RP17445
Base Plate - 1H Centerset Lav
Placa - 1H Lav de Centro



RP17446▲
Button - Clear-Wave - 1H Centerset Lav - 1 1/2" Dia.
Botón - Dibujo de Transparente - 1H Lav de Centro - 1 1/2" Dia.



RP17449▲
Handle w/Button & Screw - Clear Knob - 1H Centerset Lav
Manija con Botón y Tornillo - Perilla de Transparente - 1H Lav de Centro

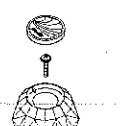

RP17451▲
Handle w/Button & Screw - Clear Knob - 600
Manija con Botón y Tornillo - Perilla de Transparente - 600



RP17453▲
Tub Spout - Pull-Down Diverter - Non-Metallic - 1/2" IPS or 1/2" CWT
Tubo de Salida para Bañera-Desviador de Halar - No Metálico- 1/2" IPS o 1/2" CWT

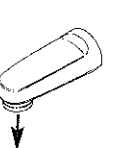

Pull-Down Halar Hacia Abajo

RP17454▲
Tub Spout - Pull-Down Diverter - Metal-1/2" IPS or 1/2" CWT
Tubo de Salida para Bañera-Desviador de Halar-Metálico- 1/2" IPS o 1/2" CWT

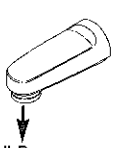

Pull-Down Halar Hacia Abajo

RP17472
Removable Decal for Pull-Down Spout Operation
Etiqueta para la Operación de Halar el Tubo de Salida Hacia Abajo

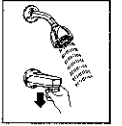

RP17498
Escutcheon Label - Red/Blue - 600/1600
Etiqueta de Chapetón - Rojo/Azul - 600/1600



RP17730
Diverter Assembly - 3H T/S - (Fabricated Brass Body)
Ensamble del Desviador - 3H T/S - (Cuerpo de Fabricados de Bronce)

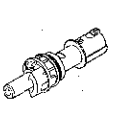

RP17786▲
Spray & 4' Hose Assembly - White or Biscuit Head - 1/4"-18 NPSM Female Swivel Nut - 1/8" NPT Male Adapter - 1/8" Female Stationary Nut
Rociador y Ensamble de Manguera de 4' - Cabeza Blanca - Boige 1/4"-18 NPSM Tuerca Giratoria Hembra - 1/8" NPT Adaptador Macho 1/8" Tuerca Fija Hembra

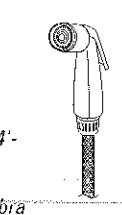

RP17829
Wall Decal - Pull-Down Diverter Tub Spout Operation
Etiqueta Adhesiva para Pared-Halar Hacia Abajo - Operación del Desviador del Tubo de Salida de Bañera



RP18090
Screw-On Escutcheon - Non-Metallic - 3 1/2" Dia. - 2/3H T/S
Chapetón Atornillador - No Metálico- 3 1/2" Dia.-2/3H T/S



RP18136▲
Screw-On Sleeve - 2/3H T/S
Manguito Atornillador - 2/3H T/S

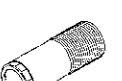

RP18187
Thin Wall Mounting Spacers
Separadores para Paredes Delgadas

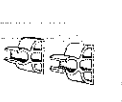

RP18227
Conventional Rough-In Kit - Roman Tub Deck
Equipo para Instalación de Válvulas en Paredes - Borde de Bañera Romana

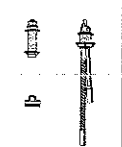

RP18235
Thick Tile Rough-In Kit - Roman Tub Deck
Equipo para Instalación de Válvulas en Paredes - Borde de Bañera Romana

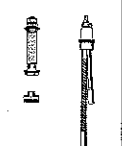

RP18276▲
Screw-On Escutcheon - Metal - 3 1/2" Dia. - 2/3H T/S
Chapetón Atornillador - Metálico - 3 1/2" Dia. - 2/3H T/S



RP18300▲
Base w/Gasket - 2 1/2" Dia. - 3/16" Collar-Roman Tub Deck
Base con Empaque - 2 1/2" Dia. - 3/16" Collar-Borde de Bañera Romana

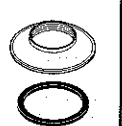

RP18358▲
Plug Button & Screw-2710/2730/2780
Botón de Tapón y Tornillo - 2710/2730/2780

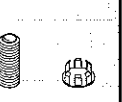

RP18363
Nut & Washers - Roman Tub Deck Conv. Rough-In
Tuercas y Arandelas - Preparación de Instalación Convencional para Montura de Bordes de Bañeras Romanas

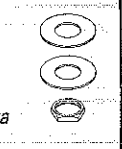

RP18364
Spout Adapter Assembly - Roman Tub Deck Conv. Rough-In
Ensamble de Adaptador del Tubo de Salida - Preparación de Instalación Convencional para Montura de Bordes de Bañeras Romanas

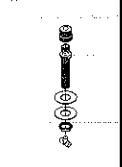

RP18370
Nuts & Washers - Roman Tub Deck Conv. Rough-In
Tuercas y Arandelas - Preparación de Instalación Convencional para Montura de Bordes de Bañeras Romanas



RP18373▲
Button Set-Clear Wave - Red/Blue - 2H Knob - 1 1/2" Dia.
Botones - Dibujo de Transparente-Rojo/Azul - 2H Perilla - 1 1/2" Dia.



RP18395
Set Screw / Tornillo de Ajuste - 2710/2730/2780

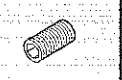

Miscellaneous Parts / Piezas Misceláneas

Miscellaneous Parts / Piezas Misceláneas

RP18429▲
Arrow Button - RT Hand Shower - 1 1/2" Dia.
Botón de Flecha - RT Regadera de Mano - 1 1/2" Dia.

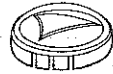

RP18442
Arrow Button - Red/Blue - 502/552/602/752/RP18860/RP21771 - 1 1/2" Dia. - Silver Insert
Botón de Flecha - Rojo/Azul - 502/552/602/752/RP18860/RP21771 - 1 1/2" Dia. - Botón de Plata



RP18454▲
Aerator - NEO STYLE™ Kit/Lav - 2.0 gpm @ 80 psi
Aireador - NEO STYLE™ Coc/Lav - 7.6L/Min @ 551 kPa



RP18504
Thick Tile Mounting Kit - Roman Tub Deck Conv. Installation Kit - Adds 1" to End Valves
Herramientas para Monturas en Losa Gruesa-Preparación de Instalación Convencional para Montura de Bordes de Bañeras Romanas - ávulas Final para Más 1"



RP18508▲
Aerator w/Screen - Highrise Spouts - 2.0 gpm @ 80 psi - 15/16"-27 Male Thread
Aireador con Rejilla - Tubo de Salida Alto-7.6L/Min @ 551 kPa-15/16"-27 Rosca Macho



RP18543▲
Base w/Gasket-3" Dia.-2710/2780
Base con Empaque-3" Dia.-2710/2780



RP18627
Extender - 2/3H T/S
Extension - 2/3H T/S

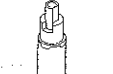

RP18632▲
Transfer Valve - RT Hand Shower - 3" Base
Válvula de Direccional - RT Regadera de Mano - Base de 3"



RP18724 (12 per case/12 por caja)
Thin Wall 2/3H T/S Mounting Spacers - Bulk
Pared Delgada 2/3H T/S Separadores para Montar - En Cantidades Grandes

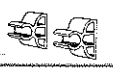

RP19653
Diverter Assembly - RT Hand Shower
Ensamble del Desviador - RT Regadera de Mano

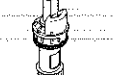

RP19659▲
Button Set - Clear - 2 Handle Knob-Red/Blue Indicator - 1 5/16" Dia.
Botones-Transparente - 2H Perilla - Indicadores Rojo/azul - 1 5/16" Dia.



RP19804
Cartridge Assembly - SS Plate - 1300/1400
Ensamble del Cartucho - Placa de Acero Inoxidable - 1300/1400



RP19805
Lower Housing Assembly of RP19804 Cartridge
Ensamble de la Conexión de Entrada Inferior de RP19804 Cartucho



RP19806
Upper Cap of RP19804 Cartridge
Tapa Superior de RP19804 Cartucho



RP19807
Rotational Limit Stop - 1300/1400
Tope para Limitar - 1300/1400



RP19809▲
Escutcheon - Diagonal Esc. Screw Holes - 1300/1400
Chapetón - Chapetón Diagonal - 1300/1400



RP19820
Tub Spout - Pull-Up Div.-Easy Slip-On - Non-Metallic - 1/2" CWT
Tubo de Salida para Bañera - Botón Desviador de Alzar - No Metálico-1/2" CWT



RP19895
Tub Spout - Pull-Up Diverter - 1/2" IPS
Tubo de Salida para Bañera - Botón Desviador de Alzar - 1/2" IPS



RP20032
Brass Pipe Plug - 1/2" CWT-T/S
Tapón de Bronce de Tubería - 1/2" CWT-T/S

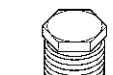

RP20049
Spout O-Ring - Thick - 2167/2467/2474
Anillo "O" del Tubo de Salida - Grueso - 2167/2467/2474



RP20111
SS Conversion Ball-Knob to Lever
Bola de Conversión de Acero Inoxidable-Cambia de Perilla a Manija de Palanca



RP20184
Retention Screws - 10-24x3"
Tornillos de Retención - 10-24x3"



RP20185
Retention Screws - 10-24x1/2"
Tornillos de Retención - 10-24x1/2"

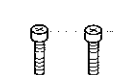

RP20542▲
Arrow Button - Red/Blue Indicators - 1 1/2" Dia. - 1300/1400/1600
Botón de Flecha-Indicadores Rojo/Azul - 1 1/2" Dia. - 1300/1400/1600



RP21462▲
Spout w/Aerator - 9 1/2" Long
Tubo de Salida con Aireador - 9 1/2" Largo



RP21463
Spout Retainer - Waterfall® Kitchen
Retención del Tubo de Salida - Waterfall® Cocina

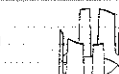

RP21547▲
Spout Assembly - 462/466
Ensamble del Tubo de Salida - 462/466



RP21633▲
Deep Escutcheon - 1300/1400/1500 - 1" Deeper-Diagonal Esc. Screw Holes
Chapetón de Hondo - 1300/1400/1500 - 1" Más Hondo - Huecos para los Tornillos Diagonal



RP21904
Bottle - Soap/Lotion Dispenser-10 oz.
Botella - Surtidor de Jabón/Loción - 10 oz.



RP21905▲
Pump Head - Soap/Lotion Dispenser
Cabeza de la bomba - Surtidor de Jabón/Loción

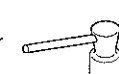

RP21908
Pump - Soap/Lotion Dispenser
La Bomba - Surtidor de Jabón/Loción

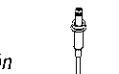

RP21945
Nut-Soap/Lotion Dispenser
Tuerca - Surtidor de Jabón/Loción

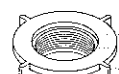

RP22132
Helpful Hand Installation Aid - 4"-16" Widespread - Holds & Aligns Handles
Utensilio para Asistencia en Instalaciones a Mano - 4"-16" W/S - Sujeta y Alinea las Manijas



RP22734
Bonnet - Unplated - 1300/1400/1500
Bonete - Sin Acodado - 1300/1400/1500



RP22735▲
Trim Sleeve-1300/1400
Manguito de Accesorio - 1300/1400

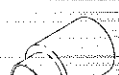

RP22737▲
Trim Sleeve, Bonnet & O-Ring - 1300/1400
Manguito de Accesorio, Bonete y Anillo "O" - 1300/1400



RP22934
Spout O-Rings - Waterfall® Kitchen
Anillos "O" de Salida - Waterfall® Cocina

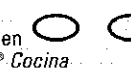

RP23060▲
Drain Flange - Metal Pop-Up Drain Assembly
Brida de Drenaje - Ensamble de Desagüe Automático de Metal



RP23094▲
Scalloped Handle Base w/Gasket - 2730/2731/2767/2768/2770/2771
Base de Festón con Empaque - 2730/2731/2767/2768/2770/2771



RP23095▲
Scalloped Handle Base w/Gasket - 2147/2447/3530/3567/3577
Base de Festón con Empaque - 2147/2447/3530/3567/3577



RP23336
Body O-Ring - 1300/1400/1500
Anillo "O" de Cuerpo - 1300/1400/1500



RP23489
Plumbers Hook - Seat, Spring & Spout O-Ring Removal Tool
Gancho de Plomero - Asiento, Resorte y Herr. para Sacar Anillo "O" del Tubo de Salida



RP23498
Clear Knob Handles w/Buttons & Screws - 2H
Manijas de Perilla Transparente con Botones y Tornillos - 2H



RP24096
Stem Unit Assembly - Brass Stem - SS Plate
Ensamble de la Unidad del Vástago - Vástago de Bronce - Placa de Acero Inoxidable



RP24097
1/4 Turn Stop for RP24096 (Optional)
Tope de Pare 1/4 para RP24096 (Opcional)



RP25423▲
Hose, Full Flow Aerator & Adapter w/Flow Control-462/466
Manguera, Aireador de Flujo Completo y Adaptador con Control de Flujo-462/466



RP25513
Stem Unit Assembly w/Brass Stem-SS Plate & 1/4 Turn Stop - 2H
Ensamble de la Unidad del Vástago con Vástago de Bronce - Placa de Acero Inoxidable y Tope a un 1/4 de Rotación - 2H

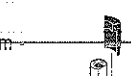

RP25592
Extender for Diverter Handle (Aligns Lever Handles Vertically). NOTE: Use RP18627 Extender when using the H17 Porcelain Cross Diverter Handle.
Extensión para Manija Desviadora (Alinee las Manijas de Palanca Verticalmente). NOTA: Use la Extensión RP18627 cuando use el Desviador para la Cruz de Porcelana H17.



RP25620
Set Screws for Small & Medium Side Mount Handles - 10-32x5/16" (Use 3/32 Allen Wrench) / Tornillos de Ajuste para Manijas de Montura de Lado Pequeña y Mediana - 10-32x5/16" (Uso 3/32 Llaves de Allen)



RP26533▲
Metal Pop-Up Assembly
Less Lift Rod
Ensamble del Desagüe Automático de Metal Sin Barra de Alzar



RP26852▲
Spindle for H14/H24/H54/H64/H74
Husillo para H14/H24/H54/H64/H74

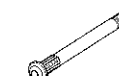

RP26880▲
Spray Head
Cabeza del Rociador

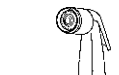

RP26853
Allen Wrench for Side Mount Handles - 3/32"
Llave de Allen para Manija de Montura de Lado-3/32"



RP26865
Set Screws for Large Side Mount Handles - 10-32x5/8" (Use 3/32" Allen Wrench) / Tornillos de Ajuste para Manijas de Montura de Lado Grande-10-32x5/8" (Uso Llave de Allen 3/32")



RP28595▲
Temperature Knob and Cover
Perilla de la Temperatura y Cubierta



RP28598
Red/Blue Decal - 1700 Handles
Calcomanía Roja/Azul - Manijas 1700



RP28599▲
Push-Clean® Showerhead
Cabeza de Regadera Push-Clean®



RP28601▲
Dual Spray Touch-Clean® Showerhead
Cabeza de Regadera de Doble Rociador Touch-Clean®



RP28602▲
Ultimate Touch-Clean® Showerhead
Cabeza de Regadera Touch-Clean® Ultimate



RP28603
Seats, Springs & Quad Seal - 1700/1800
Asientos, Resortes y Sello de Goma - 1700/1800

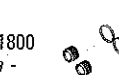

RP28900▲
Spray & Hose Assembly
Ensamble de la Manguera y Rociador

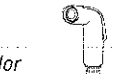

RP28906
Red/Blue Button
Botón de Rojo y Azul



RP29405
Conversion Kit - Monitor® 1500 to 1700 Series
Control para las Herramientas de Conversión para las series Monitor® desde 1500 hasta 1700



RP29569
Spacer
Separadores



RP29827▲
Renovation Cover Plate
Placa de Cubierta de Renovación

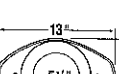

RP29993
Plaster Guard/Thin Wall Mounting Bracket / Cubierta Protectora Contro el Yeso/ Abrazadera de Montura para Pared Delgado



RP30392
Thick Deck Mounting Kit for 2 1/2" Max. Decks / Juegos de herramientas para instalación en bordes gruesos para 2 1/2" max de grosor de bordes



RP30395
Vented Funnel
Embudo con Ventiladero

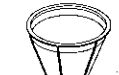

RP31554▲
Shower Arm & Flange
Brazo de Regadera y Chapetón



RP31611▲
Spray Head (Carded)
Cabeza del Rociador (en tarjeta)



RP31612▲
Universal Spray and Hose Replacement Kit (Carded)
Juego de Piezas de Reemplazo (en tarjeta) para el Rociador Universal y la Manguera



RP31704
Spray Outlet w/Wrench - 1/2 GPM - Vandal Resistant / Boca de Salida del Rociador con Llave - 1/2 GPM - Resistente al Maltrato



RP31845
Thick Deck Nut
(For 2 1/2" Max. Thick Decks) Tuerca para instalación en bordes gruesos (Para 2 1/2" max de grosor de bordes)



MISCELLANEOUS PARTS

RP32102
Rotational Limit Stop - 1700/1800
Tope para Limitar-1700/1800



RP32103▲
Handle Assembly - 1700/1800
Ensamble de la Manija-1700/1800

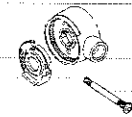

RP32104
Cartridge Assembly - 1700/1800
(includes RP32102)
Cartucho - 1700/1800
(incluye RP32102)

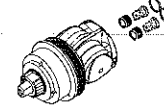

RP32105
Screw-Handle-1700
Tornillo-Manija-1700

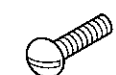

RP32106▲
Handle Kit (Includes RP32104
Cartridge Assembly)
(Replace all parts to resolve stiff
handle problem) - 1700/1800
Herramientas para la Manija
(Incluido Ensamble de la
Cartucho RP32104)
(Para resolver el problema de manijas tiesas
reemplace todas las piezas) - 1700/1800

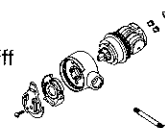

RP32520
O-Rings - Spout - 470/472
Anillos O - Tubo de Salida -
470/472



RP32522
Clip - Hose - 470/472/474/476
Presilla - Manguera -
470/472/474/476



RP32527
Hose Assembly -
470/472/474/476
Ensamble de la Manguera -
470/472/474/476

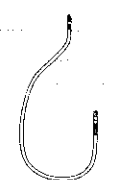

RP32538
Personal Hand Held Shower with Wall
Mount Bracket / Regadera de Mano
Personal con Abrazadera para
Instalación en la Pared



RP32539
Personal Hand Held Shower with
Adjustable Slide Bar
Regadera de mano personal con
Barra Deslizable Ajustable

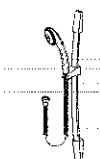

RP32540▲
Personal Hand Held Shower
with Wall Mount Bracket
Regadera de Mano Personal
con Abrazadera para
Instalación en la Pared

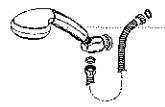

RP32541▲
Personal Hand Held Shower with
Adjustable Slide Bar
Regadera de mano personal con
Barra Deslizable Ajustable

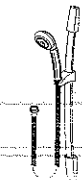

RP32542▲
Wand Assembly-470/472/474/476
Ensamble de la Cabeza del
Rociador-470/472/474/476

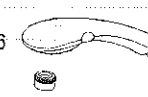

RP32549▲
Supply Elbow
Codo Abastecedor

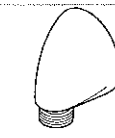

RP32550▲
Shower Arm Diverter for Handshower
Desviador de Brazo Regadera para
Regadera de Mano

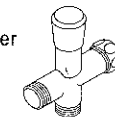

RP33791▲LHP
Roman Tub Hand Held Shower -
Victorian
Regadera de mano para
Bañeras Romanas - Victorian

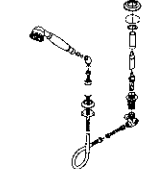

RP33794
Adapter Assembly -
Slip-On Tub Spout
Ensamble de Adaptador -
Surtidor deslizable para Bañeras

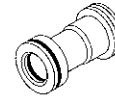

RP33805
Horizontal Rod 10 1/8" Long
Barra horizontal de 10 1/8"
de largo

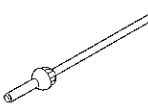

RP34345▲
Aerator - Victorian
Aireador - Victorian

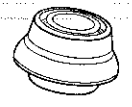

RP34352
Quick-Snap® Hose Assembly
Ensamble de la Manguera
de Quick-Snap®

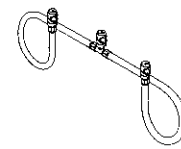

RP34355▲
Traditional Showerhead
Cabeza de Regadera
Tradicional

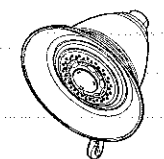

RP34357▲
Tub Spout - Pull-up Diverter -
7 1/2" Long - 1/2" IPS or 1/2" CWT
Tubo de Salida - Desviador de
Alzar - 7 1/2" Largo - 1/2" IPS
o 1/2" CWT



RP34849
1/2" Female IPS Pipe Cap - Brass
Tapa hembra de bronce de la
tubería IPS de 1/2"

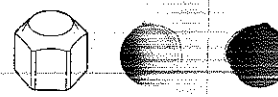

RP36497▲
Tub Spout - Pull-up Diverter - 7"
Long - Slip onto 1/2" CWT
Tubo de Salida - Desviador de
Alzar - 7" Largo - 1/2" CWT

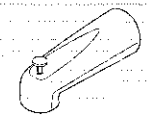

RP36498▲
Tub Spout - Non Diverter -
7" Long - Slip onto 1/2" CWT
Tubo de Salida - Sin Desviador -
7" Largo - 1/2" CWT

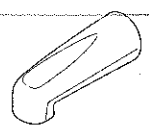

RP37033
Quick-Snap® Spout Hose
Manguera de Quick-Snap®



RP37039▲
Victorian Collection
Soap/Lotion Dispenser
Dispensador de Jabón/Loción
de la Colección Victorian



RP37079▲
Traditional Shower Arm
Brazo de Regadera y
Chapatón Tradicional



RP37731▲
Sleeve - 1700
Manguito - 1700

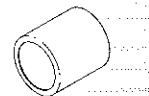

RP37776
Thick Deck Mounting
Kit for 2 1/8" Deck
Juegos de herramientas
para instalación en bordes gruesos
para 2 1/8" max de grosor de bordes

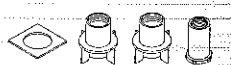

RP38357
Touch-Clean® Showerhead
Cabeza de Regadera
Touch-Clean®

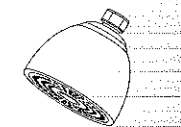

RP38671▲
Saxony™ Series
Soap/Lotion Dispenser
Dispensador de Jabón/Loción
de la series Saxony™

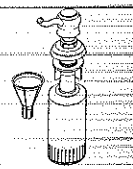

RP39345▲
Spray & Hose Assembly -
Quick-Snap®
Ensamble de la Manguera
y Rociador - Quick-Snap®

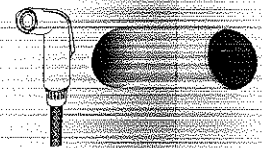

RP39360▲
Spray & Hose Assembly-Quick-Snap®
Ensamble de la Manguera y Rociador -
Quick-Snap®

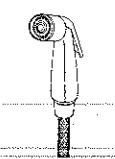

RP39379
Large Botanical™ Color Accents
for H517/H717 and accessories
Accesorios Grandes de Colores para
las manijas H517/H717 Botanical™
y accesorios

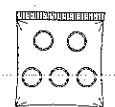

RP39377
Small Botanical™ Color Accents
for H217
Accesorios pequeños de Colores
para las Manijas H217 Botanical™

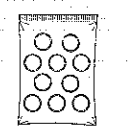

RP39407▲
Trim Sleeve - 1400
Manga de Franja - 1400



RP39378
Large Botanical™ Color Accents
for H617 and accessories
Accesorios Grandes de Colores
para las manijas H617 Botanical™
y accesorios

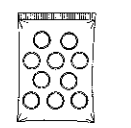

RP40301
Quick-Snap® Vegetable
Spray Cap
Tapa para el Rociador de
Vegetales de Quick-Snap®

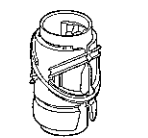

RP40307
Widespread Quick-Snap®
Hose for All Kitchen and
Lavatory Widespreads - 67"
Manguera de Quick-Snap® para
llaves de agua extendidas para todos los
fregaderos y lavamanos extendidos de 67"

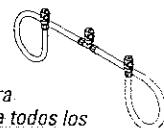

RP40784
Quick-Snap® Spout Hose - 45"
Manguera de Quick-Snap® - 45"

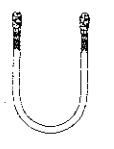

RP41478
Quick-Snap® Nut & Adapter
Tuerca y Adaptador
de Quick-Snap®

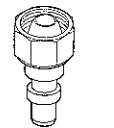

Mounting Hardware for Accessories
Herramientas para la Instalación de Accesorios

Traditional Series

RP42221*
2 set screws, one Allen wrench
Dos tornillos de presión, una llave Allen
RP42225*
One mounting post with 2 screws and anchors
Un poste de soporte de instalación con 2 tornillos y anclas

Innovations® Series

RP30317
2 set screws, one Allen wrench
Dos tornillos de presión, una llave Allen
RP24290
One wall mounting bracket with 2 screws and anchors
Un Soporte para el montaje de pared, dos tornillos, dos anclas

NEO STYLE® Series

RP42222*
2 set screws with slotted heads
2 tornillos de ajuste con cabezas con ranuras
RP24290
One wall mounting bracket with 2 screws and anchors
Un Soporte para el montaje de pared, dos tornillos, dos anclas

Victorian™ Collection

RP41996*
2 set screws, one Allen wrench
Dos tornillos de presión, una llave Allen
RP40241* (for towel bars & tissue paper holder)
One long mounting post, two screws, two anchors
Un poste de soporte largo de instalación, dos tornillos, dos anclas
RP40679* (for towel ring, robe hook, soap dispenser & tumbler holder)
One short mounting post, two screws, two anchors
Un poste de soporte corto de instalación, dos tornillos, dos anclas

Botanical™ Series

RP42223* (for Colored Accents)
2 set screws, one Allen wrench
Dos tornillos de presión, una llave Allen
RP42224*
2 set screws, one Allen wrench
Dos tornillos de presión, una llave Allen
RP24290
One wall mounting bracket with 2 screws and anchors
Un Soporte para el montaje de pared, dos tornillos, dos anclas

Michael Graves Collection™

RP42224*
2 set screws, one Allen wrench
Dos tornillos de presión, una llave Allen
RP24290
One wall mounting bracket with 2 screws and anchors
Un Soporte para el montaje de pared, dos tornillos, dos anclas

MISCELLANEOUS PARTS

Model Number Suffix Designations & Abbreviations

(see bottom of page for handle and handle accent suffixes)

No suffix	—	Chrome	MBS	—	Mini-Bulk
AB	—	Antique Brass Finish	MDS	—	Metal Tub Spout with Lift-Up Diverter
AC	—	Alternating Current (Electronic Faucets for Hard Wire Installation)	MIX	—	Mixing Valve (R2300-MIX)
ACL	—	Clear Handle Accent	MP	—	Matte Black with <i>Brilliance</i> ® Polished Brass Finish
AL	—	Almond Finish or Trim	MPU	—	Metal Pop-Up Drain
AP	—	Almond with <i>Brilliance</i> ® Polished Brass Finish	NC*	—	<i>Brilliance</i> ® Pearl Nickel and Chrome Finish
AWH	—	White Handle Accent	NN*	—	<i>Brilliance</i> ® Pearl Nickel Finish
BL	—	Matte Black Finish	NP*	—	<i>Brilliance</i> ® Pearl Nickel and <i>Brilliance</i> ® Polished Brass Finish
BRS	—	Brass Lever Handles	NPS	—	Non-Metallic Pull-Down Spout
BS	—	Biscuit Finish	NPSM	—	National Pipe Thread Straight Mechanical
C	—	Copper Sweat Inlets	NPT	—	National Pipe Thread Tapered
CB	—	Chrome and <i>Brilliance</i> ® Polished Brass Finish	OAK	—	Oak Wood Handles
COL	—	Cold Handle	OG	—	Offset Grid Strainer
CP	—	<i>Brilliance</i> ® Polished Brass and Chrome Finish	OTR	—	Over-the-Rim Tub Spout (no diverter)
CW	—	Chrome with White Finish	P	—	Metal Pop-Up Drain
CWT	—	Copper Water Tube	PB*	—	<i>Brilliance</i> ® Polished Brass Finish
D	—	Single Soap or Lotion Dispenser	PN	—	<i>Brilliance</i> ® Polished Nickel Finish
ELH	—	6" Long Elbow Handle (RP5645)	POR	—	Porcelain Lever Handles
ELT	—	Extra Long Tubes	PSI	—	Pounds Per Square Inch (US Unit of Pressure)
GH	—	(Handle Prefix) - Michael Graves Collection™ Handle	PW	—	<i>Brilliance</i> ® Polished Brass with White Finish
GLHP	—	Michael Graves Collection™ - Less Handle Program	RB	—	Venetian Bronze™ Finish
GPM	—	Gallons Per Minute (US Flow Rate)	RD	—	Red Finish or Trim
GR	—	Gray Finish or Trim	ROS	—	Rosewood Lever Handles
HGM	—	Half Gallon per Minute Flow Rate (Vandal Resistant Outlet - RP31704)	SBH	—	Short Ball Handle (RP90)
HOT	—	Hot Handle	SB	—	Satin Brass or Antique Brass Finish
HTL	—	Red/Blue Temperature Indicator Handle Button	SOS	—	Slip-on Spout for 1/2" - C.W.T.
IPS	—	Iron Pipe Size	SPW	—	White Vegetable Spray
kPa	—	Kilopascals (Metric Unit of Pressure)	SS	—	<i>Brilliance</i> ® Stainless Finish
L	—	Liters Per Minute (Metric Flow Rate)	VB	—	Vacuum Breaker
LG	—	Less Grid Strainer	WC	—	White with Chrome Finish
LHP	—	Less Handle Program	WCH	—	With Clear Knob Handles
LPU	—	Less Pop-Up, e.g. 540-WFLPU	WF	—	With Fittings—1/2" IPS Adapters
LSP	—	Less Spout	WH	—	White Finish or Trim
MB	—	Matte Black Finish or Mini-Bulk (See MBS)	WP	—	White with <i>Brilliance</i> ® Polished Brass Finish
MC	—	Matte Chrome	WS	—	With Screwdriver Stops

*Accessories (towel bars, etc.) are traditional finish. PB parts marked discontinued may also be traditional finish.

Notes / Notas

Handle & Handle Accent Suffix Designation Chart

No Suffix	Chrome	CW	Chrome/White	PK	<i>Brilliance</i> ® Polished Brass/Oak
AC	Almond/Chrome	GN	Astro Green	PN	<i>Brilliance</i> ® Polished Nickel
AL	Almond	MC	Matte Chrome	PW	<i>Brilliance</i> ® Polished Brass/White
AP	Almond/ <i>Brilliance</i> ® Polished Brass	MS	Colorado Mist	RB	Venetian Bronze™
BS	Biscuit	NC	<i>Brilliance</i> ® Pearl Nickel/Chrome	RD	Vreeland Red
BL	Matte Black	NN	<i>Brilliance</i> ® Pearl Nickel	SS	<i>Brilliance</i> ® Stainless
BU	sPacific Blue	NP	<i>Brilliance</i> ® Pearl Nickel/ <i>Brilliance</i> ® Polished Brass	WC	White/Chrome
CA	Chrome/Almond	OK	Oak	WH	White
CB	Chrome/ <i>Brilliance</i> ® Polished Brass	OR	Orange Spice	WP	White/Polished Brass
CK	Chrome/Oak	PB	<i>Brilliance</i> ® Polished Brass	WW	Whitewash (Pickle)
CL	Clear				ZP	Zin Purple

The perfect Delta[®] faucet is just a click away.

Still can't find what you need? Here's another way to go at it: visit our Web site at www.deltafaucet.com. Look for "Customer Service", where you can access

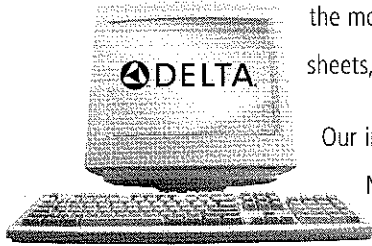

the most current maintenance and installation sheets, specification sheets, and parts diagrams. All with the click of a mouse.

Our interactive site includes an Online Catalog, New Product News, Remodeling Center and a Trade Services section. Plus, information on Where to Buy, frequently asked questions and complete details on the Delta Lifetime Faucet and Finish Limited Warranty.

Questions? We're here to help. Call **1-800-345-DELTA (3358)**.

 **DELTA**[®]
Beautifully Engineered.[™]
A Masco Company

Delta Faucet Company

55 E. 111th St., P.O. Box 40980, Indianapolis, IN 46280
Phone (317) 848-1812
www.deltafaucet.com

Delta Faucet Canada

395 Matheson Blvd. East, Mississauga, Ontario L4Z 2H2

