

COMMERCIAL CATALOG & PRICE BOOK



Effective
09.01.2023

2023/2024

PROGRESSIVE, WATER-SAVING SOLUTIONS FOR PUBLIC SPACES.



At Delta Faucet Company, commercial innovation comes in many forms. From heavy-duty vandal-resistant products to touchless technologies that help promote cleaner environments, to products that use precious resources more efficiently—our lineup offers it all. We are proud to be an EPA WaterSense® Partner, with an ongoing commitment to developing designs which pair convenient water-savings with maximum performance.

HOW TO USE THIS BOOK.

Look for these icons throughout the catalog to easily identify key features of our commercial products.



= Proximity® Sensing Technology



= H₂Optics® Sensing Technology



= DIAMOND™ Valve



= H₂Okinetic® Technology



= WaterSense® Labeled Product (Faucets and Shower Heads)



= WaterSense® Labeled Product (Flush Valves)



= Water-Efficient Product

Kitchen Faucets: flow rate of 1.5 or 1.8 gpm versus Industry Standard ASME A112.18.1/CSA B125.1 of 2.2 gpm.

Lavatory Faucets: flow rate of 1.2 gpm or lower versus Industry Standard ASME A112.18.1/CSA B125.1 of 2.2 gpm.

Flush Valves: water closet valves of 1.1 or 1.27 gpf versus Industry Standard ASSE 1037/ASME A112.1037/CSA B125.37 of 1.6 gpf, urinal valves of 0.5 or 0.125 gpf versus Industry Standard of 1.0 gpf.

Shower Heads and Hand Showers: flow rate of 1.5, 1.75 or 2.0 gpm versus Industry Standard ASME A112.18.1/CSA B125.1 of 2.5 gpm.



= ADA-Compliant Product

WaterSense® and the WaterSense logo are registered trademarks of the U.S. Environmental Protection Agency.
LEED® is a registered trademark of the U.S. Green Building Council.
Agion® is a registered trademark of Sciescent, LLC.
Celcon® is a registered trademark of CNA Holdings, LLC.
Tygon® liner is a registered trademark of Saint-Gobain Performance Plastics.

TECHNOLOGICAL INNOVATIONS 4

LAVATORY FAUCETS

Electronic Lavatory Faucets with Proximity® Sensing Technology	8
Solar Electronic Lavatory Faucets	9
Thermostatic Electronic Lavatory Faucets . .	10
DEMD Electronic Lavatory Faucets	11
H ₂ Optics® Electronic Lavatory Faucets	12
Single Handle	13
Metering	14
Two Handle	16

FLUSH VALVES

Electronic	18
Solar/Specialty/Manual	20

HEALTHCARE

Surgeon Scrub Up	24
General Surgeon Scrub Up	25
Low-Profile Institutional Products	26
Laboratory	27

UNIVERSAL DESIGN

Single Handle General Sink Faucets	28
Two Handle General Sink Faucets	30
Wall Mount General Sink Faucets	32

SHOWERING SOLUTIONS

MultiChoice® Universal	34
Tub & Showers	36
Shower Heads	38

DRAINAGE 40

PRICE BOOK 43

WARRANTY C152

WEB C155

TECHNOLOGIES THAT MAKE A DIFFERENCE.



PROXIMITY[®] SENSING TECHNOLOGY

With Proximity[®] Sensing Technology, the entire faucet body acts as a sensor, activating water flow when hands approach and stopping once hands are removed. The reliable hands-free activation responds extremely fast regardless of lighting, reflections, or direction of approach.

H₂OPTICS® SENSING TECHNOLOGY

Delta® Commercial electronic faucets and flush valves with H₂Optics® Sensing Technology operate consistently, overcoming such factors as dark clothing or lighting conditions. They're also water efficient,* contributing to LEED® certification.

BATTERY BACKUP FOR HARDWIRE-OPERATED ELECTRONICS

Battery backup allows hardwire and plug-in units to continue operating during power outages by switching the supply to a battery until power is restored. Available for use with a wide variety of our electronic faucets and flush valves.

*Water-Efficient Product—Lavatory faucets: flow rate of 1.2 gpm versus Industry Standard ASME A112.18.1/CSA B125.1 of 2.2 gpm. Flush valves: water closet flush valves flow rate of 1.1 or 1.27 gpf and urinal flush valves of 0.5 gpf versus Industry Standard of 1.0 gpf.

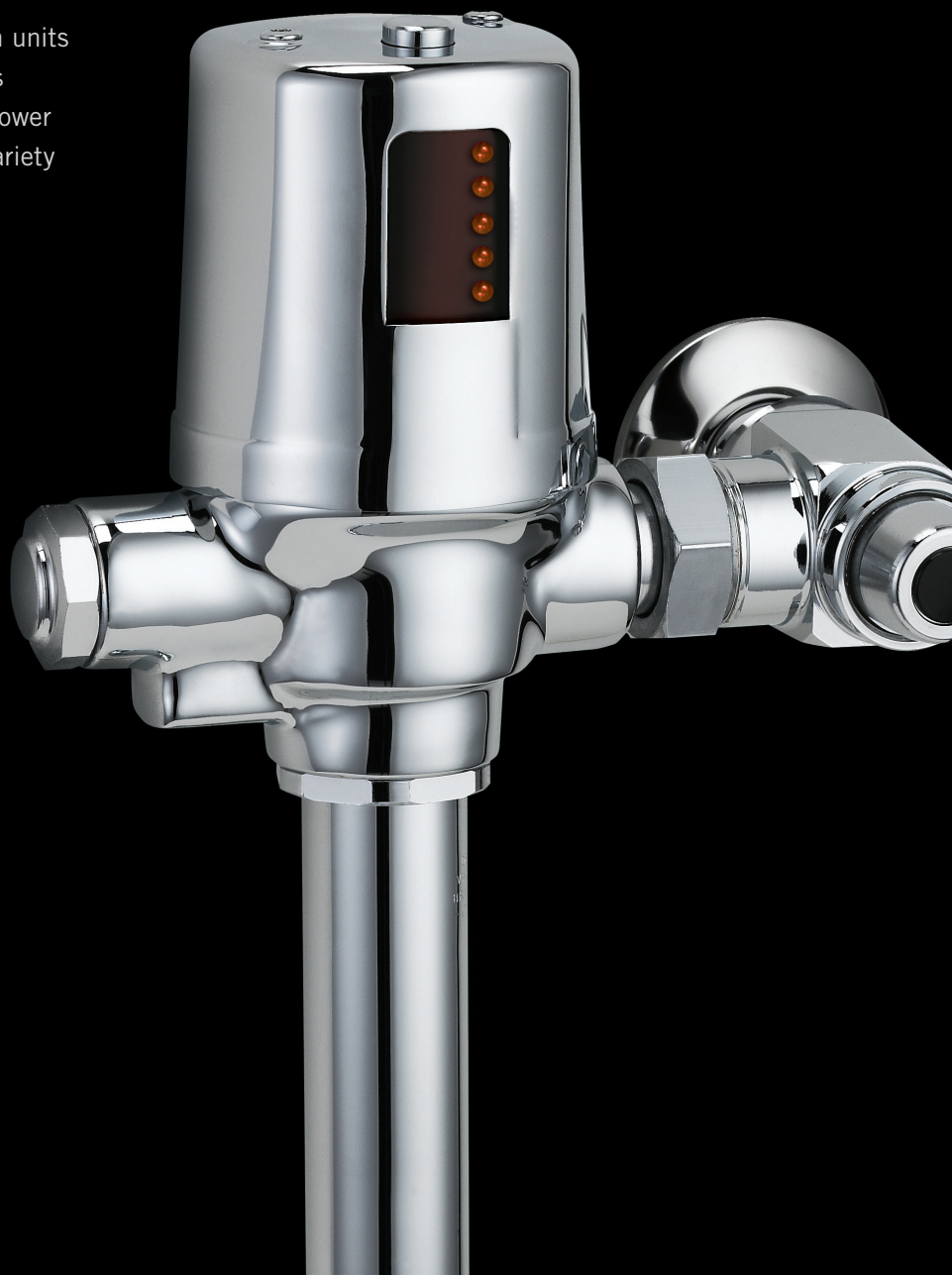

SOLAR TECHNOLOGY

Delta® Commercial solar electronic faucets and flush valves feature top-mounted solar energy modules that harness ambient light energy to assist the batteries in operation of the unit. This allows the faucet or flush valve to respond quickly and reliably in natural, artificial, minimal and occupancy lighting—or none at all.



EZ ADJUST®

A simple turn of an external adjustment screw is all that is needed to set or fine tune flush volumes. There is no need to turn off water supply lines or replace internal parts to adjust flow rates. EZ Adjust® technology allows Delta® Commercial flush valves to have a consistent performance on a broad assortment of fixtures.

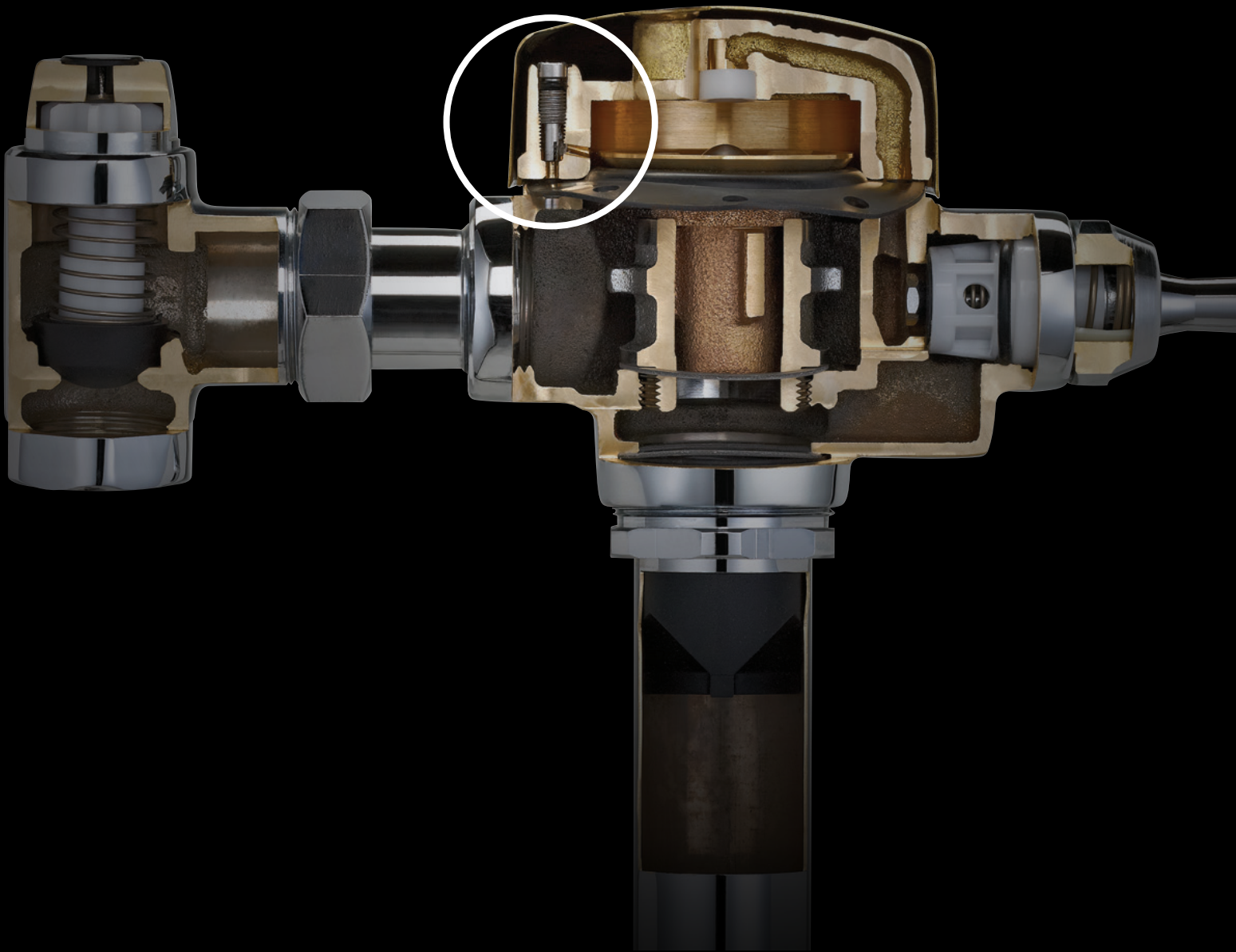



Single-Hole Single-Inlet
Gooseneck Faucet with
Proximity® Sensing Technology
620TPA3320



- 24 VAC to 6 VDC
- Hardwire operation
- Cast brass body
- 1.5 gpm vandal-resistant laminar outlet
- Surface-mounted control box
- Field adjustment of electrical sensitivity
- Models also available with additional outlets, 10" recessed boxes and Brilliance® Stainless and Matte Black finishes
- Optional 4" cast coverplate
- AC filter required—order separately
- Transformer required—order separately
- Available as battery-operated model



Single-Hole Single-Inlet
High-Rise Faucet with
Proximity® Sensing Technology
590TPA0120



- 24 VAC to 6 VDC
- Hardwire operation
- Cast brass body
- 1.5 gpm vandal-resistant laminar outlet with Agion® antimicrobial outlet
- Surface-mounted control box
- Field adjustment of electrical sensitivity
- Optional 8" and 4" coverplates, 10" recessed boxes, and additional outlets
- AC filter required—order separately
- Transformer required—order separately
- Available as battery-operated model



620TPA3320-BL



3-Hole Single-Inlet
4" Centerset Faucet with
Proximity Sensing Technology
591TPA0250



- 24 VAC to 6 VDC
- Hardwire operation
- Cast brass body
- 0.5 gpm vandal-resistant laminar outlet
- Surface-mounted control box
- Field adjustment of electrical sensitivity
- Models also available with additional outlets and 10" recessed boxes
- AC filter required—order separately
- Transformer required—order separately
- Available as battery-operated model



Driftex™ Collection
Electronic Faucet with
Proximity® Sensing Technology
810DPA20



- Architectural™ Design Series
- Hardwire operation
- Adjustable sensing range and timeout
- Control box options: surface mount and recessed mount trim
- Metal hold-down package
- Serviceable filter screen upstream of the valve
- 1.0 gpm flowrate. Available in 0.5 gpm and 0.35 gpm
- Supplied with 3 outlet options (laminar, aerated, and MIKADO spray)
- 810DPA20-SD: Includes matching electronic soap dispenser (coming Q1 2024)
- Available as battery-operated model



Contrasta™ Collection
Electronic Faucet with
Proximity® Sensing Technology
820DPA20



- Architectural™ Design Series
- Hardwire operation
- Adjustable sensing range and timeout
- Control box options: surface mount and recessed mount trim
- Metal hold-down package
- Serviceable filter screen upstream of the valve
- 1.0 gpm flowrate. Available in 0.5 gpm and 0.35 gpm
- Supplied with 3 outlet options (laminar, aerated, and MIKADO spray)
- 820DPA20-SD: Includes matching electronic soap dispenser (coming Q1 2024)
- Available as battery-operated model



Rustica™ Collection
Electronic Faucet with
Proximity® Sensing Technology
830DPA20



- Architectural™ Design Series
- Hardwire operation
- Adjustable sensing range and timeout
- Control box options: surface mount and recessed mount trim
- Metal hold-down package
- Serviceable filter screen upstream of the valve
- 1.0 gpm flowrate. Available in 0.5 gpm and 0.35 gpm
- Supplied with 3 outlet options (laminar, aerated, and MIKADO spray)
- 830DPA20-SD: Includes matching electronic soap dispenser (coming Q1 2024)
- Available as battery-operated model

Hardwire models require AC filter (063271A) and Transformer (060704A); order separately. Hardwire models shown on this page are available with battery backup. Order separately for surface mount box (063268A) or for recessed boxes (063269A).

Mixing valve required; mechanical mixer (R2910-MIXLF) or thermostatic mixer (R3270-MIXLF).



DEMD-320LF



Single-Hole Solar Lavatory Faucet
DEMD-320LF

  Valve activation only.

- Solar-powered with battery assist
- Above-deck electronics and battery pack (4 AA)
- Standard infrared sensing with 6"-8" range
- 0.5 gpm vandal-resistant spray outlet
- Batteries required and included



Single-Hole Solar Lavatory Faucet
with Side Mixer
DEMD-321LF

  Valve activation only.

- Solar-powered with battery assist
- Above-deck electronics and battery pack (4 AA)
- Non-removable side mixer to adjust water temperature
- Standard infrared sensing with 6"-8" range
- 0.5 gpm vandal-resistant spray outlet
- Batteries required and included



DEMD-320, DESD-750



Single-Hole Faucet with
Thermostatic Mixing Valve
DEMD-611LF – 0.66 gpm (0.17 gal/cycle)*
DEMD-611-10LF – 1.0 gpm (0.25 gal/cycle)*

 Valve activation only.

- Battery operated, batteries included
 - ASSE 1070-compliant
 - Above-deck mixing valve and electronics
 - Standard infrared sensing
 - Integrated supply lines
 - Single-hole installation
 - Mixing handle to adjust temperature
 - Adjustable comfort limit stop
 - Optional 4" coverplate
- Note: Will be discontinued Dec. 31, 2023
Not available in California



Single-Inlet Wall Mount Faucet
DEMD-402LF – 8" spout
DEMD-404LF – 6" spout



- 24 VAC to 9 VDC
 - Adjustable maximum run time
 - Pre-mixed water
 - Hardwire operation
 - Adjustable sensor range
 - Standard infrared sensing
 - Remote control available (060967A)
 - 0.5 gpm outlet
- Note: Will be discontinued Dec. 31, 2023
Not available in California

*Based on 15 second max. run time.



Single-Hole Faucet
DEMD-301LF



- Battery operation
 - Pre-mixed water
 - Standard infrared sensing
 - Adjustable maximum run time
 - Adjustable sensor range
 - Optional 4" coverplate available
 - Hardwire kit available for field conversion
 - Remote control available (060967A)
 - 0.5 gpm with vandal-resistant wrench flat spray outlet
- Note: Will be discontinued Dec. 31, 2023
Not available in California



Single-Hole Faucet
DEMD-201LF



- Battery operation
 - Above-deck electronics
 - Pre-mixed water
 - 0.5 gpm with vandal-resistant flat spray outlet
 - Standard infrared sensing
- Note: Will be discontinued Dec. 31, 2023
Not available in California



Single-Hole Faucet
DEMD-101LF



- Battery operation
 - Above-deck solenoid and battery
 - Pre-mixed water
 - 0.5 gpm with vandal-resistant wrench flat spray outlet
 - Standard infrared sensing
- Note: Will be discontinued Dec. 31, 2023
Not available in California



Single-Hole Dual-Inlet Faucet with Side Mixer
DEMD-311LF

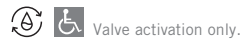

- Valve activation only.
- Battery operation
 - Non-removable side mixer to adjust water temperature
 - Standard infrared sensing
 - Adjustable maximum run time, sensor range
 - Optional 4" coverplate available
 - Hardwire kit available for field conversion
 - Remote control available (060967A)
 - 0.5 gpm with vandal-resistant wrench flat spray outlet
 - Model with technician's mixer (removable side mixer) to adjust temperature: DEMD-112LF
- Note: Will be discontinued Dec. 31, 2023
Not available in California



Single-Hole Dual-Inlet Faucet with Side Mixer
DEMD-211LF



- Valve activation only.
- Battery operation
 - Above-deck electronics
 - Non-removable side mixer to adjust water temperature
 - 0.5 gpm with vandal-resistant flat spray outlet
 - Standard infrared sensing
 - Model with technician's mixer (removable side mixer) to adjust temperature: DEMD-112LF
- Note: Will be discontinued Dec. 31, 2023
Not available in California



Single-Hole Dual-Inlet Faucet with Side Mixer
DEMD-111LF



- Valve activation only.
- Battery operation
 - Above-deck solenoid and battery
 - Non-removable side mixer to adjust water temperature
 - 0.5 gpm with vandal-resistant wrench flat spray outlet
 - Standard infrared sensing
 - Model with technician's mixer (removable side mixer) to adjust temperature: DEMD-112LF
- Note: Will be discontinued Dec. 31, 2023
Not available in California



Single-Hole Electronic Soap Dispenser
DESD-750 – Plug-in
DESD-751 – Battery
DESD-751-BL – Battery (Matte Black)



- Cast brass body
- Standard 1000 ml refillable soap bottle
- Standard infrared sensing
- Fits on decks up to 2" thick
- Blue LED indicator for low soap
- Plug-in kit available for field conversion

Responsive and Efficient

With a response time of four pulses per second, H₂Optics® Sensing Technology balances reaction time and battery conservation.



590TF1120



Single-Hole Single-Inlet High-Rise Faucet with H₂Optics® Technology
590TF1120



- Cast brass body
 - Battery operation
 - 1.5 gpm vandal-resistant laminar outlet
 - Surface-mounted control box
 - Optional 8" and 4" coverplates
 - 10" recessed box available
 - Adjustable sensing range and maximum run time
 - Models also available with hardwire operation and additional outlets
- Note: Available in Q4 2023



3-Hole Single-Inlet 4" Centerset Faucet with H₂Optics® Technology
591TF1220



- Cast brass body
 - Battery operation
 - 1.5 gpm vandal-resistant laminar outlet
 - Surface-mounted control box
 - 10" recessed box available
 - Adjustable sensing range and maximum run time
 - Models also available with hardwire operation and additional outlets
- Note: Available in Q4 2023



Single-Hole Single-Inlet Faucet with H₂Optics® Technology
590-TFLGHGMHDF



- Metal construction
- Battery operation
- 0.5 gpm vandal-resistant laminar outlet
- No external adjustments required
- Model with 4" coverplate: 591-TFLGHGMHDF

Ceramic Disc Technology

Smooth operation makes this washerless faucet low-maintenance. The volume and temperature control is integrated so the faucet can be turned on in the same position as it was turned off for consistent temperature setting.



22C101



Single-Hole Faucet
22C631



- Cast brass body
- Vandal-resistant lever handle and 1.5 gpm outlet
- Ceramic cartridge with rotational limit stop to limit turning of the handle into hot zone
- 0.5 gpm available: 22C651



4" Centerset Faucet
22C131 – Less pop-up (no hole)
22C331 – With metal pop-up



- Cast brass body
- Vandal-resistant lever handle and vandal-resistant 1.5 gpm flow control outlet
- Ceramic cartridge with rotational limit stop to limit turning of the handle into hot zone



4" Centerset Faucet
501LF-HGMHDF



- Vandal-resistant lever handle and 0.5 gpm outlet
- Adjustable handle limit stop
- DIAMOND™ Valve
- 0.35 gpm available: 501LF-TGMHDF



4" Centerset Faucet
515LF-HDF



- Includes metal pop-up
- Vandal-resistant 6" elbow handle and 1.2 gpm outlet
- Adjustable handle limit stop
- DIAMOND™ Valve



Single-Hole Faucet
701LF-HDF



- Vandal-resistant push-style handle and outlet
- Adjustable close time



Widespread Single Control Faucet
24T2643



- Vandal-resistant 6" lever handle
- 4" to 16" adjustable centers
- 1.5 gpm outlet
- Stainless steel ball

For additional information on the models shown here, as well as other available models, please go to www.deltafaucet.com/commercial.

ADA Tip Action Lever Handles

Offer ease of use and meet ADA standards—a feature not typically offered in metering faucets.

Water-Efficient Outlet

Comes standard with a 0.5 gpm flow rate. Each handle is set not to exceed a flow of 0.25 gallons per activation.





Single-Hole Faucet
87T104



- Cache outlet available
- Cast brass body
- Vandal-resistant push-style handle
- Adjustable close time



Single-Hole Faucet
87T105



- Cache outlet
- Cast brass body
- Vandal-resistant tip action lever handle
- Adjustable close time
- Model including mixing tee and inlet checks available: 87T111



4" Centerset Faucet
86T1153



- Cast brass body
- Vandal-resistant tip action lever handles and outlet
- Adjustable close time



4" Centerset Faucet
2507LF-HDF



- Vandal-resistant push-style handles and outlet
- Adjustable close time

Smooth-End Spout

This maintenance-free laminar flow outlet has the flow control located in the base of the spout, and the chrome-plated smooth end eliminates crevices where bacteria can form.





4" Center set Faucet
21C143



- Cast brass body
- Vandal-resistant 3" hooded lever handles
- CER-TECK® ceramic disc cartridge
- 1.5 gpm outlet



4" Center set Faucet
21C142



- Cast brass body
- Vandal-resistant 4" hooded blade handles
- CER-TECK® ceramic disc cartridge
- 1.5 gpm outlet



4" Center set Faucet
2529LF-LGHGMHDF



- Vandal-resistant wrist blade handles
- 0.5 gpm outlet



6"-12" Widespread Faucet
23C333



- Vandal-resistant 3" hooded lever handles
- CER-TECK® ceramic disc cartridge
- 1.5 gpm outlet



6"-12" Widespread Faucet
23C342



- Vandal-resistant 3" hooded blade handles
- CER-TECK® ceramic disc cartridge
- 1.5 gpm outlet



6"-16" Widespread Faucet
3549LF-WFLGHDF



- Vandal-resistant wrist blade handles
- Vandal-resistant aerator
- 1.2 gpm outlet



6"-12" Widespread Faucet
23C674



- Vandal-resistant 4" blade handles with sanitary hood
- CER-TECK® ceramic disc cartridge
- Laminar flow control smooth-end spout (1.0 gpm)



6"-12" Widespread Faucet
23C632



- Vandal-resistant 4" hooded blade handles
- CER-TECK® ceramic disc cartridge
- 1.5 gpm outlet



6"-16" Widespread Faucet
3579LF-WFLGHDF



- Vandal-resistant wrist blade handles
- 1.2 gpm outlet
- Rigid gooseneck spout

For additional information on the models shown here, as well as other available models, please go to www.deltafaucet.com/commercial.

Easy to Install and Adjust

Right out of the box, the batteries are already installed and setup is a breeze with adjustable settings.

Vandal-Resistant

All metal heavy-duty construction. Chloramine-resistant diaphragm.

Cost-Effective, Hands-Free Upgrade for Your Manual System

Retrofit an electronic flush valve onto an existing manual unit with a simple kit.

Sloan® / Zurn® stop retrofit models

Retrofit to an existing Sloan® or Zurn®.





Exposed Electronic Urinal Flush Valve
81T231HWA – Hardwire
81T231BTA – Battery



- Featuring H2Optics® Sensing Technology
- Chloramine-resistant diaphragm
- Electronic override button
- Scratch-resistant replaceable lens window
- Factory set to 0.5 gallon flush—field adjustable
- 81T231BTA-MMO: Battery-operated with manual mechanical override option
- Also available in Matte Black with Chrome finish



Exposed Electronic Water Closet Flush Valve
81T201HWA – Hardwire
81T201BTA – Battery



- Featuring H2Optics® Sensing Technology
- Chloramine-resistant diaphragm
- Electronic override button
- Scratch-resistant replaceable lens window
- Factory set to 1.6 gallon flush—field adjustable
- 81T201BTA-MMO: Battery-operated with manual mechanical override option
- 81T201BTA-42-MMO: Battery-operated with manual mechanical override; 1.1 gallon fixed flush volume
- 81T201HWA-42-MMO: Hardwire with manual mechanical override; 1.1 gallon fixed flush volume
- Also available in Matte Black with Chrome finish



Exposed Electronic Flush Valves with Wall Mount Sensors
81T201-48-WMSHWA – Hardwire (water closet)
81T231-WMSHWA – Hardwire (urinal)



- Featuring H2Optics® Sensing Technology
- Chloramine-resistant diaphragm
- Electronic manual override button
- Vandal-resistant stainless steel cover
- Factory set to 1.27 gallon flush for water closets and 0.5 gallon flush for urinals—field adjustable
- -48 models not field adjustable
- Only 81T201-48-WMSHWA is WaterSense® labeled



Concealed Electronic Washdown Urinal Flush Valve
1600T9001RI – Rough-in (hardwire)
1600T9001TR – Trim (hardwire)



- Featuring H2Optics® Sensing Technology
- Electronic manual override button
- Vandal-resistant stainless steel cover
- Available in various rough-in and trim options
- Factory plumbed for easy installation
- Factory set to 0.5 gallon flush—field adjustable

Note: Model must be installed on fixtures providing sufficient air gap protection against backflow.



Concealed Electronic Flush Valve for Wall-Hung Water Closet
1600T6102ARI – Rough-in (hardwire)
1600T6102ATR – Trim (hardwire)



- Featuring H2Optics® Sensing Technology
- Electronic manual override button
- Water closet and urinal models available
- Vandal-resistant stainless steel cover
- Available in various rough-in and trim options
- Factory plumbed for easy installation
- Factory set to 1.6 gallon flush—field adjustable



Concealed Electronic Flush Valve for Wall-Hung Water Closet
1600T6103ARI – Rough-in (hardwire)
1600T6103ATR – Trim (hardwire)



- Featuring H2Optics® Sensing Technology
- Electronic manual override button
- Water closet and urinal models available
- Vandal-resistant stainless steel cover
- Available in various rough-in and trim options
- Factory plumbed for easy installation
- Factory set to 1.6 gallon flush—field adjustable



Side Mount Electronic Flush Kit
DEFM-100



- Retrofit model
- Battery operation
- For use on 81T Teck® exposed manual flush valves and 86T flush valves for washdown urinals
- Compatible with multiple brands
- Standard infrared sensing
- Courtesy manual flush button



Electronic Flush Retrofit Kit for Sloan®/Zurn® stop
81T201BTA-30-MMO – Battery (water closet)
81T231BTA-30-MMO – Battery (urinal)



Valve activation only.

- Retrofit model for Sloan®/Zurn® stop
- Featuring H2Optics® Sensing Technology
- Complete valve less stop, cover tube and wall flange
- Chloramine-resistant diaphragm
- Electronic override button
- Battery-operated with manual mechanical override option
- Scratch-resistant replaceable lens window
- Factory set to 1.6 gallon flush for water closets and 0.5 gallon flush for urinals—field adjustable

Hardwire models shown on this page are available with battery backup; order 061047A separately.

For additional information on the models shown here, as well as other available models, please go to www.deltafaucet.com/commercial.



Features of the Delta® Commercial Solar Flush Valve:

- Solar-powered with battery assist
- Hands-free operation
- Push-button mechanical override
- Optional 24-hour auto flush





Solar Exposed Water Closet Flush Valve
81T201SP-MMO (not WaterSense® labeled)
☼ 81T201SP-42-MMO; ☼ 81T201SP-48-MMO



Valve activation only.

- Solar-powered with battery assist
- Hands-free operation
- Push-button mechanical override
- For 1-1/2" top inlet water closet fixture
- Optional 24-hour automatic flush, factory set to OFF
- 81T201SP-MMO: Factory set to 1.6 gpf*
- 81T201SP-42-MMO: Factory set to 1.1 gpf
- 81T201SP-48-MMO: Factory set to 1.27 gpf
- Batteries required and included



Solar Exposed Urinal Flush Valve
81T231SP-MMO (not WaterSense® labeled)
☼ 81T231SP-05-MMO; ☼ 81T231SP-19-MMO



Valve activation only.

- Solar-powered with battery assist
- Hands-free operation
- Push-button mechanical override
- For 3/4" top inlet urinal fixture
- Optional 24-hour automatic flush, factory set to OFF
- 81T231SP-MMO: Factory set to 0.5 gpf*
- 81T231SP-05-MMO: Factory set to 0.125 gpf
- 81T231SP-19-MMO: Factory set to 0.5 gpf
- Batteries required and included



Water Closet Flush Valve
81T201



- Chloramine-resistant diaphragm
- ADA vandal-resistant non-hold open handle
- 81T201: Factory set to 1.6 gpf—field adjustable
- 81T201-30: Retrofit model for Sloan®/Zurn® stop
- 81T201-42 and 81T201-542: Factory set to 1.1 gpf



Urinal Flush Valve
81T231



- Chloramine-resistant diaphragm
- ADA vandal-resistant non-hold open handle
- Factory set to 0.5 gpf—field adjustable
- 81T231-30: Retrofit model for Sloan®/Zurn® stop



Flush Valve for Washdown Urinal
86T505



- ADA vandal-resistant handle
- Back inlet stop for 1/2" supply
- Factory set to 0.5 gpf—field adjustable

Note: Model must be installed on fixtures providing sufficient air gap protection against backflow.



Electronic Washdown Urinal Flush Valve
DEMD-86505



- Battery operation
- Standard infrared sensing
- Adjustable sensor range
- Remote control available
- Factory set to 0.5 gpf—field adjustable with optional remote

Note: Model must be installed on fixtures providing sufficient air gap protection against backflow.

*Field adjustable—EZ Adjust™ screw allows flush to be adjusted without shutting off water supply.

For additional information on the models shown here, as well as other available models, please go to www.deltafaucet.com/commercial.

BECAUSE OUR PRODUCTS DO THEIR JOB, YOU'RE FREE TO CONCENTRATE ON YOURS.

Successful healthcare depends on reliable tools. Delta® Commercial offers a broad range of products for the industry—and we're always designing new innovations, to offer professionals even more convenience.





PHARMACEUTICALS



1500T3370



Electronic Wall Mount Faucet Trim
1500TF4628TR



- Wall mount rigid gooseneck spout with integral sensor in base
- Adjustable sensing range and time out
- Hardwire operation
- Smooth-end spout with 1.5 gpm laminar flow control outlet
- Must order rough-in: ELAVT0008ARI or ELAVT0001ARI
- Available in Q4 2023



Electronic Deck Mount Faucet
1501TF3320



- Rigid gooseneck spout with integral sensor in base
- Adjustable sensing range and time out
- Battery operation
- 1.5 gpm vandal-resistant laminar outlet
- 4" and 8" coverplates available for order
- Available in Q4 2023



3-Position Switch
(060651A for use with H₂Optics® Sensing Technology and Proximity® Sensing Technology Lavatory Products)

- Designed so healthcare facilities can continue to follow infectious control procedures.

Switch Settings

- ON – Solenoid goes into continuous run so water lines can be flushed with high-temperature water.
– Refer to specific product specification sheets as higher temperatures may damage sensor components.
- AUTO – Faucet functions according to regular settings.
- OFF – Solenoid is blocked from operating so cleaning staff can clean sink without faucet operating.

General Surgeon Scrub Up



Surgeon Scrub Faucet
54T5432A



- Floor mount self-close double foot pedal valve
- Deck mount rigid/swivel gooseneck spout
- Vandal-resistant 1.5 gpm laminar with Agion® antimicrobial outlet



Surgeon Scrub Faucet
54T5332A



- Wall mount self-close double foot pedal valve
- Deck mount rigid/swivel gooseneck spout
- Vandal-resistant 1.5 gpm laminar with Agion® antimicrobial outlet

Hardwire models shown on this page are available with battery backup; order 061047A separately. Hardwire models require Transformer (060704A); order separately.

An electronic product that provides leading functionality—combining ease of use and ADA compliance while maintaining a sleek, low-profile design.



Push-Button Electronic Shower System
860T178



- Recessed metal box mount with thermostatic mixing valve
- Field adjustable shower time
- 30° vandal-resistant forged shower head
- Hardwire operation
- 1.5 gpm shower head
- Transformer required, order separately

Hardwire models shown on this page are available with battery backup; order 061047A separately. Hardwire models require Transformer (060704A); order separately.



W6635DW

Services available for ball valves:

- Air
- Cold Water
- Natural Gas
- Vacuum



Single Shank Deck Mount
Mixing Faucet
W6760-9

- Dual-check in-line vacuum breaker
- 1/4" I.D. 10 serrated nozzle outlet
- Maximum 1.5" diameter deck hole



Deck Mount Mixing Faucet
W6700-9

- Dual-check in-line vacuum breaker
- 1/4" I.D. 10 serrated nozzle outlet
- 2-hole installation at 2.75" centers



Single Deck Mount Water Faucet
W6600-10

- Angle atmospheric vacuum breaker
- 1/4" I.D. 10 serrated nozzle outlet
- Maximum 1.25" diameter deck hole



Deck Mount Turret
W6210GAS



- Single ball valve in deck mount turret
- Available in various configurations and services



Deck Mount Turret
W6220GAS



- Two ball valves at 90° in deck mount turret
- Available in various configurations and services



Pure Water Faucet
W6635DW

- Self-close Celcon® valve
- Gooseneck spout with Tygon® liner



Adjustable Handle Limit Stop
Limits the movement of the handle into the “hot” zone.

ADA-Compliant Lever Handle
Allows you to carry a stylish design throughout your entire facility.

DIAMOND™ Valve
Embedded with diamonds for incredible durability, and designed and tested to perform like new for life.





Single-Lever Kitchen Faucet
100LF-HDF



- Vandal-resistant elbow handle and 1.5 gpm outlet
- Swivel spout
- 3-hole installation
- Adjustable handle limit stop
- DIAMOND™ Valve



Single-Lever Kitchen Faucet
101LF-HDF



- Vandal-resistant elbow lever handle and 1.5 gpm outlet
- Swivel spout
- Single-hole installation
- Adjustable handle limit stop
- DIAMOND™ Valve



8" Deck Mount Single-Lever Kitchen Faucet
400LF-HDF



- Matching finish side sprayer
- Vandal-resistant elbow lever handle and 1.5 gpm outlet
- 4-hole installation
- Adjustable handle limit stop
- DIAMOND™ Valve



Single-Lever Utility Faucet
710LF-HDF



- Vandal-resistant elbow handle and 1.5 gpm outlet
- 10"-high rigid spout
- 2-hole installation
- Adjustable handle limit stop
- DIAMOND™ Valve



Single-Lever Pantry Faucet
27C643



- Vandal-resistant lever handle
- 1.5 gpm outlet
- Single-hole installation
- Rigid/swivel gooseneck spout
- CER-TECK® ceramic disc cartridge

Water-Efficient Outlet

Available in five optional reduced flow outlets, ranging from 0.5 gpm to 1.5 gpm.

Rigid/Swivel Gooseneck Spout

Optional brass collar is supplied to accommodate rigid or swivel installation needs. Limited swing also available.

DELTA
®





8" Cast Deck Mount Faucet
26C3944



- Vandal-resistant 4" blade handles with sanitary hood
- 3-hole installation
- 1.5 gpm outlet
- Rigid/swivel gooseneck spout
- CER-TECK® ceramic disc cartridge



Single Shank Mixing Faucet
25C3847



- Vandal-resistant 2-1/2" balanced lever handles
- Single-hole installation
- 1.5 gpm outlet
- Rigid/swivel gooseneck spout
- CER-TECK® ceramic disc cartridge



8" Below Deck Mount Faucet
27C2923



- Vandal-resistant 3" hooded lever handles
- 3-hole installation
- Vandal-resistant 1.5 gpm laminar with Agion® antimicrobial outlet
- Rigid/swivel gooseneck spout
- CER-TECK® ceramic disc cartridge



4" Cast Deck Mount Faucet
27C4842



- Vandal-resistant 4" hooded blade handles
- 2-hole installation
- 1.5 gpm outlet
- Rigid/swivel gooseneck spout
- CER-TECK® ceramic disc cartridge



8" Center Wall Mount Pre-Rinse Faucet
55C1513



- Vandal-resistant 3" hooded lever handles
- Supplied with standard 1.6 gpm spray outlet and water/energy-saving 1.2 gpm option
- Includes auto shut-off
- CER-TECK® ceramic disc cartridge

ADA Handle Options



- 4" Hooded Blade
(Available with optional red/blue temperature indicator)



- 3" Hooded Lever
(Available with optional red/blue temperature indicator)



- 4" Blade with Sanitary Hood
(Available with optional red/blue temperature indicator—shown above)



- 6" Wrist with Sanitary Hood





Wall Brace

Reinforces the faucet-to-wall connection and helps to support heavy pails of water.

Integral Checks

Eliminate crossflow—preventing the hot water from traveling to the cold side and vice versa.

Integral Stops

Allow for ease of maintenance—no need to shut the entire water supply off when you can do it right at the faucet.

Body-Mounted Vacuum Breaker with Garden Hose End

The vacuum breaker prevents backflow of sink water into potable water system. The standard hose-end spout makes adding and removing garden hoses simple.





8" Center Wall Mount Service Sink Faucet
28C2383



- Cast brass body
- Vandal-resistant 3" hooded lever handles
- Adjustable top/bottom brace
- Body-mounted angle vacuum breaker with garden-hose end
- Includes integral check stops
- CER-TECK® ceramic disc cartridge



8" Center Wall Mount Service Sink Faucet
28C8073



- Cast brass body
- Vandal-resistant 3" hooded lever handles
- Spout end vacuum breaker with garden-hose end
- Includes 48" hose and stainless steel hanger
- Includes integral check stops
- CER-TECK® ceramic disc cartridge



8" Center Wall Mount Service Sink Faucet
28T9

- Cast brass body
- Metal cross handles
- In-line vacuum breaker with garden-hose end
- Includes integral stops
- Compression cartridge
- Model with adjustable centers available: 28T9-AC



8" Center Wall Mount Sink Faucet
28C4434



- 4" blade handles with sanitary hood
- Vandal-resistant 1.5 gpm outlet
- 11" tubular swing spout
- CER-TECK® ceramic disc cartridge



8" Center Wall Mount Service Sink Faucet
28P4402LF



- Cast brass body
- 4" hooded blade handles
- Vandal-resistant 1.5 gpm outlet
- 8" long spout—swings 360°
- Less integral stops



8" Center Wall Mount Service Sink Faucet
28C9LH



- Cast brass body
- 4" metal lever handles
- In-line vacuum breaker with garden-hose end
- 1/4-turn ceramic cartridge
- Includes integral stops

THE DELTA[®] MULTICHOICE[®] UNIVERSAL VALVE

FLEXIBILITY THAT SAVES TIME AND MONEY.

Installing the MultiChoice[®] Universal Valve first makes it easier to change style, finish and functionality later. Because there's no need to alter plumbing behind the wall, you can save time, effort and money on mid-construction changes and renovation updates.

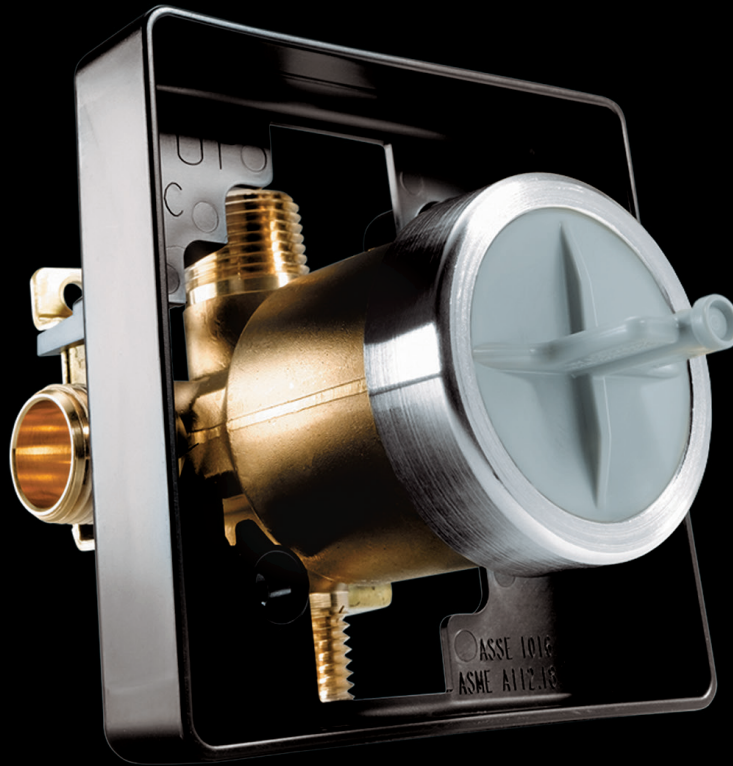

One rough. Unlimited possibilities.

Square Plasterguard

The size of a standard tile allows for simple 90° cuts. Snaps into place with no tools required to remove.

Mounting Bracket

Provides a sturdy method to secure the valve to a stringer and prevents rocking.

R10000-UNWS MultiChoice® Universal Valve Body

WS—with stops recommended for Commercial applications.

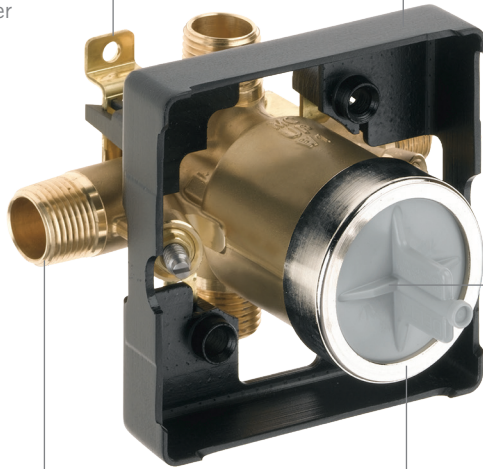

Three Connection Types

Provides universal connection options for every type of piping—IPS, PEX and UNIVERSAL.

Heat-Resistant Pressure Test Cap

Allows for air or water testing up to 300 psi, before the valve cartridge is installed. Easy access for flushing out the system.



Single-Function Pressure-Balanced Valve Cartridge

Functions with a single control for temperature only.



Dual-Function Pressure-Balanced Valve Cartridge

Offers independent control of temperature and volume by balancing the pressure of hot and cold water.



Dual-Function Thermostatic Valve Cartridge

Keeps water temperature consistent by actually measuring and monitoring the temperature of the water and automatically adjusting the water mix to maintain a more precise water temperature.

Adjustable Shower Head

Allows users to select their preference among full, massage and combination settings.



Diverter Valve

Makes it easy for the user to switch between the shower head and hand shower.



MultiChoice® Universal

Provides unparalleled flexibility with multiple cartridge options.



Stainless Steel Bar with ADA Slide

When installed according to spec, this stainless steel bar serves as both a slide bar and an ADA-compliant bar.



Tub and Shower with H₂Okinetic® Shower Head
T13H283 – Trim
R10000-UNWS – Rough-in



- MultiChoice® Universal pressure-balance tub and shower
- H₂Okinetic® water-efficient 1.5 gpm shower head
- Vandal-resistant lever blade handle
- Escutcheon with non-removable red/blue marking



Shower Only
T13H123 – Trim
R10000-UNWS – Rough-in



- MultiChoice® Universal pressure-balance shower
- Touch-Clean® 3-setting 1.75 gpm shower head
- Vandal-resistant lever blade handle
- Escutcheon with non-removable red/blue marking



Tub and Shower
T13H232 – Trim
R10000-UNWS – Rough-in



- MultiChoice® Universal pressure-balance tub and shower
- Touch-Clean® water-efficient 1.5 gpm shower head
- Vandal-resistant lever handle
- Escutcheon with non-removable red/blue marking



Shower Only
T17TH125 – Trim
R10000-UNWS – Rough-in



- TempAssure® thermostatic shower
- Touch-Clean® 3-setting 1.75 gpm shower head
- Tub and shower trim models available
- Vandal-resistant lever handle
- Non-removable red/blue indicators



Hand Shower with Wall Bar
T17TH155 – Trim
R10000-UNWS – Rough-in



- TempAssure® thermostatic shower
- Touch-Clean® 2-setting 2.5 gpm hand shower
- 24" stainless steel bar with ADA adjustable slide
- Vandal-resistant lever handle
- Non-removable red/blue indicators



Tub and Shower
T13490 – Trim
R10000-UNWS – Rough-in



- MultiChoice® Universal pressure-balance tub and shower
- Touch-Clean® 1.75 gpm shower head
- Vandal-resistant lever blade handle
- Red/blue indicators



Tub and Shower with Push-Button Diverter
T13691 – Trim
R10300-UNWS – Rough-in



- MultiChoice® Universal pressure-balance tub and shower
- Touch-Clean® 1.75 gpm shower head
- Integral push-button diverter
- Red/blue indicators



Push-Button Electronic Shower System
860T167 – Hardwire
861T167 – Battery



- Recessed metal box with pressure-balance mixing valve
- 30° vandal-resistant handle and 1.5 gpm shower head
- Available with various mixing and shower head options
- Field adjustable shower time

For additional information on the models shown here, as well as other available models, please go to www.deltafaucet.com/commercial. WaterSense® icons shown on this page apply only to the shower heads within the product grouping.

Vandal-Resistant Design

Cast brass institutional shower head, 30° spray angle from wall.

- Concealed cast brass mounting plate with vandal-resistant front mounting screws.

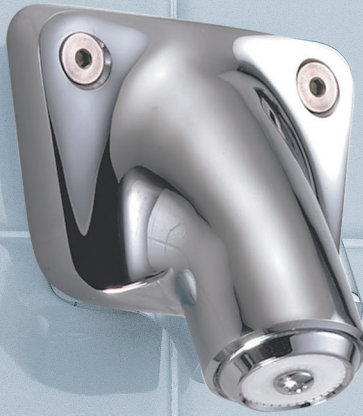



30° Vandal-Resistant Cast
Wall Mount Shower Head
060793A

- 2.0 gpm 

060991A

- 1.75 gpm 

061011A

- 1.5 gpm 



30° Vandal-Resistant Forged Brass Wall
Mount Shower Head
063214A

- 2.0 gpm 

063196A

- 1.5 gpm



Bent Shower Arm and Flange
060710A

- Metal set screw wall flange



Grid Strainer
33T260

- 1-1/4" grid strainer
- Cast brass body
- Overflow holes



Grid Strainer
33T290



- 1-1/4" offset grid strainer
- Cast brass body
- Overflow holes



Cast P-Trap
33T311 – 1-1/4"
33T360 – 1-1/2"

- With cleanout
- Adjustable



Cast P-Trap
33T301

- 1-1/4" cast P trap
- Adjustable
- Less cleanout



DELTA





2023/2024
**COMMERCIAL
PRICE BOOK**
EFFECTIVE 09.01.2023



Delta Faucet Company
www.apexselect.com/main-menu.aspx

DELTA COMMERCIAL INTERNATIONAL FOR PEEK

Products Business and Innovation Support

Commercial Products

Delta understands the unique demands of the commercial market. Our products go beyond excellent design to incorporate smart thinking and exceptional performance that stand the test of time, even in the most challenging environments.

BROWSE BY INDUSTRY

Image 1: Modern kitchen sink with three faucets and green plants.
Image 2: Hospital or clinical setting.
Image 3: Office or laboratory setting.
Image 4: Public space or transit station.

The Delta® Commercial Price Book provides you with the details you need to choose the right product for your commercial application. From lavatory faucets, to flush valves, healthcare specialties, tub/shower, drainage and parts, Delta commercial products offer a variety of plumbing products.

For your convenience, our product selections are divided into two sections, **Quick Pick** and **Model Options**.

Quick Pick (starting at page CV) provides you with a list of our most popular models and is set up to simplify your ordering process.

Model Options (starting at page C43) allows you to select a product to meet your unique commercial needs.

INNOVATIVE SOLUTIONS

Style meets performance with Delta commercial products that not only provide long life, but also enhance their environments. From the beginning, the Delta brand has sought out innovative solutions to help people use water in better ways. These smart features, found across our offerings, are helping to improve the lives of more and more people every day.

Water-Efficient Products

All Delta products that are water-efficient provide a flow rate that's lower than the industry standard. Specific flow rates are noted in the product descriptions.

 **ADA** – some people and some local codes, require fixtures that are compliant with the Americans with Disabilities Act. If someone may visit who has special needs, or if you believe future buyers might appreciate this feature, Delta commercial products offer a range of compliant fixtures.

 **Code-Compliant** – products compliant with State and Federal drinking water legislation.

 Denotes water-efficient products.

H₂Optics® Sensing Technology – a hands-free innovation which accurately senses the user's distance, regardless of external factors such as light reflection, clothing color and textures or dryness of one's skin, providing consistent and dependable results.

Proximity® Sensing Technology – the entire faucet body acts as a sensor, activating the faucet when the user's hand comes within 4" of the spout.

 – **DIAMOND™ Valve** and 3/8" copper supplies with universal fittings (3/8" compression, 3/8" sweat, or 1/2" I.P.S.).

Battery Backup – provides battery power backup for hardwire electronic models; order 063268A for surface mount box and 063269A for recessed box.

Optional Suffixes:

- AC = Adjustable Centers
- BL = Matte Black
- BT = Battery-Operated
- BTA = Battery-Operated
- HGM = 0.5 gpm @ 60 psi flow rate
- HW = Hardwire-Operated
- HWA = Hardwire-Operated
- KS-PR = Lumicoat™ Black Stainless
- LS = Limited Swing Gooseneck Spouts
- NS = Nickel Stainless
- PN-PR = Lumicoat™ Polished Nickel
- PR = Lumicoat™ Chrome
- QD = Quick Disconnect
- R's = Rigid Swivel Spouts
- RI = Rough-In Only
- S's = Swing Spouts
- SS = Brilliance® Stainless Finish
- SS-PR = Lumicoat™ Brilliance® Stainless
- TGM = 0.35 gpm @ 60 psi flow rate
- TI = Temperature Indicators on handles
- TR = Trim Only



Water-Efficient Product (meets CalGreen standards)
 Kitchen Faucets: Flow Rate of 1.8 gpm or 1.5 gpm versus Industry Standard ASME A112.18.1/CSA B125.1 of 2.2 gpm.

Lavatory Faucets: Flow Rate of 1.2 gpm or lower versus Industry Standard ASME A112.18.1/CSA B125.1 of 2.2 gpm.

Shower Heads and Hand Showers: Flow Rate of 1.5 to 2.0 gpm versus Industry Standard ASME A112.18.1/CSA B125.1 of 2.5 gpm.

Tub/Showers: Valve rated at minimum 1.2 gpm (4.5 L/min) for pressure-balance; 1.7 gpm (6.4 L/min) for thermostatic at 45 psi (310 kPa). ASSE.1016/ASME A112.1016/CSA B125.16



WaterSense® Labeled Product
 Lavatory Faucets: Flow Rate of 1.2 gpm or 1.0 gpm versus Industry Standard ASME A112.18.1/CSA B125.1 of 2.2 gpm.

Shower Heads and Hand Showers: Flow Rate of 1.5 or 2.0 gpm versus Industry Standard ASME A112.18.1/CSA B125.1 of 2.5 gpm.



Flush Valves: water closet valves of 1.1 or 1.27 gpf versus Industry Standard ASSE 1037/ASME A112.1037/CSA B125.37 of 1.6 gpf, urinal valves of 0.5 or 0.125 gpf versus Industry Standard of 1.0 gpf.



ADA Single and two handle models displaying this nationally recognized symbol are accessible to and usable by physically challenged persons and meet all the requirements of ICC/ANSI A117.1 and ADAAG for an operable part.

Symbols



FB = Full Body Spray (FB)

P = Pause (P)

M = Massage Spray (M)

SD = Soft Drench Spray (SD)

ELECTRONICS

PROXIMITY® SENSING TECHNOLOGY FAUCETS

590TPA.....	C3, C48
591TPA.....	C3, C52
620TPA to 621TPA.....	C2, C54, C55
810DPA	C136
820DPA	C137
830DPA	C138

H₂OPTICS® SENSING TECHNOLOGY FAUCETS

590-TFLGHGMHDF to	
591-TFHGMHDF.....	C7
ELAVT0001ARI.....	C10, C46, C48, C50, C52, C55, C58
ELAVT0008ARI.....	C10, C47, C49, C51, C53, C55, C58, C136, C137, C138
590TF.....	C8, C46
591TF.....	C8, C50
1500TF3 & 1501TF3.....	C9, C57
1500TF4 & 1501TF4.....	C9, C59

DEMD FAUCETS

DEMD-101LF to	
DEMD-312LF	C4-C5
DEMD-320LF to	
DEMD-321LF	C4
DEMD-402LF to	
DEMD-404LF.....	C6
DEMD-611LF.....	C4

EXPOSED FLUSH VALVES (WC & UR)

81T***BTA.....	C15-C16, C69-C70
81T**MMO.....	C15-C17, C68-C70
81T***HWA.....	C15, C17, C69-C71
81T*** Solar.....	C16, C17, C68
81T201-WMSHWA to 81T231-WMSHWA.....	C17, C71
DEFM-100	C15
DEMD-86505 to DEMD-86515.....	C19

CONCEALED FLUSH VALVES (UR)

1600T6 Series.....	C18, C72-C73
1600T9.....	C19, C74

ACCESSORIES – SOAP DISPENSERS

DESD-750 Series.....	C13
----------------------	-----

ELECTRONIC ACCESSORIES

Plug-in Power Supply/Hardwire AC Filter/ Proximity® Retrofit Kit/ Battery Back-up Assemblies....	C11
Hardwire Converters.....	C11, C12
Transformers	C12, C62
Cover Plates	C14

FLUSH VALVES

MANUAL

81T.....	C64-C65
83T.....	C66-C67
86T5.....	C19, C113

ELECTRONIC

81T***BTA.....	C15-C16, C69-C70
81T**MMO.....	C15-C17, C68-C70
81T***HWA	C15, C17, C69-C71
81T*** Solar.....	C16, C17, C68
81T201-WMSHWA to	
81T231-WMSHWA.....	C17, C71
1600T6 Series.....	C18, C72-C73
DEFM-100.....	C15
1600T9.....	C19, C74
DEMD-86505 to	
DEMD-86515.....	C19

CONCEALED FLUSH VALVES (UR)

1600T6 Series.....	C18, C72-C73
1600T9.....	C19, C74

LAVATORY

SINGLE HANDLE

22C.....	C21, C79-C80
24T2.....	C84
501LF-HDF to	
523LF-HDF	C20
570LF-06ELH.....	C31
710LF-HDF.....	C31

TWO HANDLE

21C.....	C22-C23, C76-C78
23C.....	C24, C81-C83
2529LF-HDF	
to 2529LF-HDM	C22
3549LF-WFLGHDF.....	C23
3579LF-WFLGHDF.....	C24

SINK FAUCETS

SINGLE HANDLE DECK MOUNT KITCHEN

100LF-HDF,	
101LF-HDF &	
400LF-HDF	C25
27C6.....	C102

TWO HANDLE DECK MOUNT BAR

25C3.....	C28, C85
27C4.....	C28, C97-C101
2171LF-WBHDF.....	C28

TWO HANDLE WALL MOUNT

28C2.....	C29, C103
28C4.....	C30, C105-C106
28C6.....	C107-C108
28C8.....	C109
28C9LH.....	C110
28P Series.....	C30
28T9.....	C29, C110
28T910 & 28T911.....	C104, C109-C110

METERING

86T & 87T.....	C32, C112-C113
701LF-HDF.....	C32
2507LF-HDF.....	C32

LABORATORY

W62.....	C116
W6629 & W6635.....	C117
W66 Series.....	C118
W67 Series.....	C119-C120

SURGEON SCRUB UP

54T5.....	C122
-----------	------

PRE-RINSE FAUCETS

55C Series.....	C33, C124
-----------------	-----------

DRAINAGE

33T2 Series.....	C34, C126
33T3.....	C34, C126

TUB/SHOWER

ROUGH-INS

R10000.....	C35, C132, C134
R10700-UNWS.....	C35, C132, C134

TRIM – PRESSURE BALANCE

T13090 to T13491.....	C36-C37
T13391 to T13691.....	C37
T13H1 & T13H2.....	C38-C39, C128-C130
T13H3.....	C39, C131-C132

TRIM – THERMOSTATIC

T17TH1.....	C40, C133-C134
-------------	----------------

ARCHITECTURAL™ DESIGN SERIES

BATHROOM FAUCETS

810DPA Electronic Faucets	C136
820DPA Electronic Faucets	C137
830DPA Electronic Faucets	C138

PARTS & ACCESSORIES

RPW124HDF to	
RPW336HDF	C41

MIXING VALVES

R2570-MIXLF,	
R2910-MIXLF &	
R3070-MIXLF	C42, C140

COMPONENTS

Spout Outlets and Inserts	C142
Spouts.....	C143-C144
Repair Parts.....	C145-C149

Model Number	Case Qty.	Page Number	List Price	Universal Product Code	Model Number	Case Qty.	Page Number	List Price	Universal Product Code
21C122	6	C22	217.10	55870252066	26C3943	3	C26	298.25	55870267206
21C132	6	C22	205.65	55870252707	26C3944	1	C26	339.70	55870255777
21C133	6	C22	204.00	55870267039	27C2924	1	C27	351.60	55870254398
21C133-TI	6	C23	217.50	55870317017	27C2932	1	C27	316.20	55870254565
21C134	6	C23	240.25	55870252721	27C2933	3	C27	314.45	55870267213
21C142	6	C22	201.15	55870251274	27C2942	3	C27	311.55	55870254572
21C143	6	C22	199.50	55870267046	27C2944	3	C27	334.85	55870254435
21C144	6	C23	235.50	55870252745	27C2974	1	C27	351.60	55870254459
21C233	1	C23	271.10	55870267060	27C4822	1	C28	271.95	55870255159
22C101	6	C21	209.35	55870267077	27C4832	3	C28	259.80	55870251281
22C301	6	C21	247.70	55870267084	27C4842	3	C28	255.10	55870255166
22C401	6	C21	234.80	55870268371	27C4924	1	C28	295.25	55870254947
22C601	6	C21	231.65	55870267091	27C4934	1	C28	283.10	55870254961
22C801	6	C21	259.90	55870267107	27C4943	3	C28	253.40	55870267237
23C332	1	C24	326.20	55870253735	27C4944	3	C28	278.45	55870254985
23C333	3	C24	324.65	55870267114	28C2383	1	C29	472.50	55870267244
23C334	1	C24	367.55	55870253391	28C4433	6	C30	338.55	55870267268
23C342	1	C24	339.55	55870253742	28P4202LF	3	C30	257.60	55870373587
23C624	1	C24	356.05	55870253537	28P4402LF	3	C30	257.60	55870373600
23C632	1	C24	303.80	55870253810	28P4902LF	3	C30	257.60	55870373624
23C634	1	C24	325.90	55870253551	28T9	4	C29	214.60	778062593609
23C642	1	C24	299.30	55870253827	33T260	1	C34	26.90	778062401058
23C643	3	C24	297.75	55870267121	33T290	20	C34	50.50	778062407807
23C644	3	C24	339.15	55870253575	33T301	12	C34	58.55	778062409900
25C3837	1	C28	316.35	55870267138	33T311	12	C34	60.05	778062412054
25C3847	1	C28	311.65	55870267145	33T360	12	C34	74.25	778062421254
25C3877	1	C28	328.45	55870267152	55C1513	1	C33	826.15	55870340978
26C3124	1	C26	331.95	55870255616	81T201-48-WMSHWA	1	C17	890.15	55870420021
26C3132	1	C26	298.35	55870255814	81T201BTA	3	C15	687.55	55870348141
26C3133	1	C26	296.75	55870267176	81T201BTA-DF	3	C15	687.55	55870361539
26C3134	1	C26	320.55	55870255630	81T201BTA-MMO	3	C15	687.55	55870431904
26C3142	1	C26	294.00	55870255821	81T201BTA-MMO-BL	3	C15	796.20	55870458383
26C3143	1	C26	292.25	55870267183	81T201HWA	3	C15	747.25	55870349353
26C3144	1	C26	333.45	55870255654	81T201SP-42-MMO	1	C16	831.15	55870453210
26C3924	1	C26	356.55	55870255739	81T201SP-48-MMO	1	C16	831.15	55870453227
26C3933	4	C26	302.70	55870267190	81T201SP-DF-MMO	1	C16	831.15	55870453234
26C3934	1	C26	344.45	55870255753	81T201SP-MMO	1	C16	831.15	55870453241

Quick Pick Product Numerical Price List

Model Number	Case Qty.	Page Number	List Price	Universal Product Code	Model Number	Case Qty.	Page Number	List Price	Universal Product Code
81T201-WMSHWA	1	C17	930.25	55870419995	590-TFLGHGMHDF	6	C7	555.15	55870477162
81T231BTA	3	C16	687.55	55870349438	590-TFHGMHDF	6	C7	584.65	55870477155
81T231BTA-19	3	C16	687.55	55870361607	590TPA0120	3	C3	665.85	55870464377
81T231BTA-MMO	3	C16	687.55	55870431928	590TPA0128TR	3	C3	344.75	55870464384
81T231BTA-MMO-BL	3	C16	796.20	55870459021	590TPA0158TR	3	C3	344.75	55870464407
81T231HWA	3	C17	747.25	55870349469	590TPA1120	3	C3	708.85	55870464438
81T231SP-05-MMO	1	C17	831.15	55870453258	590TPA1190	3	C3	708.85	55870464452
81T231SP-19-MMO	1	C17	831.15	55870453265	590TPA2120-PI	3	C3	708.85	55870470217
81T231SP-MMO	1	C17	831.15	55870453272	591TF0250	6	C8	684.05	55870252790
81T231-WMSHWA	1	C17	930.25	55870420069	591TF1250	6	C8	684.05	55870251298
86T505	1	C19	202.70	778062341507	591-TFLGHGMHDF	6	C7	582.00	55870477186
86T1153	6	C32	326.40	55870137578	591-TFHGMHDF	6	C7	611.45	55870477179
87T104	6	C32	183.95	55870282858	591TPA0250	6	C3	665.85	55870464520
87T105	6	C32	196.80	55870282872	591TPA0290	6	C3	665.85	55870464544
87T110	6	C32	225.80	55870282889	591TPA1250	6	C3	708.85	55870464575
87T111	6	C32	239.35	55870282902	591TPA2220-PI	6	C3	708.85	55870470231
87T151	12	C32	55.85	55870282919	620TPA3320	3	C2	665.85	55870464667
100LF-HDF	6	C25	185.95	34449643870	620TPA3320-BL	3	C2	745.20	55870464674
101LF-HDF	6	C25	187.65	34449643887	620TPA3320-SS	3	C2	745.20	55870464681
400LF-HDF	6	C25	226.50	34449643894	620TPA3358TR	3	C2	344.70	55870464735
501LF-HDF	6	C20	183.35	34449643917	621TPA3350	3	C2	708.85	55870464797
501LF-HGMHDF	6	C20	186.40	34449643948	621TPA3350-BL	3	C2	788.60	55870464803
501LF-TGMHDF	6	C20	186.40	34449685405	621TPA3350-SS	3	C2	788.60	55870464810
511LF-HDF	6	C20	197.95	34449643993	701LF-HDF	6	C32	174.85	34449702928
511LF-HGMHDF	6	C20	200.85	34449643955	710LF-HDF	6	C31	307.60	34449644013
515LF-HDF	6	C20	229.60	34449643979	860T167	1	C40	1,563.10	55870323407
516LF-HDF	6	C20	223.35	34449643986	860T178	1	C40	1,563.10	55870407909
516LF-HGMHDF	6	C20	226.40	34449643900	1500TF3320	1	C9	783.00	55870299979
520LF-HDF	6	C20	215.45	34449643924	1500TF4670	1	C59	854.95	55870325937
520LF-HGMHDF	6	C20	218.75	34449644006	1501TF3320	1	C9	783.00	55870295063
520LF-TGMHDF	6	C20	218.75	34449685412	1501TF4670	1	C59	848.25	55870325968
523LF-HDF	6	C20	209.70	34449643931	1600T6102ARI-42	1	C18	594.15	55870459571
523LF-HGMHDF	6	C20	212.95	34449643962	1600T6102ATR-42	1	C18	594.15	55870459588
523LF-TGMHDF	6	C20	212.95	34449685429	1600T6103ARI	1	C18	586.90	55870418660
570LF-06ELH	6	C31	214.30	34449694803	1600T6103ATR	1	C18	586.90	55870418691
590TF0120	3	C8	684.05	55870314498	1600T9001RI	1	C19	463.75	55870295919
590TF1120	3	C8	684.05	55870314672	1600T9001TR	3	C19	463.75	55870295957



• Full case quantity restriction on this model - priced each.
Please always order in full case.

DELTA COMMERCIAL TECHNICAL SERVICE 1-877-509-2680
ONLINE CATALOG: deltafaucet.com (Complete Product Offering & Part Numbering System)

Model Number	Case Qty.	Page Number	List Price	Universal Product Code	Model Number	Case Qty.	Page Number	List Price	Universal Product Code
2171LF-WBHDF.....	6	C28	235.65	34449648332	DEMD-201LF.....	1	C59	800.65	55870393608
2507LF-HDF.....	6	C32	305.15	34449708401	DEMD-211LF.....	1	C5	847.35	55870393615
2529LF-HDF.....	6	C22	255.15	34449662413	DEMD-212LF.....	1	C5	847.35	55870411999
2529LF-HDM.....	6	C22	272.10	34449662444	DEMD-301LF.....	6	C5	739.5	55870393622
2529LF-LGHDF.....	6	C22	216.80	34449662420	DEMD-311LF.....	6	C5	787.40	55870393639
2529LF-LGHGMHDF.....	6	C22	220.15	34449662437	DEMD-312LF.....	1	C5	787.40	55870412002
3549LF-WFLGHDF.....	6	C23	361.10	34449702959	DEMD-320LF.....	1	C4	754.65	55870437340
3579LF-WFLGHDF.....	6	C24	376.30	34449702973	DEMD-321LF.....	1	C4	848.30	55870437357
060546A.....	1	C47	85.35	55870260177	DEMD-402LF.....	6	C6	927.35	55870393646
060547A.....	1	C47	109.65	55870259928	DEMD-404LF.....	1	C6	886.60	55870393653
060683A.....	1	C12	59.30	55870312005	DEMD-611-10LF.....	4	C4	959.85	55870432222
060917A.....	4	C13	46.05	55870313026	DEMD-611LF.....	4	C4	959.85	55870411616
060918A.....	1	C13	98.05	55870313033	DEMD-86505.....	6	C19	565.70	55870372658
060919A.....	1	C13	77.45	55870313002	DEMD-86515.....	6	C19	597.85	55870372665
060958A.....	1	C6	55.85	55870331488	DESD-750.....	6	C13	590.45	55870454354
060967A.....	1	C6	300.40	55870324831	DESD-751.....	6	C13	590.45	55870454361
060974A.....	1	C6	79.65	55870326446	DESD-751-BL.....	6	C13	735.10	55870468757
061047A.....	1	C12	71.25	55870342736	ELAVT0001ARI.....	1	C8	542.80	55870414280
061159A.....	1	C14	85.35	55870380417	ELAVT0008ARI.....	1	C8	806.90	55870414297
061160A.....	1	C14	109.60	55870380424	R2570-MIXLF.....	1	C42	212.35	55870392342
061269A.....	1	C14	85.90	55870411807	R2910-MIXLF.....	24	C42	82.95	34449721783
061269BL.....	1	C14	104.00	55870443259	R3070-MIXLF.....	1	C42	172.10	55870381124
061269SS.....	1	C14	104.00	55870411814	R3270-MIXLF.....	20	C42	172.10	55870471672
061305A.....	1	C14	102.55	55870429277	R10000-UNWS.....	12	C134	100.35	34449518031
061305SS.....	1	C14	113.00	55870429284	R10700-UNWS.....	6	C134	141.30	55870289093
061398A.....	1	C7	212.76	55870477568	RP30528.....	1	C14	117.20	34449417365
061399A.....	1	C8	30.00	55870477575	RP32508.....	1	C12	60.75	34449434539
063266A.....	1	C11	52.50	55870460027	RP32856.....	1	C12	60.75	34449441872
063268A.....	1	C11	71.25	55870460041	RP34280.....	1	C14	165.75	34449447508
063269A.....	1	C11	71.25	55870460058	RPW124HDF.....	1	C41	229.85	34449434058
063270A.....	1	C11	59.30	55870460065	RPW136HDF.....	1	C41	253.35	34449434072
063271A.....	1	C11	45.0	55870460072	RPW324HDF.....	1	C41	299.0	34449434096
063276A.....	1	C11	316.90	55870460126	RPW324HDF-1.5.....	1	C41	293.10	55870338241
DEFM-100.....	12	C15	392.0	55870321069	RPW324HDF-LHD.....	1	C41	282.5	34449770804
DEMD-101LF.....	1	C4	747.35	55870393585	RPW336HDF.....	1	C41	322.60	34449434119
DEMD-111LF.....	1	C4	794.0	55870393592	T13H132.....	6	C38	136.5	55870345225
DEMD-112LF.....	1	C4	794.0	55870411982	T13H152.....	1	C38	355.50	55870345232

• Full case quantity restriction on this model - priced each.
Please always order in full case.

DELTA COMMERCIAL TECHNICAL SERVICE 1-877-509-2680
ONLINE CATALOG: deltafaucet.com (Complete Product Offering & Part Numbering System)

Quick Pick Product Numerical Price List

Model Number	Case Qty.	Page Number	List Price	Universal Product Code
T13H153	1	C39	336.95	55870285804
T13H163	6	C38	302.25	55870285811
T13H232	6	C38	161.80	55870345294
T13H253	1	C39	381.30	55870285828
T13H333	1	C39	560.35	55870285842
T17TH125	6	C40	500.10	55870346307
T17TH155	1	C40	669.65	55870346284
T13090	12	C36	102.55	34449533515
T13091	12	C36	102.55	34449533553

Model Number	Case Qty.	Page Number	List Price	Universal Product Code
T13290	12	C36	123.70	34449533522
T13291	12	C37	123.70	34449533560
T13291-LHD	12	C37	106.70	34449583947
T13391	12	C37	102.55	55870327665
T13490	12	C36	154.30	34449533539
T13491	12	C37	154.30	34449533577
T13491-LHD	12	C37	138.10	34449572804
T13691	12	C37	154.30	55870327689



Delta® Commercial offers a comprehensive line of commercial-grade faucets and accessories for healthcare facilities, education facilities, public facilities and offices. Please contact your Delta® Commercial representative for more details.

**Please always order in full case. Delta Commercial Technical Service 1-877-509-2680.
deltafaucet.com (Complete Product Offering & Part Numbering System)**



Proximity® Deckmount Bathroom Faucet



Model	Flow	Price	Finish
620TPA3320	1.5 gpm	665.85	Chrome
621TPA3350	0.5 gpm	708.85	Chrome
620TPA3320-BL	1.5 gpm	745.20	Matte Black
621TPA3350-BL	0.5 gpm	788.60	Matte Black
620TPA3320-SS	1.5 gpm	745.20	Brilliance® Stainless
621TPA3350-SS	0.5 gpm	788.60	Brilliance® Stainless

621TPA3350 models are not WaterSense® Labeled

- 1-hole installation
- 4 4/5" long, 9 5/8" high
- Gooseneck spout
- Hands-free activation
- Entire spout is sensor
- Adjustable sensing range, auto shut-off, metering mode, and periodic rinse feature
- Surface mounted control box
- Mixing valve required
- 2 1/2" max. deck thickness
- Vandal resistant laminar outlet
- Order 061269A for 4" optional cover plate
- Hardwire, order AC filter (063271A) and transformer separately
- Hardwire with battery back-up order 063269A for recessed mount box; transformer required



Proximity® Deckmount Bathroom Faucet Trim



Model	Flow	Price	Finish
620TPA3358TR	0.5 gpm	344.70	Chrome

- 1-hole installation
- 4 4/5" long, 9 5/8" high
- Gooseneck spout
- Trim only
- Requires separate order of ELAVT0008ARI for complete product
- Hands-free activation
- Entire spout is sensor
- Adjustable sensing range, auto shut-off, metering mode and periodic rinse feature
- 2 1/2" max. deck thickness
- Vandal resistant laminar outlet
- Order 061269A for 4" optional cover plate
- Hardwire, order AC filter (063271A) and transformer separately
- Hardwire with battery back-up order 063269A for recessed mount box; transformer required



Proximity® Deckmount Bathroom Faucet



Model	Flow	Price	Finish
590TPA0120	1.5 gpm	665.85	Chrome
590TPA1120	1.5 gpm	708.85	Chrome
590TPA1190	0.35 gpm	708.85	Chrome
590TPA2120-PI	1.5 gpm	708.85	Chrome

590TPA190 is not WaterSense® Labeled

- 1-hole installation
- 5" long, 7 1/2" high
- Cast hi-rise spout
- Hands-free activation
- Entire spout is sensor
- Adjustable sensing range, auto shut-off, metering mode and periodic rinse feature
- Surface mounted control box
- Recessed control box options available
- Mixing valve required
- 3" max. deck thickness
- Vandal resistant Agion® antimicrobial laminar outlet
- Order 061159A for 4" or 061160A for 8" optional cover plate
- 590TPA0120 - Hardwire, order AC filter (063271A) and transformer separately
- 590TPA1120 - Battery operated, batteries included
- 590TPA1190 - Battery operated, batteries included
- 590TPA2120-PI - Plug-in, power supply included
- Hardwire with battery back-up order 063268A for surface mount box; transformer required



Proximity® Deckmount Bathroom Faucet Trim



Model	Flow	Price	Finish
590TPA0128TR	1.5 gpm	344.75	Chrome
590TPA0158TR	0.5 gpm	344.75	Chrome

590TPA0158TR is not WaterSense® Labeled

- 1-hole installation
- 5" long, 7 1/2" high
- Cast hi-rise spout
- Trim only
- Requires separate order of ELAVT0008ARI for complete product
- Hands-free activation
- Entire spout is sensor
- Adjustable sensing range, auto shut-off, metering mode and periodic rinse feature
- Surface mount control box options available
- 3" max. deck thickness
- 590TPA0128TR - Vandal resistant Agion® antimicrobial laminar outlet
- 590TPA0158TR - Vandal resistant laminar outlet
- Order 061159A for 4" or 061160A for 8" optional cover plate
- Hardwire, order AC filter (063271A) and transformer separately
- Hardwire with battery back-up order 063268A for surface mount box; transformer required



Proximity® Deckmount Bathroom Faucet



Model	Flow	Price	Finish
591TPA0250	0.5 gpm	665.85	Chrome
591TPA0290	0.35 gpm	665.85	Chrome
591TPA1250	0.5 gpm	708.85	Chrome
591TPA2220-PI	1.5 gpm	708.85	Chrome

- 3-hole 4" installation
- 5" long, 5 4/5" high
- Cast body
- Hands-free activation
- Entire spout is sensor
- Adjustable sensing range, auto shut-off, metering mode and periodic rinse feature
- Surface mounted control box
- Recessed mount control box options available
- 2 1/2" max. deck thickness
- Mixing valve required
- Vandal resistant laminar outlet
- 591TPA0250 - Hardwire, order AC filter (063271A) and transformer separately
- 591TPA1250 - Battery operated, batteries included
- 591TPA0290 - Hardwire, order AC filter (063271A) and transformer separately
- 591TPA2220-PI - Plug-in, power supply included
- Hardwire with battery back-up order 063268A for surface mount box, transformer required



Electronic Solar Bathroom Faucet



Model	Flow	Price	Finish
DEMD-320LF	0.5 gpm	754.65	Chrome

- 1-hole installation
- 4 7/8" long, 7 5/8" high
- For cold or premixed water
- Vandal resistant hidden spray outlet
- 2 1/2" max. deck thickness
- Solar powered, user activated infrared sensor with battery assist - 4 (AA) batteries required and included



Electronic Solar Bathroom Faucet



Model	Flow	Price	Finish
DEMD-321LF	0.5 gpm	848.30	Chrome

- 1-hole installation
- 4 7/8" long, 7 5/8" high
- Integrated side mixer to adjust temperature.
- Vandal resistant hidden spray outlet
- Red/blue indicators
- 2 1/2" max. deck thickness
- Solar powered, user activated infrared sensor with battery assist - 4 (AA) batteries required and included



Electronic ASSE 1070 Thermostatic Bathroom Faucet



Model	Flow	Price	Finish
DEMD-611LF	.17 gpc	959.85	Chrome
DEMD-611-10LF	0.5 gpc	959.85	Chrome

ADA valve activation only
 Note: Will be discontinued Dec. 31, 2023
 Not available in California

- 1-hole installation
- 4 7/8" long, 7 5/16" high
- ASSE 1070 thermostatic electronic metering faucet with above deck electronics
- Integrated thermostatic mixing valve
- Integrated solenoid
- Mixing handle adjusts temperature
- Anti-rotation pin
- 1 4/5" max. deck thickness
- Vandal resistant wrench flat spray outlet
- Order 060585A for optional 4" cover plate
- Adjustable comfort limit stop
- Battery operated, batteries included
- DEMD-611-10LF - .25 gal/cycle @ 60 psi, .95 L/cycle @ 414 kPa based on 15 second max. run time
- DEMD-611LF - .17 gal/cycle @ 60 psi, .64 L/cycle @ 414 kPa based on 15 second max. run time



Electronic Bathroom Faucet



Model	Flow	Price	Finish
DEMD-101LF	0.5 gpm	747.35	Chrome

Note: Will be discontinued Dec. 31, 2023
 Not available in California

- 1-hole installation
- 4 1/2" long, 6 7/8" high
- Above deck solenoid and battery
- For cold or premixed water
- Vandal resistant wrench flat spray outlet
- 1 1/2" max. deck thickness
- Battery operated, batteries included



Electronic Bathroom Faucet



Model	Flow	Price	Finish
DEMD-111LF	0.5 gpm	794.00	Chrome

Note: Will be discontinued Dec. 31, 2023
 Not available in California

- 1-hole installation
- 4 1/2" long, 6 7/8" high
- Above deck solenoid and battery
- Side mixer
- Red/blue indicator
- Vandal resistant wrench flat spray outlet
- 1 1/2" max. deck thickness
- Battery operated, batteries included



Electronic Bathroom Faucet



Model	Flow	Price	Finish
DEMD-112LF	0.5 gpm	794.00	Chrome

Note: Will be discontinued Dec. 31, 2023
 Not available in California

- 1-hole installation
- 4 1/2" long, 6 7/8" high
- Above deck solenoid and battery
- Side technicians mixer
- Temperature set and adjusted with Allen key (included)
- Vandal resistant wrench flat spray outlet
- 1 1/2" max. deck thickness
- Battery operated, batteries included



Electronic Bathroom Faucet



Model	Flow	Price	Finish
DEMD-201LF	0.5 gpm	800.65	Chrome

Note: Will be discontinued Dec. 31, 2023
Not available in California

- 1-hole installation
- 6 5/16" long, 11 7/16" high
- Above deck electronics
- For cold or premixed water
- Vandal resistant wrench flat spray outlet
- 1 1/4" max. deck thickness
- Battery operated, batteries included



Electronic Bathroom Faucet



Model	Flow	Price	Finish
DEMD-211LF	0.5 gpm	847.35	Chrome

Note: Will be discontinued Dec. 31, 2023
Not available in California

- 1-hole installation
- 6 5/16" long, 11 7/16" high
- Above deck electronics
- Side mixer
- Red/blue indicator
- Vandal resistant wrench flat spray outlet
- 1 1/4" max. deck thickness
- Battery operated, batteries included



Electronic Bathroom Faucet



Model	Flow	Price	Finish
DEMD-212LF	0.5 gpm	847.35	Chrome

Note: Will be discontinued Dec. 31, 2023
Not available in California

- 1-hole installation
- 6 5/16" long, 11 7/16" high
- Above deck electronics
- Side technicians mixer
- Temperature set and adjusted with Allen key (included)
- Vandal resistant wrench flat spray outlet
- 1 1/4" max. deck thickness
- Battery operated, batteries included



Electronic Bathroom Faucet



Model	Flow	Price	Finish
DEMD-301LF	0.5 gpm	739.05	Chrome

Note: Will be discontinued Dec. 31, 2023
Not available in California

- 1-hole installation
- 4 5/16" long, 5 5/8" high
- For cold or premixed water
- Vandal resistant wrench flat spray outlet
- 2" max. deck thickness
- Battery operated, batteries included



Electronic Bathroom Faucet



Model	Flow	Price	Finish
DEMD-311LF	0.5 gpm	787.40	Chrome

Note: Will be discontinued Dec. 31, 2023
Not available in California

- 1-hole installation
- 4 5/16" long, 5 5/8" high
- Side mixer
- Red/blue indicators
- Vandal resistant wrench flat spray outlet
- 2" max. deck thickness
- Battery operated, batteries included



Electronic Bathroom Faucet



Model	Flow	Price	Finish
DEMD-312LF	0.5 gpm	787.40	Chrome

Note: Will be discontinued Dec. 31, 2023
Not available in California

- 1-hole installation
- 4 5/16" long, 5 5/8" high
- Side technicians mixer
- Temperature set and adjusted with allen key (included)
- Vandal resistant wrench flat spray outlet
- 2" max. deck thickness
- Battery operated, batteries included



Electronic Wall Mount Bathroom Faucet



Model	Flow	Price	Finish
DEMD-402LF	0.5 gpm	927.35	Chrome

- 1-hole wall mount installation
- 8" long
- For cold or premixed water
- Hardwire, order transformer separately
- Hardwire 24 VAC to 9 VDC converter supplied

Note: Will be discontinued Dec. 31, 2023
Not available in California



Electronic Wall Mount Bathroom Faucet



Model	Flow	Price	Finish
DEMD-404LF	0.5 gpm	886.60	Chrome

- 1-hole wall mount installation
- 6" long
- For cold or premixed water
- Hardwire, order transformer separately
- Hardwire 24 VAC to 9 VDC converter supplied

Note: Will be discontinued Dec. 31, 2023
Not available in California



DEMD Transformer

Model	Flow	Price	Finish
060958A	-	55.85	-

- Plug in transformer ONLY for select DEMD faucet models
- 120 VAC to 9 VDC
- No converter required
- For hardwire conversions, see specification sheets



DEMD Remote

Model	Flow	Price	Finish
060967A	-	300.40	-

- Remote control ONLY for select DEMD faucet models



DEMD Converter

Model	Flow	Price	Finish
060974A	-	79.65	-

- Hardwire converter ONLY for select DEMD faucet models
- 24 VAC to 9 VDC
- Transformer required; order separately
- For hardwire conversions, see specification sheets

NEW!



**Battery Electronic Lav Faucet,
VR 0.5 GPM, L/Grid Strainer**



Model	Flow	Price	Finish
590-TFLGHGMHDF	0.5 gpm	555.15	Chrome

- 1-hole installation
- 5" long, 3 3/4" high
- All metal faucet construction
- Hands-free activation
- H₂Optics® Sensing Technology
- Mixing valve required
- 1" max. deck thickness
- Vandal resistant laminar outlet
- Less grid strainer
- No lift rod hole
- Battery operated, batteries included
- Integrated supply hose included

NEW!



**Battery Electronic Lav Faucet,
VR 0.5 GPM, Grid Strainer**



Model	Flow	Price	Finish
590-TFHGMHDF	0.5 gpm	584.65	Chrome

- 1-hole installation
- 5" long, 3 3/4" high
- All metal faucet construction
- Hands-free activation
- H₂Optics® Sensing Technology
- Mixing valve required
- 1" max. deck thickness
- Vandal resistant laminar outlet
- Grid strainer
- No lift rod hole
- Battery operated, batteries included
- Integrated supply hose included

NEW!



**Battery Electronic Lav Faucet,
VR 0.5 GPM, L/Grid Strainer**



Model	Flow	Price	Finish
591-TFLGHGMHDF	0.5 gpm	582.00	Chrome

- 3-hole 4" installation
- 5" long, 4 3/8" high
- All metal faucet construction
- Hands-free activation
- H₂Optics® Sensing Technology
- Mixing valve required
- 1 1/2" max. deck thickness
- Vandal resistant laminar outlet
- Less grid strainer
- No lift rod hole
- 4" Anti-rotation cover plate
- Battery operated, batteries included
- Integrated supply hose included

NEW!



**Battery Electronic Lav Faucet,
VR 0.5 GPM, Grid Strainer**



Model	Flow	Price	Finish
591-TFHGMHDF	0.5 gpm	611.45	Chrome

- 3-hole 4" installation
- 5" long, 4 3/8" high
- All metal faucet construction
- Hands-free activation
- H₂Optics® Sensing Technology
- Mixing valve required
- 1 1/2" max. deck thickness
- Vandal resistant laminar outlet
- Grid strainer
- No lift rod hole
- 4" Anti-rotation cover plate
- Battery operated, batteries included
- Integrated supply hose included

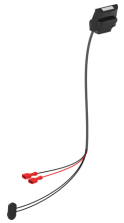

590-TFHDF Sensor-Controller Asm

Model	Flow	Price	Finish
061398A	-	212.76	-

- For use with 590-TFHDF & 591-TFHDF series

• For use with 590-TFHDF & 591-TFHDF series



Hose-Aerator Housing Asm

Model	Flow	Price	Finish
061399A	-	30.00	-



H₂Optics® Bathroom Faucet



Model	Flow	Price	Finish
590TF0120	1.5 gpm	684.05	Chrome
590TF1120	1.5 gpm	684.05	Chrome

Note: Available in Q4 2023

- 1-hole installation
- 5" long, 7" high
- Cast body
- Hands-free activation
- H₂Optics® Sensing Technology
- Adjustable sensing range, auto shut-off, metering mode and periodic rinse feature
- Surface mounted control box
- Recessed control box options available
- Mixing valve required
- 2 1/2" max. deck thickness
- Vandal resistant laminar outlet
- Order 060546A for 4" or 060547A for 8" optional cover plate
- 590TF0120 - Hardwire, order transformer separately
- 590TF1120 - Battery operated, batteries included



H₂Optics® Bathroom Faucet



Model	Flow	Price	Finish
591TF0250	0.5 gpm	684.05	Chrome
591TF1250	0.5 gpm	684.05	Chrome

Note: Available in Q4 2023

- 3-hole 4" installation
- 5" long, 5 5/16" high
- Cast body
- Hands-free activation
- H₂Optics® Sensing Technology
- Adjustable sensing range, auto shut-off, metering mode and periodic rinse feature
- Surface mounted control box
- Recessed control box options available
- Mixing valve required
- 2 1/2" max. deck thickness
- Vandal resistant laminar outlet
- 591TF0250 - Hardwire, order transformer separately
- 591TF1250 - Battery operated, batteries included



H₂Optics® Deck Mount Faucet



Model	Flow	Price	Finish
1500TF3320	1.5 gpm	783.00	Chrome
1501TF3320	1.5 gpm	783.00	Chrome

Note: Available in Q4 2023

- 1-hole installation
- 6" long, 14 3/4" high
- Cast brass body
- Hands-free activation
- H₂Optics® Sensing Technology
- Adjustable sensing range, auto shut-off, metering mode and periodic rinse feature
- Surface mount box
- Mixing valve required
- 2 1/2" max. deck thickness
- Vandal resistant Agion® antimicrobial laminar outlet
- Order 060546A for 4" or 060547A for 8" optional cover plate
- 1500TF3320 - Hardwire, order required transformer separately (060704A)
- 1501TF3320 - Battery operated, batteries included



H₂Optics® Wall Mount Faucet



Model	Flow	Price	Finish
1500TF4618TR	1.5 gpm	630.39	Chrome
1500TF4628TR	1.5 gpm	630.39	Chrome
1500TF4678TR	1.5 gpm	630.39	Chrome

Note: Available in Q4 2023

- Wall mount installation
- 6" long, 15 1/2" high
- Cast brass body
- Hands-free activation
- H₂Optics® Sensing Technology
- Adjustable sensing range, auto shut-off, metering mode and periodic rinse feature
- Surface mount box
- Mixing valve required
- Smooth end spout with laminar flow control in base
- Hardwire, order required transformer separately (060704A)
- Trim, order Rough-In separately (ELAVT0001ARI or ELAVT0008ARI)

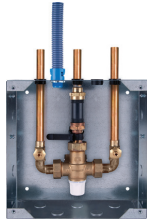

Deckmount Bathroom Rough-in Valve

Model	Flow	Price	Finish
ELAVT0008ARI	-	806.90	-

- Rough-in only
- Below deck
- Recessed mount 10" x 10" box with thermostatic mixing valve
- Order trim separately

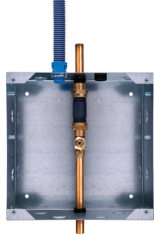

Deckmount Bathroom Rough-in Valve

Model	Flow	Price	Finish
ELAVT0001ARI	-	542.80	-

- Rough-in only
- Below deck
- Recessed mount 10" x 10" box with single inlet supply
- Order trim separately



Plug-in Power Supply

Model	Flow	Price	Finish
063266A	-	52.50	-

- Plug-in power supply for Proximity® faucets
- Supplies power for up to 5 faucets
- Use with Proximity® faucet series 590-PAHDF, 590TPA, 591TPA, 620TPA, 630TPA



Hardwire AC Filter

Model	Flow	Price	Finish
063271A	-	45.00	-

- Hardwire filter for Proximity® installations
- AC filter 24V AC to 18V DC
- Use with Proximity® faucet series 590-PAHDF, 590TPA, 591TPA, 620TPA, 630TPA



Battery Back-up Assembly - Surface Box

Model	Flow	Price	Finish
063268A	-	71.25	-

- Battery backup for surface mount box #0 to convert installed hardwire or plug-in models
- One battery backup unit required for every spout/box
- Use with Proximity® faucet series 590-PAHDF, 590TPA, 591TPA, 620TPA, 630TPA
- Batteries included



Battery Back-up Assembly - Recessed Box

Model	Flow	Price	Finish
063269A	-	71.25	-

- Battery backup for recessed mount boxes #1 and #8 to convert installed hardwire models
- One battery backup unit required for every spout/box
- Use with Proximity® faucet series 590TPA, 591TPA, 620TPA, 630TPA
- Batteries included



Hardwire Converter

Model	Flow	Price	Finish
063270A	-	59.30	-

- Converts 24 VAC to 6.4 VDC
- Use with Proximity® faucet series 590-PAHDF, 590TPA, 591TPA, 620TPA, 630TPA



Proximity® Retrofit Kit

Model	Flow	Price	Finish
063276A	-	316.90	-

- Proximity® upgrade/conversion kit for hardwire recessed box
- Use with Proximity® faucet series 590-PAHDF, 590TPA, 591TPA, 620TPA, 630TPA

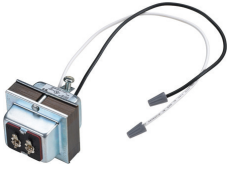

Optional Hardwire Transformer

Model	Flow	Price	Finish
RP32508	-	60.75	-

- Hardwire transformer
- Supplies power for up to 10 Delta® 590-HDF electronic faucets converted to hardwire or for 10 - 860T faucets or up to 5 - 3000T, 1500T, 590T, 590-PAHDF, 590TP / 590TPA, 591T, 591TP / 591TPA, 600T, 620TP / 620TPA, 630TP / 630TPA, DEMD, 1600T, 81THWA and 81TWMS series



Plug-in Transformer

Model	Flow	Price	Finish
RP32856	-	60.75	-

- Plug-in transformer
- Supplies power for up to 10 Delta® 590-HDF electronic faucets converted to hardwire or for 10 - 860T faucets or up to 5 - 3000T, 1500T, 590T, 590TP, 591T, 591TP, 600T, 620TP, 630TP, DEMD, 1600T, 81THWA and 81TWMS series faucets



Hardwire Converter with Battery Back-Up

Model	Flow	Price	Finish
061047A	-	71.25	-

- Hardwire converter with battery back-up
- Use with series 590T, 590TP, 590-PHDF, 590-HDF, 591T, 591TP, 600T, 620TP, 630TP, 860T, 1500T, 1600T, 3000T, 81THWA and 81TWMS series faucets



Hardwire Converter

Model	Flow	Price	Finish
060683A	-	59.30	-

- Hardwire converter
- Converts 24 VAC to 6.4 VDC for 590-HDF, 3000T, 1500T, 590T, 590TP, 591T, 591TP, 600T, 620TP, 630TP, 1600T, 81THWA and 81TWMS
- Converts 24 VAC to 6.4 VDC



Electronic Soap Dispenser



Model	Flow	Price	Finish
DESD-750	-	590.45	Chrome
DESD-751	-	590.45	Chrome
DESD-751-BL	-	735.10	Black

- 1-hole installation
- 4 1/8" long, 4 1/8" high
- Deck mount electronic hand soap dispenser
- Cast brass spout
- 33.8 oz (1,000 ml) refillable bottle included, soap not included
- To be used with standard liquid soaps with a viscosity up to 3,000 cPs
- DESD-750 - plug-in operation
- DESD-751 - battery operated, batteries included
- Overall size 20 1/8" x 2 1/8" x 3 1/2"
- 061310A - Plug-in power supply to convert battery operated to plug-in
- 2" max. deck thickness
- 3 year warranty



4" Center Cover Plate

Model	Flow	Price	Finish
061269A	-	85.90	Chrome
061269BL	-	104.00	Matte Black
061269CZ	-	104.53	Champagne Bronze®
061269SS	-	104.00	Brilliance® Stainless

- 4" center cover plate
- Anti-rotation pin
- For use with 810DPA, 820DPA and 830DPA series



4" Center Cover Plate

Model	Flow	Price	Finish
061305A	-	102.55	Chrome
061305SBL	-	101.60	Matte Black
061305SCZ	-	113.58	Champagne Bronze®
061305SS	-	113.00	Brilliance® Stainless

- 4" centerset cover plate
- Anti-rotation pin
- For use with 810DPA, 820DPA and 830DPA series



4" Center Cover Plate

Model	Flow	Price	Finish
RP30528	-	117.20	Chrome

- 4" center cover plate with locking pin
- Anti-rotation (2 1/2" x 7")
- For use with 590-HDF series



8" Center Cover Plate

Model	Flow	Price	Finish
RP34280	-	165.75	Chrome

- 8" center cover plate with locking pin
- Anti-rotation (2 1/2" x 11")
- For use with 590-HDF series



4" Center Cover Plate

Model	Flow	Price	Finish
060546A	-	85.35	Chrome

- 4" center cover plate
- Anti-rotation pin
- For use with 590T and 1500T series



8" Center Cover Plate

Model	Flow	Price	Finish
060547A	-	109.65	Chrome

- 8" center cover plate
- Anti-rotation pin
- For use with 590T and 1500T series



4" Center Cover Plate

Model	Flow	Price	Finish
061159A	-	85.35	Chrome

- 4" center cover plate
- Anti-rotation pin
- For use with 590TP / 590TPA and 590P-HDF / 590PA-HDF series



8" Center Cover Plate

Model	Flow	Price	Finish
061160A	-	109.60	Chrome

- 8" center cover plate
- Anti-rotation pin
- For use with 590TP / 590TPA and 590P-HDF / 590PA-HDF series



Electronic Side Mount Flush Kit



Model	Flow	Price	Finish
DEFM-100	-	392.00	Chrome

- Electronic side mount flush kit for converting manual 81T Teck® flush valves and 86T metering urinals to electronic operation
- For Sloan®, Crane® and some Zurn® Models
- 3 year warranty
- Battery operated, batteries included



H₂Optics® Exposed Flush Valve



Model	Flow	Price	Finish
81T201BTA-MMO	1.6 gpf	687.55	Chrome
81T201BTA-MMO-BL	1.6 gpf	796.20	Matte Black
81T201BTA-30-05-MMO	1.6 gpf	928.30	Chrome
81T201BTA-30-48- MMO	1.6 gpf	913.68	Chrome

- Electronic exposed flush valve
- Hands-free operation
- Push-button mechanical override
- H₂Optics® Sensing Technology
- For 1 1/2" top inlet water closet fixture
- Body mounted sensor
- Battery operated, batteries included
- Factory set flow rate, field adjustable
- BL – Matte Black/Chrome finish
- 81T201BTA-30-05-MMO and 81T201BTA-30-MMO-48 - Sloan®/ Zurn® retrofit models



H₂Optics® Exposed Flush Valve



Model	Flow	Price	Finish
81T201BTA	1.6 gpf	687.55	Chrome

- Electronic exposed flush valve
- Hands-free operation
- H₂Optics® Sensing Technology
- For 1 1/2" top inlet water closet fixture
- Body mounted sensor
- Battery operated, batteries included
- 81T201BTA - Factory set flow rate, field adjustable



H₂Optics® Exposed Flush Valve



Model	Flow	Price	Finish
81T201BTA-DF	1.6 gpf	687.55	Chrome

- Electronic exposed flush valve
- Hands-free operation
- H₂Optics® Sensing Technology
- For 1 1/2" top inlet water closet fixture
- Body mounted sensor
- DF models have dual flush settings factory set to ON to provide a 30% water reduced flush based on time and distance
- Battery operated, batteries included
- Factory set flow rate, field adjustable



H₂Optics® Exposed Flush Valve



Model	Flow	Price	Finish
81T201HWA	1.6 gpf	747.25	Chrome
81T201HWA-30-MMO	1.6 gpf	996.94	Chrome

- Electronic exposed flush valve
- Hands-free operation
- H₂Optics® Sensing Technology
- For 1 1/2" top inlet water closet fixture
- Body mounted sensor
- Hardwire, order transformer separately
- Hardwire with battery back-up order 061047A; transformer required
- 81T201HWA - Factory set flush, field adjustable
- 81T201HWA-6 - Factory set flow rate, NOT field adjustable
- 81T201HWA-30-MMO - Sloan®/ Zurn® retrofit models



H₂Optics® Exposed Flush Valve



Model	Flow	Price	Finish
81T231BTA-MMO	0.5 gpf	687.55	Chrome
81T231BTA-30-05-MMO	0.5 gpf	928.30	Chrome
81T231BTA-MMO-BL	0.5 gpf	796.20	Matte Black

- Electronic exposed flush valve
- Hands-free operation
- Push-button mechanical override
- H₂Optics® Sensing Technology
- For 3/4" top inlet urinal fixture
- Body mounted sensor
- Battery operated, batteries included
- Factory set flow rate, field adjustable



H₂Optics® Exposed Flush Valve



Model	Flow	Price	Finish
81T231BTA	0.5 gpf	687.55	Chrome

- Electronic exposed flush valve
- Hands-free operation
- H₂Optics® Sensing Technology
- For 3/4" top inlet urinal fixture
- Body mounted sensor
- Battery operated, batteries included
- Factory set flow rate, field adjustable



H₂Optics® Exposed Flush Valve



Model	Flow	Price	Finish
81T231BTA-19	0.5 gpf	687.55	Chrome

- Electronic exposed flush valve
- Hands-free operation
- H₂Optics® Sensing Technology
- For 3/4" top inlet urinal fixture
- Body mounted sensor
- Battery operated, batteries included
- Factory set flush, NOT field adjustable



Solar Exposed Flush Valve



Model	Flow	Price	Finish
81T201SP-MMO	1.6 gpf	831.15	Chrome
81T201SP-42-MMO	1.1 gpf	831.15	Chrome
81T201SP-48-MMO	1.27 gpf	831.15	Chrome
81T201SP-DF-MMO	1.6 gpf	831.15	Chrome

81T201SP-MMO and 81T201SP-DF-MMO are not WaterSense® Labeled

- Electronic exposed solar flush valve
- Hands-free operation
- Push-button mechanical override
- Solar powered with 4 (AA) batteries required and included
- For 1 1/2" top inlet water closet fixture
- Body mounted sensor
- Optional 24 hour automatic flush, factory set to OFF
- 81T201SP-MMO - Factory set flow rate, field adjustable
- 81T201SP-42-MMO - Factory set flow rate, NOT field adjustable
- 81T201SP-48-MMO - Factory set flow rate, NOT field adjustable
- 81T201SP-DF-MMO - Dual flush set to ON: full flush or 30% reduced flush; factory set flow rate, field adjustable
- Field adjustable models - EZ Adjust™ screw allows flush to be adjusted without shutting off water supply



H₂Optics® Exposed Flush Valve



Model	Flow	Price	Finish
81T231HWA	0.5 gpf	747.25	Chrome

- Electronic exposed flush valve
- Hands-free operation
- H₂Optics® Sensing Technology
- For 3/4" top inlet urinal fixture
- Body mounted sensor
- Hardwire, order transformer separately
- Hardwire with battery back-up, order 061047A; transformer required
- Factory set flow rate, field adjustable



H₂Optics® Exposed Flush Valve



Model	Flow	Price	Finish
81T201-48-WMSHWA	1.27 gpf	890.15	Chrome
81T201-WMSHWA	1.6 gpf	930.25	Chrome

81T201-WMSHWA is not WaterSense® Labeled

- Electronic exposed flush valve
- Hands-free operation
- H₂Optics® Sensing Technology
- For 1 1/2" top inlet water closet fixture
- Wall mount sensor
- Hardwire, order transformer separately
- Hardwire with battery back-up, order 061047A; transformer required
- 81T201-48-WMSHWA - Factory set flow rate, NOT field adjustable
- 81T201-WMSHWA - Factory set flow rate, field adjustable



H₂Optics® Exposed Flush Valve



Model	Flow	Price	Finish
81T231-WMSHWA	0.5 gpf	930.25	Chrome

- Electronic exposed flush valve
- Hands-free operation
- H₂Optics® Sensing Technology
- For 3/4" top inlet urinal fixture
- Wall mount sensor
- Hardwire, order transformer separately
- Hardwire with battery back-up, order 061047A; transformer required
- Factory set flow rate, field adjustable



Solar Exposed Flush Valve



Model	Flow	Price	Finish
81T231SP-MMO	0.5 gpf	831.15	Chrome
81T231SP-05-MMO	0.125 gpf	831.15	Chrome
81T231SP-19-MMO	0.5 gpf	831.15	Chrome

81T231SP-MMO is not WaterSense® Labeled

- Electronic exposed solar flush valve
- Hands-free operation
- Push-button mechanical override
- Solar powered with 4 (AA) batteries required and included
- For 3/4" top inlet urinal fixture
- Body mounted sensor
- Optional 24 hour automatic flush, factory set to OFF
- 81T231SP-MMO - Factory set flow rate, field adjustable
- 81T231SP-05-MMO - Factory set flow rate, NOT field adjustable
- 81T231SP-19-MMO - Factory set flow rate, NOT field adjustable
- Field adjustable models - EZ Adjust™ screw allows flush to be adjusted without shutting off water supply



H₂Optics® Concealed Flush Valve Rough



Model	Flow	Price	Finish
1600T6102ARI-42	1.1 gpf	594.15	-

- Electronic concealed flush valve rough
- Order 1600T6102ATR-42 trim separately
- Supplied as complete flush valve and wall access frame
- Hands-free operation
- H₂Optics® Sensing Technology
- For 1 1/2" back inlet wall hung water closet fixture
- Factory set flow rate, NOT field adjustable



H₂Optics® Concealed Flush Valve Trim



Model	Flow	Price	Finish
1600T6102ATR-42	1.1 gpf	594.15	-

- Electronic concealed flush valve trim
- Order 1600T6102ARI-42 rough separately
- Supplied as sensor, hardwire converter, solenoid and 14" x 20" stainless steel cover
- Hands-free operation
- H₂Optics® Sensing Technology
- For 1 1/2" back inlet wall hung water closet fixture
- Hardwire, order transformer separately
- Hardwire with battery back-up, order 061047A; transformer required
- Factory set flow rate, NOT field adjustable



H₂Optics® Concealed Flush Valve Rough



Model	Flow	Price	Finish
1600T6103ARI	1.6 gpf	594.15	-

- Electronic concealed flush valve rough
- Order 1600T6103ATR trim separately
- Supplied as complete flush valve and wall access frame
- Hands-free operation
- H₂Optics® Sensing Technology
- For 1 1/2" back inlet wall hung water closet fixture
- Factory set flow rate, field adjustable



H₂Optics® Concealed Flush Valve Trim



Model	Flow	Price	Finish
1600T6103ATR	1.6 gpf	586.90	-

- Electronic concealed flush valve trim
- Order 1600T6103ARI rough separately
- Supplied as sensor, hardwire converter, solenoid and 14" stainless steel cover
- Hands-free operation
- H₂Optics® Sensing Technology
- For 1 1/2" back inlet wall hung water closet fixture
- Hardwire, order transformer separately
- Hardwire with battery backup, order 061047A, transformer required
- Factory set flow rate, field adjustable



H₂Optics® Concealed Valve Rough for Washdown Urinals



Model	Flow	Price	Finish
1600T9001RI	0.5 gpf	463.75	-

- Electronic concealed flush valve rough-in for washdown urinals
- Order 1600T9001TR trim separately
- Supplied as wall box, stop and outlet hose
- Hands-free operation
- H₂Optics® Sensing Technology
- For 3/4" back inlet
- Factory set flow rate, field adjustable



H₂Optics® Concealed Valve Trim for Washdown Urinals



Model	Flow	Price	Finish
1600T9001TR	0.5 gpf	463.75	-

- Electronic concealed flush trim rough-in for washdown urinals
- Order 1600T9001RI rough separately
- Supplied as sensor, hardwire converter, solenoid and 10" stainless steel cover
- Hands-free operation
- H₂Optics® Sensing Technology
- For 3/4" back inlet
- Hardwire, order transformer separately
- Hardwire with battery backup order 061047A; transformer required



Electronic Washdown Urinal Valve



Model	Flow	Price	Finish
DEMD-86505	0.5 gpf	565.70	Chrome

- Electronic washdown urinal valve less vacuum breaker
- Hands-free operation
- Battery operated, batteries included
- Factory set flow rate, field adjustable
- Installation Warning: Model shown must be installed on a fixture providing sufficient air gap protection against backflow



Electronic Washdown Urinal Valve



Model	Flow	Price	Finish
DEMD-86515	0.5 gpf	597.85	Chrome

- Electronic washdown urinal valve with vacuum breaker
- Hands-free operation
- Battery operated, batteries included
- Factory set flow rate, field adjustable



Washdown Urinal Valve



Model	Flow	Price	Finish
86T505	0.5 gpf	202.70	Chrome

- Cast urinal valve
- For washdown urinal only
- 1/2" back inlet stop
- Vandal resistant handle
- Metering, slow-close lever style
- For 3/4" IP spud
- Factory set flow rate, field adjustable
- Installation Warning: Model shown above must be installed on a fixture providing sufficient air gap protection against backflow



Single Handle Centerset Bathroom Faucet



Model	Flow	Price	Finish
501LF-HDF	1.2 gpm	183.35	Chrome
501LF-HGMHDF	0.5 gpm	186.40	Chrome
501LF-TGMHDF	0.35 gpm	186.40	Chrome

501LF-HGMHDF and 501LF-TGMHDF are not WaterSense® Labeled

- 2-hole 4" installation
- 5" long, 4 7/8" high
- Rigid spout
- Solid brass fabricated body
- Vandal resistant lever handle and aerator
- Red/blue indicators
- Adjustable handle limit stop
- Less pop-up
- No lift rod hole
- 2" max. deck thickness
- 3/8" OD straight, copper supply tubes with 1/2" IPS fittings
- DIAMOND™ Valve



Single Handle Centerset Bathroom Faucet



Model	Flow	Price	Finish
520LF-HDF	1.2 gpm	215.45	Chrome
520LF-HGMHDF	0.5 gpm	218.75	Chrome
520LF-TGMHDF	0.35 gpm	218.75	Chrome

520LF-HGMHDF and 520LF-TGMHDF are not WaterSense® Labeled

- 3-hole 4" installation
- 5" long, 4 7/8" high
- Rigid spout
- Solid brass fabricated body
- Vandal resistant lever handle and aerator
- Red/blue indicators
- Adjustable handle limit stop
- Metal pop-up with angled lift-rod
- 2" max. deck thickness
- 3/8" OD straight, copper supply tubes with 1/2" IPS fittings
- DIAMOND™ Valve



Single Handle Centerset Bathroom Faucet



Model	Flow	Price	Finish
523LF-HDF	1.2 gpm	209.70	Chrome
523LF-HGMHDF	0.5 gpm	212.95	Chrome
523LF-TGMHDF	0.35 gpm	212.95	Chrome

523LF-HGMHDF and 523LF-TGMHDF are not WaterSense® Labeled

- 2-hole 4" installation
- 5" long, 4 7/8" high
- Rigid spout
- Solid brass fabricated body
- Vandal resistant lever handle and aerator
- Red/blue indicators
- Adjustable handle limit stop
- Metal grid strainer
- No lift rod hole
- 2" max. deck thickness
- 3/8" OD straight, copper supply tubes with 1/2" IPS fittings
- DIAMOND™ Valve



Single Handle Centerset Bathroom Faucet



Model	Flow	Price	Finish
511LF-HDF	1.2 gpm	197.95	Chrome
511LF-HGMHDF	0.5 gpm	200.85	Chrome

511LF-HGMHDF is not WaterSense® Labeled

- 2-hole 4" installation
- 5" long, 7 3/8" high
- Rigid spout
- Solid brass fabricated body
- Vandal resistant elbow handle and aerator
- Red/blue indicator
- Adjustable handle limit stop
- No lift rod hole
- 2" max. deck thickness
- 3/8" OD straight, copper supply tubes with 1/2" IPS fittings
- DIAMOND™ Valve



Single Handle Centerset Bathroom Faucet



Model	Flow	Price	Finish
515LF-HDF	1.2 gpm	229.60	Chrome

- 3-hole 4" installation
- 5" long, 7 3/8" high
- Rigid spout
- Solid brass fabricated body
- Vandal resistant elbow handle and aerator
- Red/blue indicator
- Adjustable handle limit stop
- Metal pop-up
- 2" max. deck thickness
- 3/8" OD straight, copper supply tubes with 1/2" IPS fittings
- DIAMOND™ Valve



Single Handle Centerset Bathroom Faucet



Model	Flow	Price	Finish
516LF-HDF	1.2 gpm	223.35	Chrome
516LF-HGMHDF	0.5 gpm	226.40	Chrome

516LF-HGMHDF is not WaterSense® Labeled

- 2-hole 4" installation
- 5" long, 7 3/8" high
- Rigid spout
- Solid brass fabricated body
- Vandal resistant elbow handle and aerator
- Red/blue indicator
- Adjustable handle limit stop
- Metal grid strainer
- 2" max. deck thickness
- 3/8" OD straight, copper supply tubes with 1/2" IPS fittings
- DIAMOND™ Valve



Single Handle Centerset Bathroom Faucet



Model	Flow	Price	Finish
22C101	1.5 gpm	209.35	Chrome

- 3-hole 4" installation
- 5 9/10" long, 5 1/3" high
- Cast brass body
- Vandal resistant lever handle and aerator with wrench flats
- Red/blue indicator
- 1 1/5" max. deck thickness
- 1/2" IPS shanks
- No lift rod hole
- Ceramic cartridge with rotational limit stop



Single Handle Centerset Bathroom Faucet



Model	Flow	Price	Finish
22C301	1.5 gpm	247.70	Chrome

- 3-hole 4" installation
- 5 9/10" long, 5 1/3" high
- Cast brass body
- Vandal resistant lever handle and aerator with wrench flats
- Red/blue indicator
- 1 1/5" max. deck thickness
- 1/2" IPS shanks
- Metal pop-up
- Ceramic cartridge with rotational limit stop



Single Handle Centerset Bathroom Faucet



Model	Flow	Price	Finish
22C401	1.5 gpm	234.80	Chrome

- 3-hole 4" installation
- 5 9/10" long, 5 1/3" high
- Cast brass body
- Vandal resistant lever handle and aerator with wrench flats
- Red/blue indicator
- 1 1/5" max. deck thickness
- 1/2" IPS shanks
- Metal grid strainer
- Ceramic cartridge with rotational limit stop



Single Handle Single Hole Bathroom Faucet



Model	Flow	Price	Finish
22C601	1.5 gpm	231.65	Chrome

- 1-hole installation
- 5 1/3" long, 5 1/3" high
- Cast brass body
- Vandal resistant lever handle and aerator with wrench flats
- Red/blue indicator
- 2 1/8" max. deck thickness
- 3/8" compression fittings
- No lift rod hole
- Optional 8" coverplate 061270A available
- Ceramic cartridge with rotational limit stop



Single Handle Single Hole Bathroom Faucet



Model	Flow	Price	Finish
22C801	1.5 gpm	259.90	Chrome

- 1-hole installation
- 5 1/3" long, 5 1/3" high
- Cast brass body
- Vandal resistant lever handle and aerator with wrench flats
- Red/blue indicator
- 2 1/8" max. deck thickness
- 3/8" compression fittings
- Metal pop-up
- Optional 8" coverplate 061270A available
- Ceramic cartridge with rotational limit stop



Two Handle Centerset Bathroom Faucet



Model	Flow	Price	Finish
2529LF-HDF	1.2 gpm	255.15	Chrome

- 2-hole 4" installation
- 5 1/4" long, 3 1/4" high
- Solid brass fabricated body
- Vandal resistant wrist blade handles & aerator
- Red/blue indicators
- Grid strainer
- No lift rod hole
- 1/2" IPS shanks
- 1 11/16" max. deck thickness



Two Handle Centerset Bathroom Faucet



Model	Flow	Price	Finish
2529LF-HDM	1.2 gpm	272.10	Chrome

- 3-hole 4" installation
- 5 1/4" long, 3 1/4" high
- Solid brass fabricated body
- Vandal resistant wrist blade handles & aerator
- Red/blue indicators
- Metal pop-up
- 1/2" IPS shanks
- 1 11/16" max. deck thickness



Two Handle Centerset Bathroom Faucet



Model	Flow	Price	Finish
2529LF-LGHDF	1.2 gpm	216.80	Chrome

- 2-hole 4" installation
- 5 1/4" long, 3 1/4" high
- Solid brass fabricated body
- Vandal resistant wrist blade handles & aerator
- Red/blue indicators
- Less grid strainer
- No lift rod hole
- 1/2" IPS shanks
- 1 11/16" max. deck thickness



Two Handle Centerset Bathroom Faucet



Model	Flow	Price	Finish
2529LF-LGHGMHDF	0.5 gpm	220.15	Chrome

- 2-hole 4" installation
- 5 1/4" long, 3 1/4" high
- Solid brass fabricated body
- Vandal resistant wrist blade handles & pressure compensating aerator
- Red/blue indicators
- Less grid strainer
- No lift rod hole
- 1/2" IPS shanks
- 1 11/16" max. deck thickness



Two Handle Centerset Bathroom Faucet



Model	Flow	Price	Finish
21C122	1.5 gpm	217.10	Chrome
21C132	1.5 gpm	205.65	Chrome
21C142	1.5 gpm	201.15	Chrome

- 2-hole 4" installation
- 5 1/10" long, 3 3/5" high
- Cast brass body
- Vandal resistant hooded blade handles
- Red/blue indicators
- 21C122 - Vandal resistant Agion® antimicrobial laminar outlet
- 21C132 - Vandal resistant aerator
- 21C142 - Standard aerator
- No lift rod hole
- 1 3/4" max. deck thickness
- CER-TECK® cartridges



Two Handle Centerset Bathroom Faucet



Model	Flow	Price	Finish
21C133	1.5 gpm	204.00	Chrome
21C143	1.5 gpm	199.50	Chrome

- 2-hole 4" installation
- 5 1/10" long, 3 3/5" high
- Cast brass body
- Vandal resistant lever handles
- Red/blue indicators
- 21C133 - Vandal resistant aerator
- 21C143 - Standard aerator
- No lift rod hole
- 1 3/4" max. deck thickness
- CER-TECK® cartridges



Two Handle Centerset Bathroom Faucet



Model	Flow	Price	Finish
21C134	1.5 gpm	240.25	Chrome
21C144	1.5 gpm	235.50	Chrome

- 2-hole 4" installation
- 5 1/10" long, 3 3/5" high
- Cast brass body
- Vandal resistant sanitary hood blade handles
- Red/blue indicators
- 21C134 - Vandal resistant aerator
- 21C144 - Standard aerator
- No lift rod hole
- 1 3/4" max. deck thickness
- CER-TECK® cartridges



Two Handle Centerset Bathroom Faucet



Model	Flow	Price	Finish
21C233	1.5 gpm	271.10	Chrome

- 3-hole 4" installation
- 5 1/10" long, 3 3/5" high
- Cast brass body
- Vandal resistant lever handles and aerator
- Red/blue indicators
- Metal pop-up
- 1 3/4" max. deck thickness
- CER-TECK® cartridges



Two Handle Centerset Bathroom Faucet



Model	Flow	Price	Finish
21C133-TI	1.5 gpm	217.50	Chrome

- 2-hole 4" installation
- 5 1/10" long, 3 3/5" high
- Cast brass body
- Vandal resistant lever handles and aerator
- Red/blue indicators
- No lift rod hole
- 1 3/4" max. deck thickness
- CER-TECK® cartridges



Two Handle Widespread Bathroom Faucet



Model	Flow	Price	Finish
3549LF-WFLGHDF	1.2 gpm	361.10	Chrome

- 3-hole 6"-16" installation
- 5 1/4" long, 3 13/16" high
- Solid brass fabricated end valves and spout body
- Vandal resistant wrist blade handles & aerator
- Red/blue indicators
- 1/4 turn handle stops
- Less grid strainer
- No lift rod hole
- 1 1/8" max. deck thickness
- WF = 1/2" IPS adapters
- Brass stems / stainless steel plate



Two Handle Widespread Bathroom Faucet



Model	Flow	Price	Finish
23C332	1.5 gpm	326.20	Chrome
23C342	1.5 gpm	339.55	Chrome

- 3-hole 6"-12" installation
- 4 1/2" long, 2 3/5" high
- Rigid cast spout
- Vandal resistant hooded blade handles
- Red/blue indicators
- 23C332 - Vandal resistant aerator
- 23C342 - Standard aerator
- No lift rod hole
- CER-TECK® cartridges



Two Handle Widespread Bathroom Faucet



Model	Flow	Price	Finish
23C333	1.5 gpm	324.65	Chrome

- 3-hole 6"-12" installation
- 4 1/2" long, 2 3/5" high
- Rigid cast spout
- Vandal resistant lever handles and aerator
- Red/blue indicators
- No lift rod hole
- CER-TECK® cartridges



Two Handle Widespread Bathroom Faucet



Model	Flow	Price	Finish
23C334	1.5 gpm	367.55	Chrome

- 3-hole 6"-12" installation
- 4 1/2" long, 2 3/5" high
- Rigid cast spout
- Vandal resistant sanitary hood blade handles and aerator
- Red/blue indicators
- No lift rod hole
- CER-TECK® cartridges



Two Handle Widespread Bathroom Faucet



Model	Flow	Price	Finish
23C632	1.5 gpm	303.80	Chrome
23C642	1.5 gpm	299.30	Chrome

- 3-hole 6"-12" installation
- 4 1/2" long, 12" high
- Rigid / swivel gooseneck spout
- Vandal resistant hooded blade handles
- Red/blue indicators
- 23C632 - Vandal resistant aerator
- 23C642 - Standard aerator
- CER-TECK® cartridges



Two Handle Widespread Bathroom Faucet



Model	Flow	Price	Finish
23C643	1.5 gpm	297.75	Chrome

- 3-hole 6"-12" installation
- 4 1/2" long, 12" high
- Rigid / swivel gooseneck spout
- Vandal resistant lever handles
- Red/blue indicators
- Standard aerator
- CER-TECK® cartridges



Two Handle Widespread Bathroom Faucet



Model	Flow	Price	Finish
23C624	1.5 gpm	356.05	Chrome
23C634	1.5 gpm	325.90	Chrome
23C644	1.5 gpm	339.15	Chrome

- 3-hole 6"-12" installation
- 4 1/2" long, 12" high
- Rigid / swivel gooseneck spout
- Vandal resistant sanitary hood blade handles
- Red/blue indicators
- 23C624 - Vandal resistant Agion® antimicrobial laminar outlet
- 23C634 - Vandal resistant aerator
- 23C644 - Standard aerator
- CER-TECK® cartridges



Two Handle Widespread Bathroom Faucet



Model	Flow	Price	Finish
3579LF-WFLGHDF	1.2 gpm	376.30	Chrome

- 3-hole 6"-16" installation
- 5 3/4" long, 11" high
- Rigid gooseneck spout
- Solid brass fabricated end valves and spout body
- Red/blue indicators
- 1/4 turn handle stops
- Less grid strainer
- Laminar flow outlet
- 1 1/8" max. deck thickness
- WF = 1/2" IPS adapters
- Brass stems / stainless steel plate



Commercial Single Handle Kitchen Faucet



Model	Flow	Price	Finish
100LF-HDF	1.5 gpm	185.95	Chrome

- 3-hole 8" installation
- 8 11/16" long, 8 1/2" high
- Vandal resistant handle and aerator
- Red/blue indicator
- 2 1/2" max. deck thickness
- Straight, staggered supply tubes
- 3/8" O.D. inlets with 3/8" fittings, includes 1/2" adapters
- DIAMOND™ Valve



Commercial Single Handle Kitchen Faucet



Model	Flow	Price	Finish
101LF-HDF	1.5 gpm	187.65	Chrome

- 1-hole installation
- 8 11/16" long, 8" high
- Vandal resistant handle and aerator
- Red/blue indicator
- 2 1/2" max. deck thickness
- Straight, staggered supply tubes
- 3/8" O.D. inlets with 3/8" fittings, includes 1/2" adapters
- DIAMOND™ Valve



Commercial Single Handle Kitchen Faucet with Spray



Model	Flow	Price	Finish
400LF-HDF	1.5 gpm	226.50	Chrome

- 4-hole 8" installation
- 8 11/16" long, 8 1/2" high
- Vandal resistant handle and aerator
- Red/blue indicator
- 2 1/2" max. deck thickness
- Straight, staggered supply tubes
- 3/8" O.D. inlets with 3/8" fittings, includes 1/2" adapters
- DIAMOND™ Valve



Commercial Two Handle Kitchen Faucet



Model	Flow	Price	Finish
26C3132	1.5 gpm	298.35	Chrome
26C3142	1.5 gpm	294.00	Chrome

- 3-hole 8" installation
- 8" long, 6 3/5" high
- Spout swings 360°
- Cast body
- 5 1/3" from deck to aerator
- Vandal resistant hooded blade handles
- Red/blue indicators
- 26C3132 - Vandal resistant aerator
- 26C3142 - Standard aerator
- 1/2" IPS shanks
- 1 3/4" max. deck thickness
- CER-TECK® cartridges



Commercial Two Handle Kitchen Faucet



Model	Flow	Price	Finish
26C3133	1.5 gpm	296.75	Chrome
26C3143	1.5 gpm	292.25	Chrome

- 3-hole 8" installation
- 8" long, 6 3/5" high
- Spout swings 360°
- Cast body
- 5 1/3" from deck to aerator
- Vandal resistant lever handles
- Red/blue indicators
- 26C3133 - Vandal resistant aerator
- 26C3143 - Standard aerator
- 1/2" IPS shanks
- 1 3/4" max. deck thickness
- CER-TECK® cartridges



Commercial Two Handle Kitchen Faucet



Model	Flow	Price	Finish
26C3124	1.5 gpm	331.95	Chrome
26C3134	1.5 gpm	320.55	Chrome
26C3144	1.5 gpm	333.45	Chrome

- 3-hole 8" installation
- 8" long, 6 3/5" high
- Spout swings 360°
- Cast body
- 5 1/3" from deck to aerator
- Vandal resistant sanitary hood blade handles
- Red/blue indicators
- 26C3124 - Vandal resistant Agion® antimicrobial laminar outlet
- 26C3134 - Vandal resistant aerator
- 26C3144 - Standard aerator
- 1/2" IPS shanks
- 1 3/4" max. deck thickness
- CER-TECK® cartridges



Commercial Two Handle Kitchen Faucet



Model	Flow	Price	Finish
26C3933	1.5 gpm	302.70	Chrome
26C3943	1.5 gpm	298.25	Chrome

- 3-hole 8" installation
- 6" long, 11 3/5" high
- Rigid / swivel gooseneck spout
- Cast body
- Vandal resistant lever handles
- Red/blue indicators
- 26C3933 - Vandal resistant aerator
- 26C3943 - Standard aerator
- 1/2" IPS shanks
- 1 3/4" max. deck thickness
- CER-TECK® cartridges



Commercial Two Handle Kitchen Faucet



Model	Flow	Price	Finish
26C3924	1.5 gpm	356.55	Chrome
26C3934	1.5 gpm	344.45	Chrome
26C3944	1.5 gpm	339.70	Chrome

- 3-hole 8" installation
- 6" long, 11 3/5" high
- Rigid / swivel gooseneck spout
- Cast body
- Vandal resistant sanitary hood blade handles
- Red/blue indicators
- 26C3924 - Vandal resistant Agion® antimicrobial laminar outlet
- 26C3934 - Vandal resistant aerator
- 26C3944 - Standard aerator
- 1/2" IPS shanks
- 1 3/4" max. deck thickness
- CER-TECK® cartridges



Commercial Two Handle Kitchen Faucet



Model	Flow	Price	Finish
27C2933	1.5 gpm	314.45	Chrome

- 3-hole 8" installation
- 6" long, 11 4/5" high
- Rigid / swivel gooseneck spout
- Below deck mount
- Vandal resistant lever handles
- Red/blue indicators
- 27C2933 - Vandal resistant aerator
- 1" max. deck thickness
- CER-TECK® cartridges



Commercial Two Handle Kitchen Faucet



Model	Flow	Price	Finish
27C2932	1.5 gpm	316.20	Chrome
27C2942	1.5 gpm	311.55	Chrome

- 3-hole 8" installation
- 6" long, 11 4/5" high
- Rigid / swivel gooseneck spout
- Below deck mount
- Vandal resistant hooded blade handles
- Red/blue indicators
- 27C2932 - Vandal resistant aerator
- 27C2942 - Standard aerator
- 1" max. deck thickness
- CER-TECK® cartridges



Commercial Two Handle Kitchen Faucet



Model	Flow	Price	Finish
27C2924	1.5 gpm	351.60	Chrome
27C2944	1.5 gpm	334.85	Chrome

- 3-hole 8" installation
- 6" long, 11 4/5" high spout
- Rigid / swivel gooseneck spout
- Below deck mount
- Vandal resistant sanitary hood blade handles
- Red/blue indicators
- 27C2924 - Vandal resistant Agion® antimicrobial laminar outlet
- 27C2944 - Standard aerator
- 1" max. deck thickness
- CER-TECK® cartridges



Commercial Two Handle Kitchen Faucet



Model	Flow	Price	Finish
27C2974	1.0 gpm	351.60	Chrome

- 3-hole 8" installation
- 6" long, 11 4/5" high
- Rigid / swivel gooseneck spout
- Below deck mount
- Vandal resistant sanitary hood blade handles
- Red/blue indicators
- Smooth spout end with laminar flow control in spout base
- 1" max. deck thickness
- CER-TECK® cartridges



Commercial Two Handle Bar Faucet



Model	Flow	Price	Finish
2171LF-WBHDF	1.5 gpm	235.65	Chrome

- 2-hole 4" installation
- 4 5/32" long, 11" high
- Gooseneck spout swings 360°
- Vandal resistant wrist blade handles
- Red/blue indicators
- Vandal resistant aerator
- 1/2" IPS shanks
- 1" max. deck thickness
- 1/4 turn stops
- Brass stems / stainless steel plate



Commercial Two Handle Bar Faucet



Model	Flow	Price	Finish
27C4822	1.5 gpm	271.95	Chrome
27C4832	1.5 gpm	259.80	Chrome
27C4842	1.5 gpm	255.10	Chrome

- 2-hole 4" installation
- 4 1/2" long, 11 3/4" high
- Rigid / swivel gooseneck spout
- Cast body
- Vandal resistant hooded blade handles
- Red/blue indicators
- 27C4822 - Vandal resistant Agion® antimicrobial laminar outlet
- 27C4832 - Vandal resistant aerator
- 27C4842 - Standard aerator
- 1/2" IPS shanks
- 1 3/4" max. deck thickness
- CER-TECK® cartridges



Commercial Two Handle Bar Faucet



Model	Flow	Price	Finish
27C4943	1.5 gpm	253.40	Chrome

- 2-hole 4" installation
- 6" long, 11 3/5" high
- Rigid / swivel gooseneck spout
- Cast body
- Vandal resistant lever handles
- Red/blue indicators
- Standard aerator
- 1/2" IPS shanks
- 1 3/4" max. deck thickness
- CER-TECK® cartridges



Commercial Two Handle Bar Faucet



Model	Flow	Price	Finish
27C4924	1.5 gpm	304.15	Chrome
27C4934	1.5 gpm	319.10	Chrome
27C4944	1.5 gpm	278.45	Chrome

- 2-hole 4" installation
- 6" long, 11 3/5" high
- Rigid / swivel gooseneck spout
- Cast body
- Vandal resistant sanitary hood blade handles
- Red/blue indicators
- 27C4924 - Vandal resistant Agion® antimicrobial laminar outlet
- 27C4934 - Vandal resistant aerator
- 27C4944 - Standard aerator
- 1/2" IPS shanks
- 1 3/4" max. deck thickness
- CER-TECK® cartridges



Commercial Two Handle Bar Faucet



Model	Flow	Price	Finish
25C3837	1.5 gpm	316.35	Chrome
25C3847	1.5 gpm	311.65	Chrome

- 1-hole installation
- 4 1/2" long, 14" high
- Rigid / swivel gooseneck spout
- Vandal resistant ADA lever balanced handles
- Red/blue indicators
- 25C3837 - Vandal resistant aerator
- 25C3847 - Standard aerator
- 3/8" compression fittings
- 2" max. deck thickness
- CER-TECK® cartridges



Commercial Two Handle Bar Faucet



Model	Flow	Price	Finish
25C3877	1.0 gpm	328.45	Chrome

- 1-hole installation
- 4 1/2" long, 14" high
- Rigid / swivel gooseneck spout
- Vandal resistant ADA lever balanced handles
- Red/blue indicators
- Smooth spout end with laminar flow control in spout base
- 3/8" compression fittings
- 2" max. deck thickness
- CER-TECK® cartridges



Commercial Service Sink Faucet

Model	Flow	Price	Finish
28T9	-	214.60	Rough Chrome

- Wall installation - 8" centers
- 9 1/2" long vacuum breaker spout
- Rigid spout with top brace
- Cast body
- Cross handles
- Red/blue indicators
- Hose thread outlet
- Vacuum breaker
- Integral stops
- Not for potable water
- Heavy duty cartridges



Commercial Service Sink Faucet



Model	Flow	Price	Finish
28C2383	-	472.50	Chrome

- Wall installation - 8" centers
- 8" long vacuum breaker spout
- Rigid spout with top / bottom brace
- Cast body
- Vandal resistant lever handles
- Red/blue indicators
- Hose thread outlet
- Vacuum breaker
- Integral check stops
- Not for potable water
- CER-TECK® cartridges



Commercial Wallmount Sink Faucet



Model	Flow	Price	Finish
28C4433	1.5 gpm	338.55	Chrome

- Wall installation - 8" centers
- 11" long spout swings 360°
- Swing spout
- Cast body
- Vandal resistant lever handles and aerator
- Red/blue indicators
- Less integral stops
- For commercial use only
- CER-TECK® cartridges



Commercial Wallmount Sink Faucet



Model	Flow	Price	Finish
28P4902LF	1.5 gpm	257.60	Chrome

- Wall installation - 8" centers
- 8" gooseneck spout swings 360°
- Gooseneck swing spout
- Cast body
- Supplied with adjustable centers - 6.87" to 9.25"
- Vandal resistant hooded blade handles and aerator
- Red/blue indicators
- Less integral stops
- Control mechanism is 1/4 turn cylinder with brass stem, stainless steel plate and non-metallic seats



Commercial Wallmount Sink Faucet



Model	Flow	Price	Finish
28P4402LF	1.5 gpm	257.60	Chrome

- Wall installation - 8" centers
- 8" long spout swings 360°
- Swing spout
- Cast body
- Supplied with adjustable centers - 6.87" to 9.25"
- Vandal resistant hooded blade handles and aerator
- Red/blue indicators
- Less integral stops
- Control mechanism is 1/4 turn cylinder with brass stem, stainless steel plate and non-metallic seats



Commercial Wallmount Sink Faucet



Model	Flow	Price	Finish
28P4202LF	1.5 gpm	257.60	Chrome

- Wall installation - 8" centers
- 9 1/2" long spout swings 360°
- Swing spout
- Cast body
- Supplied with adjustable centers - 6.87" to 9.25"
- Vandal resistant hooded blade handles and aerator
- Red/blue indicators
- Less integral stops
- Control mechanism is 1/4 turn cylinder with brass stem, stainless steel plate and non-metallic seats



Single Handle Bar / Prep Sink Faucet



Model	Flow	Price	Finish
710LF-HDF	1.5 gpm	307.60	Chrome

- 2-hole installation
- 5 7/32" long, 10 11/64" high rigid gooseneck spout
- Vandal resistant elbow handle and outlet
- Red/blue indicators
- Adjustable handle limit stop
- 2 1/2" max. deck thickness
- 3/8" OD straight, staggered copper supply tubes with 3/8" fittings
- DIAMOND™ Valve



Single Handle Basin Faucet



Model	Flow	Price	Finish
570LF-06ELH	1.2 gpm	214.30	Chrome

- 1-hole installation
- 6" long, 8 3/4" high
- Swing spout
- Vandal resistant elbow handle and aerator
- Red/blue indicators
- Adjustable handle limit stop
- 1 9/16" max. deck thickness
- Straight, staggered supply tubes with 1/2" IPS adapters
- Order RP63131 for 8" spout
- Stainless steel ball



Single Handle Metering Faucet



Model	Flow	Price	Finish
701LF-HDF	0.5 gpm	174.85	Chrome

- 1-hole installation
- 4 1/4" long, 3 1/2" high
- Vandal resistant handle
- Metering, slow-close push style
- 1 1/8" max. deck thickness
- Vandal resistant spray outlet - see (1) below
- 1/2" threaded male inlet shank



Two Handle Centerset Metering Faucet



Model	Flow	Price	Finish
2507LF-HDF	0.5 gpm	305.15	Chrome

- 2 or 3-hole 4" installation
- 5" long, 2 3/4" high
- Vandal resistant handles
- Metering, slow-close push style
- Hot/cold indicators
- No lift rod hole
- 1 3/8" max. deck thickness
- Vandal resistant spray outlet - see (1) below
- 1/2" IPS shanks



Single Handle Metering Faucet



Model	Flow	Price	Finish
87T104	0.5 gpm	183.95	Chrome
87T110	0.5 gpm	225.80	Chrome

- 1-hole installation
- Cast brass body
- Vandal resistant push button
- Metering, slow-close push style
- 2 1/2" max. deck thickness
- 87T104 - Single inlet
- 87T110 - Mixing tee and checks
- Vandal resistant spray outlet - see (1) below



Single Handle Metering Faucet



Model	Flow	Price	Finish
87T105	0.5 gpm	196.80	Chrome
87T111	0.5 gpm	239.35	Chrome

- 1-hole installation
- Cast brass body
- Vandal resistant ADA lever handles
- Metering, slow-close lever style
- 2 1/2" max. deck thickness
- 87T105 - Single inlet
- 87T111 - Mixing tee and checks
- Vandal resistant spray outlet - See (1) below



Two Handle Centerset Metering Faucet



Model	Flow	Price	Finish
86T1153	0.5 gpm	326.40	Chrome

- 2-hole 4" installation
- Cast brass body
- Vandal resistant ADA lever handles
- Metering, slow-close lever style
- Red/blue indicators
- 2 3/8" max. deck thickness
- No lift rod hole
- Vandal resistant spray outlet - See (1) below

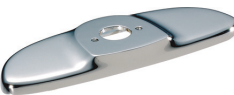

Centerset Coverplate

Model	Flow	Price	Finish
87T151	-	55.85	Chrome

- 4" centerset cover plate
- Cast brass
- Two hold-down shanks
- For 87T series
- Vandal resistant

See pages C1 and C11 for icon definitions. ASME A112.18.1/CSA B125.1.

(1) All Delta® metering, slow-close faucets shown on this page have a 0.5 gpm (1.9 L/min) flow control vandal resistant spray outlet. Each activation delivers no more than 1/4 gallon when not held open manually.



**Commercial
Pre-Rinse Wall Mount Faucet**



Model	Flow	Price	Finish
55C1513	1.05 gpm	826.15	Chrome

- Wall installation - 8" centers
- Cast body
- Vandal resistant lever handles
- Red/blue indicators
- High pressure hose
- Stainless steel hose shield
- Integral check stops
- For commercial use only
- 12" wall bracket - thin wall kit
- Insulated spray head with hook
- CER-TECK® cartridges



Grid Strainer

- 1 1/4" grid strainer
- Cast brass body
- Overflow holes

Model
33T260

Price
26.90

Finish
Chrome



Grid Strainer

- Offset grid strainer
- Cast brass body
- Overflow holes

Model
33T290

Price
50.50

Finish
Chrome



Cast P- Trap – Less Cleanout



- 1-1/4" cast P trap
- Cast brass body
- Adjustable
- Less cleanout plug
- Polished chrome plated

Model
33T301

Price
58.55

Finish
Chrome



Adjustable P-trap with Cleanout

- Adjustable P-trap with cleanout
- Cast brass waste bend
- Slip joint coupling nuts
- Deep, brass wall flange
- 1 1/4" size

Model
33T311

Price
60.05

Finish
Chrome



Adjustable P-trap with Cleanout

- Adjustable P-trap with cleanout
- Cast brass waste bend
- Slip joint coupling nuts
- Deep, brass wall flange
- 1 1/2" size

Model
33T360

Price
74.25

Finish
Chrome

How To Order a Complete MultiChoice® 13 or 17 Series Tub/Shower Faucet

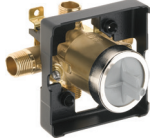
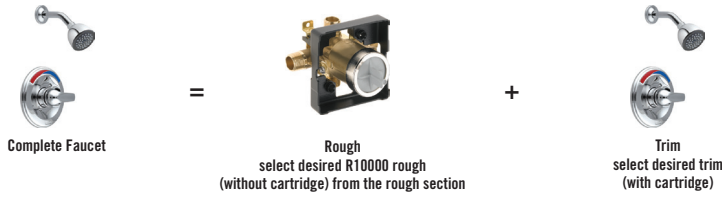

MultiChoice® Rough-Ins

Model	Flow	Price	Finish
R10000-UNWS	N/A	100.35	N/A

- Valve body only
- Accepts single-function (13/14), dual function (17), or dual function thermostatic (17T) cartridge
- Cartridge ships with trim
- 1/2" universal inlets accept 1/2" copper, 1/2" iron pipe, PEX or CPVC adaptors
- 1/2" universal outlets, inlets/outlets have male threads
- Back-to-back capability
- With stops



MultiChoice® Rough-Ins

Model	Flow	Price	Finish
R10700-UNWS	N/A	141.30	N/A

- For use with MultiChoice® Universal T13H and T17TH series with diverter valve for dual showers
- Handle and flange ships with trim
- Valve and diverter cartridges ship with trim kit
- With stops



Commercial Monitor® 13 Series Valve Only Trim

Model	Flow	Price	Finish
T13090	-	102.55	Chrome

- Single-function pressure balance cartridge
- Order MultiChoice® Universal rough separately
- Vandal resistant blade handle adjusts temperature
- Red/blue indicator
- RP77991 adds 1 3/4" to max. installation thickness



Commercial Monitor® 13 Series Shower Trim



Model	Flow	Price	Finish
T13290	1.75 gpm	123.70	Chrome

- Single-function pressure balance cartridge
- Order MultiChoice® Universal rough separately
- Vandal resistant blade handle adjusts temperature
- Red/blue indicator
- RP77991 adds 1 3/4" to max. installation thickness
- Touch-Clean® 5-setting shower head is WaterSense® labeled
- Full Body spray, Fast Massage spray, Full Spray with Massage, High Efficiency Spray, Pause



Commercial Monitor® 13 Series Tub & Shower Trim



Model	Flow	Price	Finish
T13490	1.75 gpm	154.30	Chrome

ADA for valve control only

- Single-function pressure balance cartridge
- Order MultiChoice® Universal rough separately
- Vandal resistant blade handle adjusts temperature
- Red/blue indicator
- RP77991 adds 1 3/4" to max. installation thickness
- 5" long pull-up diverter spout
- Tri-universal adapter for thread 1/2" IPS, sweat 1/2" C.W.T or slip onto 1/2" C.W.T
- Touch-Clean® 5-setting shower head is WaterSense® labeled
- Full Body spray, Fast Massage spray, Full Spray with Massage, High Efficiency Spray, Pause



Commercial Monitor® 13 Series Valve Only Trim

Model	Flow	Price	Finish
T13091	-	102.55	Chrome

- Single-function pressure balance cartridge
- Order MultiChoice® Universal rough separately
- Metal lever handle adjusts temperature
- Red/blue indicator
- RP77991 adds 1 3/4" to max. installation thickness



Commercial Monitor® 13 Series Shower Trim



Model	Flow	Price	Finish
T13291	1.75 gpm	123.70	Chrome

- Single-function pressure balance cartridge
- Order MultiChoice® Universal rough separately
- Metal lever handle adjusts temperature
- Red/blue indicator
- RP77991 adds 1 3/4" to max. installation thickness
- Touch-Clean® 5-setting shower head is WaterSense® labeled
- Full Body spray, Fast Massage spray, Full Spray with Massage, High Efficiency Spray, Pause



Commercial Monitor® 13 Series Shower Trim - Less Head



Model	Flow	Price	Finish
T13291-LHD	-	106.70	Chrome

- Single-function pressure balance cartridge
- Order MultiChoice® Universal rough separately
- Metal lever handle adjusts temperature
- Red/blue indicator
- RP77991 adds 1 3/4" to max. installation thickness
- Order shower head separately (LHD)



Commercial Monitor® 13 Series Tub & Shower Trim



Model	Flow	Price	Finish
T13491	1.75 gpm	154.30	Chrome

ADA for valve control only

- Single-function pressure balance cartridge
- Order MultiChoice® Universal rough separately
- Metal lever handle adjusts temperature
- Red/blue indicator
- RP77991 adds 1 3/4" to max. installation thickness
- 5" pull-up tub spout
- Tri-universal adapter for thread 1/2" IPS, sweat 1/2" C.W.T or slip onto 1/2" C.W.T
- Touch-Clean® 5-setting shower head is WaterSense® labeled
- Full Body spray, Fast Massage spray, Full Spray with Massage, High Efficiency Spray, Pause



Commercial Monitor® 13 Series Tub & Shower Trim - Less Head



Model	Flow	Price	Finish
T13491-LHD	-	138.10	Chrome

ADA for valve control only

- Single-function pressure balance cartridge
- Order MultiChoice® Universal rough separately
- Metal lever handle adjusts temperature
- Red/blue indicator
- RP77991 adds 1 3/4" to max. installation thickness
- 5" pull-up tub spout
- Tri-universal adapter for thread 1/2" IPS, sweat 1/2" C.W.T or slip onto 1/2" C.W.T
- Order shower head separately (LHD)



Commercial Monitor® 13 Series Valve Only Trim



Model	Flow	Price	Finish
T13391	-	102.55	Chrome

- Single-function pressure balance cartridge
- Order MultiChoice® Universal push-button rough separately
- Metal lever handle adjusts temperature
- Red/blue indicator
- Push-button diverter
- RP77991 adds 1 3/4" to max. installation thickness



Commercial Monitor® 13 Series Tub & Shower Trim



Model	Flow	Price	Finish
T13691	1.75 gpm	154.30	Chrome

ADA for valve control only

- Single-function pressure balance cartridge
- Order MultiChoice® Universal push-button rough separately
- Metal lever handle adjusts temperature
- Red/blue indicator
- Push-button diverter
- RP77991 adds 1 3/4" to max. installation thickness
- 4-3/4" metal non-diverter tub spout
- Thread onto 1/2" IPS
- Touch-Clean® 5-setting shower head is WaterSense® labeled
- Full Body spray, Fast Massage spray, Full Spray with Massage, High Efficiency Spray, Pause



**Commercial
13 Series Shower Trim**



Model	Flow	Price	Finish
T13H132	1.5 gpm	136.05	Chrome

- Single-function pressure balance cartridge
- Order MultiChoice® Universal rough separately
- Vandal resistant lever handle adjusts temperature
- Red/blue indicator
- RP77991 adds 1 3/4" to max. installation thickness
- Touch-Clean® full body shower head is WaterSense® labeled



**Commercial
13 Series Tub & Shower Trim**



Model	Flow	Price	Finish
T13H232	1.5 gpm	161.80	Chrome

ADA for valve control only

- Single-function pressure balance cartridge
- Order MultiChoice® Universal rough separately
- Vandal resistant lever handle adjusts temperature
- Red/blue indicator
- RP77991 adds 1 3/4" to max. installation thickness
- 4 3/4" metal pull-up tub spout
- Sweat spout onto 1/2" C.W.T. or thread onto 1/2" IPS
- Touch-Clean® full body shower head is WaterSense® labeled



**Commercial
13 Series Shower Trim**



Model	Flow	Price	Finish
T13H152	1.5 gpm	355.50	Chrome

- Single-function pressure balance cartridge
- Order MultiChoice® Universal rough separately
- Vandal resistant lever handle adjusts temperature
- Red/blue indicator
- 24" long, 1 1/2" stainless slide bar / grab bar
- 70" vinyl hose
- ADA adjustable mount, hand shower and hose
- ADA compliant grab bar when installed per accessibility guidelines of the act
- RP77991 adds 1 3/4" to max. installation thickness
- Touch-Clean® two-setting hand shower is WaterSense® labeled
- Pause, Full Body Spray



**Commercial
13 Series Shower Trim**



Model	Flow	Price	Finish
T13H163	1.5 gpm	302.25	Chrome

- Single-function pressure balance cartridge
- Order MultiChoice® Universal rough separately
- Vandal resistant blade handle adjusts temperature
- Red/blue indicator
- RP77991 adds 1 3/4" to max. installation thickness
- 30° vandal resistant cast shower head



**Commercial
13 Series Shower Trim**



Model	Flow	Price	Finish
T13H153	1.5 gpm	336.95	Chrome

ADA for valve control only

- Single-function pressure balance cartridge
- Order MultiChoice® Universal rough separately
- Vandal resistant blade handle adjusts temperature
- Red/blue indicator
- 24" long, 1 1/2" stainless slide bar / grab bar
- 70" vinyl hose
- ADA adjustable mount, hand shower and hose
- ADA compliant grab bar when installed per accessibility guidelines of the act
- RP77991 adds 1 3/4" to max. installation thickness
- Touch-Clean® two-setting hand shower is WaterSense® labeled
- Pause, Full Body Spray



**Commercial
13 Series Tub & Shower Trim**



Model	Flow	Price	Finish
T13H253	1.5 gpm	381.30	Chrome

ADA for valve control only

- Single-function pressure balance cartridge
- Order MultiChoice® Universal rough separately
- Vandal resistant blade handle adjusts temperature
- Red/blue indicator
- 24" long, 1 1/2" stainless slide bar / grab bar
- 70" vinyl hose
- ADA adjustable mount, hand shower and hose
- ADA compliant grab bar when installed per accessibility guidelines of the act
- RP77991 adds 1 3/4" to max. installation thickness
- Pull-up metal diverter spout
- Sweat spout onto 1/2" C.W.T. or thread onto 1/2" IPS
- Touch-Clean® two-setting hand shower is WaterSense® labeled
- Pause, Full Body Spray



**Commercial
13 Series Tub & Shower Trim**



Model	Flow	Price	Finish
T13H333	1.5 gpm	560.35	Chrome

ADA for valve control only

- Single-function pressure balance cartridge
- Diverter valve
- Order R10700-UNWS MultiChoice® Universal rough separately
- Vandal resistant blade handle adjusts temperature
- Red/blue indicator
- 24" long, 1 1/2" stainless slide bar / grab bar
- 70" vinyl hose
- ADA adjustable mount, hand shower and hose
- ADA compliant grab bar when installed per accessibility guidelines of the act
- Touch-Clean® full body shower head is WaterSense® labeled
- Touch-Clean® two-setting hand shower is WaterSense® labeled
- Pause, Full Body Spray



Commercial TempAssure® 17T Series Shower Trim



Model	Flow	Price	Finish
T17TH125	1.75 gpm	500.10	Chrome

ADA for valve control only

- Single-function thermostatic cartridge
- Order MultiChoice® Universal rough separately
- Vandal resistant handle adjusts volume
- Dial adjusts temperature
- Red/blue indicator
- Touch-Clean® 3-setting shower head is WaterSense® labeled
- Full Body Spray, Massage Spray, Soft-Drench Spray



Commercial TempAssure® 17T Series Shower Trim



Model	Flow	Price	Finish
T17TH155	2.5 gpm	669.65	Chrome

ADA for valve control only

- Single-function thermostatic cartridge
- Order MultiChoice® Universal rough separately
- Vandal resistant handle adjusts volume
- Dial adjusts temperature
- Red/blue indicator
- 24" long, 1 1/2" stainless slide bar / grab bar
- 70" vinyl hose
- ADA adjustable mount, hand shower and hose
- ADA compliant grab bar when installed per accessibility guidelines of the act
- Touch-Clean® two-setting hand shower
- Pause, Full Body Spray



Commercial Electronic Shower



Model	Flow	Price	Finish
860T167	1.5 gpm	1,563.10	Chrome

ADA for valve control only

- Recessed metal box mount with pressure balance mixing valve
- Electronic shower with push-button activator
- Vandal resistant handle adjusts temperature
- Red/blue indicator
- 30° vandal resistant cast shower head
- Hardwire, order transformer separately
- Hardwire with battery backup, order 061047A; transformer required



Commercial Low Profile Institutional Electronic Shower



Model	Flow	Price	Finish
860T178	1.5 gpm	1,563.10	Chrome

- Recessed metal box mount with thermostatic mixing valve
- Electronic shower with push-button activator
- Tempered water supplied to solenoid valve
- Field adjustable shower time
- 30° vandal resistant forged shower head is WaterSense® labeled
- Hardwire, order transformer separately
- Hardwire with battery backup, order 061047A; transformer required

Commercial Adjustable Slide Bar / Grab Bar Assembly

Model	Flow	Price	Finish
RPW124HDF	2.5 gpm	229.85	Stainless and White

- Two-setting white hand shower
- Two integral check valves for backflow prevention
- Touch-Clean® spray holes
- Push-button spray selection
- 24" long, 1 1/2" stainless slide bar / grab bar
- ADA adjustable mount, hand shower and hose
- ADA compliant grab bar when installed per accessibility guidelines of the act
- 60" - 82" stretchable metal hose
- Pause, Full Body Spray

Commercial Adjustable Slide Bar / Grab Bar Assembly

Model	Flow	Price	Finish
RPW136HDF	2.5 gpm	253.35	Stainless and White

- Two-setting white hand shower
- Two integral check valves for backflow prevention
- Touch-Clean® spray holes
- Push-button spray selection
- 36" long, 1 1/2" stainless slide bar / grab bar
- ADA adjustable mount, hand shower and hose
- ADA compliant grab bar when installed per accessibility guidelines of the act
- 60" - 82" stretchable metal hose
- Pause, Full Body Spray

Commercial Adjustable Slide Bar / Grab Bar Assembly

Model	Flow	Price	Finish
RPW324HDF	2.5 gpm	299.00	Stainless and White

- Two-setting white hand shower
- Two integral check valves for backflow prevention
- Touch-Clean® spray holes
- Push-button spray selection
- 24" long, 1 1/2" stainless slide bar / grab bar
- ADA adjustable mount, hand shower and hose
- ADA compliant grab bar when installed per accessibility guidelines of the act
- 60" - 82" stretchable metal hose
- 90° chrome wall supply elbow
- Pause, Full Body Spray

Commercial Adjustable Slide Bar / Grab Bar Assembly

Model	Flow	Price	Finish
RPW324HDF-1.5	1.5 gpm	293.10	Stainless and White

- Two-setting white hand shower
- Two integral check valves for backflow prevention
- Touch-Clean® spray holes
- Push-button spray selection
- 24" long, 1 1/2" stainless slide bar / grab bar
- ADA adjustable mount, hand shower and hose
- ADA compliant grab bar when installed per accessibility guidelines of the act
- 60" - 82" stretchable metal hose
- 90° chrome wall supply elbow
- Pause, Full Body Spray

Commercial Adjustable Slide Bar / Grab Bar Assembly - Less Hand Shower

Model	Flow	Price	Finish
RPW324HDF-LHD	-	282.05	Chrome

- 24" long, 1 1/2" stainless slide bar / grab bar
- ADA adjustable mount and hose
- ADA compliant grab bar when installed per accessibility guidelines of the act
- 60" - 82" stretchable metal hose
- 90° chrome wall supply elbow
- Order hand shower separately (LHD)

Commercial Adjustable Slide Bar / Grab Bar Assembly

Model	Flow	Price	Finish
RPW336HDF	2.5 gpm	322.60	Stainless and White

- Two-setting white hand shower
- Two integral check valves for backflow prevention
- Touch-Clean® spray holes
- Push-button spray selection
- 36" long, 1 1/2" stainless slide bar / grab bar
- ADA adjustable mount, hand shower and hose
- ADA compliant grab bar when installed per accessibility guidelines of the act
- 60" - 82" stretchable metal hose
- 90° chrome wall supply elbow
- Pause, Full Body Spray



Mechanical Mixer

- Mechanical mixer
- 2.0 gpm @ 60psi, 7.6 L/min @ 414kPa

Model	Flow	Price	Finish
R2910-MIXLF	-	82.95	-



Thermostatic Mixing Valve

- Thermostatic mixing valve
- IAPMO listed to ASSE 1070
- 3/8" compression inlets / outlets
- Check valves on inlets
- Min. 0.35 gpm, 1.3 L/min flow rate
- Max. flow of 5.8 gpm, 22 L/min @ 45 psi pressure loss

Model	Flow	Price	Finish
R3070-MIXLF	-	172.10	-



Thermostatic Mixing Valve

- Thermostatic mixing valve
- IAPMO listed to ASSE 1069, ASSE 1070
- 1/2" copper sweat inlets / outlets
- Check valves on inlets
- Min. 0.34 gpm, 1.29 L/min flow rate
- Max. 11.0 gpm, 42 L/min flow rate

Model	Flow	Price	Finish
R2570-MIXLF	-	212.35	-



Thermostatic Mixing Valve

- Thermostatic mixing valve
- IAPMO listed to ASSE 1070
- 3/8" compression inlets / outlets
- Check valves on inlets
- Min. 0.25 gpm, 1.0 L/min flow rate
- Max. flow of 2.5 gpm, 9.5 L/min @ 45 psi pressure loss

Model	Flow	Price	Finish
R3270-MIXLF	-	172.10	Chrome



Model Options

Delta® Commercial is known for its depth of commercial products that meet any project requirement. This section of the price book allows you to configure the product to your specific needs. And to top it off, we continue to support you by listing some of the most popular selling models within a series, along with a supplemental product list, rough-in, trim and add-on options. Delta® Commercial has the solutions to meet your current and future needs.

**Please always order in full case. Delta Commercial Technical Service 1-877-387-8277.
Online Catalog: deltafaucet.com (Complete Product Offering & Part Numbering System)**





MODEL NUMBER EXAMPLE:
Configurations vary, see below for availability.

590TF0128TR

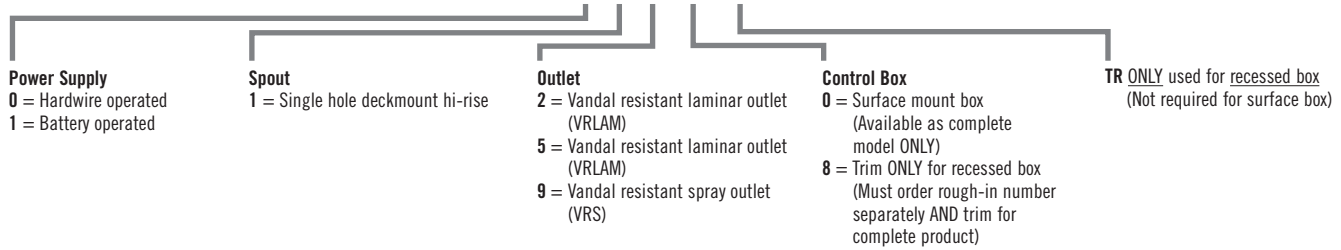

Surface Mount Box
(Available as complete models ONLY)

Model	Flow	Price	Finish
Hardwire Operated			
590TF0120	1.5 gpm (5.7 L/min) (VRLAM)	684.05	Chrome
590TF0150	0.5 gpm (1.9 L/min) (VRLAM)	684.05	Chrome
590TF0190	0.35 gpm (1.3 L/min) (VRS)	684.05	Chrome
Battery Operated			
590TF1120	1.5 gpm (5.7 L/min) (VRLAM)	684.05	Chrome
590TF1150	0.5 gpm (1.9 L/min) (VRLAM)	684.05	Chrome
590TF1190	0.35 gpm (1.3 L/min) (VRS)	684.05	Chrome

- 1-hole installation
- 5" long, 7" high
- Hands-free activation
- Adjustable sensing range, auto shut-off, metering mode and periodic rinse feature
- Mixing valve required
- 2.5" max deck thickness
- Order 060546A for 4" or 060547A for 8" optional coverplates
- Hardwire models, order transformer separately
- Battery operated, batteries included

Note: Available in Q4 2023



Trim ONLY for Recessed Box
(Must order rough-in number separately AND trim for complete product)

Model	Flow	Price	Finish
Hardwire Operated			
590TF0128TR	1.5 gpm (5.7 L/min) (VRLAM)	350.50	Chrome
590TF0158TR	0.5 gpm (1.9 L/min) (VRLAM)	350.50	Chrome
Battery Operated			
590TF1128TR	1.5 gpm (5.7 L/min) (VRLAM)	350.50	Chrome
590TF1158TR	0.5 gpm (1.9 L/min) (VRLAM)	350.50	Chrome
590TF1198TR	0.35 gpm (1.3 L/min) (VRS)	350.50	Chrome

- 1 hole installation
- 5" long, 7" high
- Hands-free activation
- Adjustable sensing range, auto shut-off, metering mode and periodic rinse feature
- 12" S/S cover, driver board, solenoid
- Requires separate order of rough-in for complete product
- Connection from box to spout not supplied
- 2.5" max deck thickness
- Order 060546A for 4" or 060547A for 8" optional coverplates
- Hardwire models, order transformer separately
- Battery operated, batteries included

Note: Available in Q4 2023

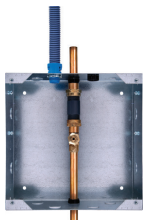

Rough-in ONLY – For Use with Trim
(Must order trim number separately AND rough-in for complete product)

Model	Flow	Price	Finish
ELAVT0001ARI	N/A	542.80	N/A

- Rough-in ONLY, NO mixing valve
- Recessed mount 10" x 10" box with single inlet supply
- Must order TRIM for complete model

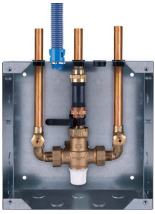

Rough-in ONLY – For Use with Trim
(Must order trim number separately AND rough-in for complete product)

Model	Flow	Price	Finish
ELAVT0008ARI	N/A	806.90	N/A

- Rough-in ONLY, with thermostatic mixing valve
- Recessed mount 10" x 10" box with thermostatic mixing valve
- Must order TRIM for complete model



Accessories for Field Conversion

Model	Flow	Price	Finish
061047A	N/A	71.25	N/A

- Hardwire converter with battery backup
- Order separately



Accessories for Field Conversion

Model	Flow	Price	Finish
060651A	N/A	249.45	N/A

- 3-position switch
- Refer to specification for applicable uses
- Order separately



Coverplate for Field Conversion

Model	Flow	Price	Finish
060546A	N/A	85.35	Chrome

- 4" (102 mm) coverplate



Coverplate for Field Conversion

Model	Flow	Price	Finish
060547A	N/A	109.65	Chrome

- 8" (204 mm) coverplate

See page C62 for available transformers.

MODEL NUMBER EXAMPLE:
Configurations vary, see below for availability.

590TPA0120-PI-TR

TR ONLY used for recessed box
(Not required for surface box)

Power Supply
0 = Hardwire operated
1 = Battery operated
2 = Plug-in power

Spout
1 = Single hole deck mount
hi-rise

Outlet
2 = Vandal resistant laminar
Agion® antimicrobial finish outlet (VRLAM)
5 = Vandal resistant laminar outlet (VRLAM)
9 = Vandal resistant spray outlet (VRS)

Control Box
0 = Surface mount box
(Available as complete
model ONLY)
8 = Trim ONLY for recessed box
(Must order rough-in number AND
trim, AC filter and transformer
separately for complete product)

PI = Plug-in power supply
LP = Less power (Must order
PI model separately)



590TPA Surface Mount Box
(Available as complete models ONLY)

Model	Flow	Price	Finish
Hardwire Operated			
590TPA0120	1.5 gpm (5.7 L/min) (VRLAM)	665.85	Chrome
590TPA0150	0.5 gpm (1.9 L/min) (VRLAM)	665.85	Chrome
590TPA0190	0.35 gpm (1.3 L/min) (VRS)	665.85	Chrome
Battery Operated			
590TPA1120	1.5 gpm (5.7 L/min) (VRLAM)	708.85	Chrome
590TPA1150	0.5 gpm (1.9 L/min) (VRLAM)	708.85	Chrome
590TPA1190	0.35 gpm (1.3 L/min) (VRS)	708.85	Chrome
Plug-in Power			
590TPA2120-PI	1.5 gpm (5.7 L/min) (VRLAM)	708.85	Chrome
590TPA2150-PI	0.5 gpm (1.9 L/min) (VRLAM)	708.85	Chrome
590TPA2190-PI	0.35 gpm (1.3 L/min) (VRS)	708.85	Chrome
Less Power			
590TPA2120-LP	1.5 gpm (5.7 L/min) (VRLAM)	675.75	Chrome
590TPA2150-LP	0.5 gpm (1.9 L/min) (VRLAM)	675.75	Chrome
590TPA2190-LP	0.35 gpm (1.3 L/min) (VRS)	675.75	Chrome

- 1- hole installation
- 5" long, 7-1/2" high
- Cast hi-rise spout
- Proximity® Sensing Technology
- Hands-free activation, entire spout is sensor
- Adjustable sensing range, auto shut-off, metering mode and periodic rinse feature
- Mixing valve required
- 3" max deck thickness
- Order 061159A for 4" or 061160A for 8" optional coverplates
- **Hardwire**, order AC filter and transformer separately
- **Battery operated**, batteries included
- **Plug-in**, power supply included
- **Less Power**, for use with plug-in power model for multiple faucet installation (1-PI plus 2 - 4 LP), ganging/splitter wire supplied on LP models



590TPA Trim ONLY for Recessed Box
(Must order rough-in number separately AND trim for complete product)

Model	Flow	Price	Finish
Hardwire Operated			
590TPA0128TR	1.5 gpm (5.7 L/min) (VRLAM)	344.75	Chrome
590TPA0158TR	0.5 gpm (1.9 L/min) (VRLAM)	344.75	Chrome
590TPA0198TR	0.35 gpm (1.3 L/min) (VRS)	344.75	Chrome

- 1-hole installation
- 5" long, 7-1/2" high
- Cast hi-rise spout
- Proximity® Sensing Technology
- Hands-free activation, entire spout is sensor
- Adjustable sensing range, auto shut-off, metering mode and periodic rinse feature
- 12" S/S cover, driver board, solenoid
- Requires separate order of rough-in for complete product
- Connection from box to spout not supplied
- 3" max deck thickness
- Order 061159A for 4" or 061160A for 8" optional coverplates
- **Hardwire**, order AC filter and transformer separately

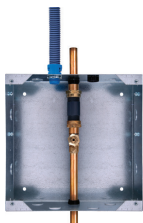

Rough-in ONLY – For Use with Trim
(Must order trim number separately AND rough-in for complete product)

Model	Flow	Price	Finish
ELAVT0001ARI	N/A	542.80	N/A

- Rough-in ONLY, NO mixing valve
- Recessed mount 10" x 10" box with single inlet supply
- Must order TRIM for complete model

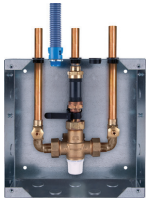

Rough-in ONLY – For Use with Trim
(Must order trim number separately AND rough-in for complete product)

Model	Flow	Price	Finish
ELAVT0008ARI	N/A	806.90	N/A

- Rough-in ONLY, with thermostatic mixing valve
- Recessed mount 10" x 10" box with thermostatic mixing valve
- Must order TRIM for complete model



Battery Backup for Surface Mount Box

Model	Flow	Price	Finish
063268A	N/A	71.25	N/A

- To convert installed hardwire or plug-in models
- One battery backup unit required for every spout/box
- Order separately



Battery Backup for Recessed Mount Box

Model	Flow	Price	Finish
063269A	N/A	71.25	N/A

- To convert installed hardwire models
- One battery backup unit required for every spout/box
- Order separately



AC Filter (063271A) plus 20 VA Transformer (060704A)

Model	Flow	Price	Finish
063267A	N/A	121.05	N/A

- Required for hardwire models
- Powers up to 5 units



3-Position Switch

Model	Flow	Price	Finish
060651A	N/A	249.45	N/A

- Refer to specification for applicable uses
- Order separately



Coverplate for Field Conversion

Model	Flow	Price	Finish
061159A	N/A	249.45	Chrome

- 4" (102 mm) coverplate



Coverplate for Field Conversion

Model	Flow	Price	Finish
061160A	N/A	109.60	Chrome

- 8" (203 mm) coverplate

See page C62 for available transformers.

MODEL NUMBER EXAMPLE:
Configurations vary, see below for availability.

591TF0228TR

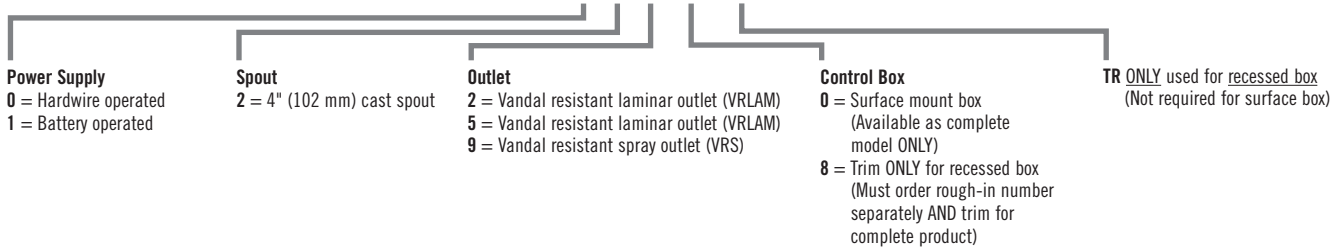

Surface Mount Box
(Available as complete models ONLY)

Model	Flow	Price	Finish
Hardwire Operated			
591TF0220	1.5 gpm (5.7 L/min) (VRLAM)	684.05	Chrome
591TF0250	0.5 gpm (1.9 L/min) (VRLAM)	684.05	Chrome
591TF0290	0.35 gpm (1.3 L/min) (VRS)	684.05	Chrome
Battery Operated			
591TF1220	1.5 gpm (5.7 L/min) (VRLAM)	684.05	Chrome
591TF1250	0.5 gpm (1.9 L/min) (VRLAM)	684.05	Chrome
591TF1290	0.35 gpm (1.3 L/min) (VRS)	684.05	Chrome

- 3-hole 4" installation
- 5" long, 5.3" high
- Hands-free activation
- Adjustable sensing range, auto shut-off, metering mode and periodic rinse feature
- Mixing valve required
- 2.5" max deck thickness
- Hardwire models, order transformer separately
- Battery operated, batteries included

Note: Available in Q4 2023



Trim ONLY for Recessed Box
(Must order rough-in number separately AND trim for complete product)

Model	Flow	Price	Finish
Hardwire Operated			
591TF0228TR	1.5 gpm (5.7 L/min) (VRLAM)	339.50	Chrome
591TF0258TR	0.5 gpm (1.9 L/min) (VRLAM)	339.50	Chrome
591TF0298TR	0.35 gpm (1.3 L/min) (VRS)	339.50	Chrome
Battery Operated			
591TF1228TR	1.5 gpm (5.7 L/min) (VRLAM)	339.50	Chrome
591TF1258TR	0.5 gpm (1.9 L/min) (VRLAM)	339.50	Chrome
591TF1298TR	0.35 gpm (1.3 L/min) (VRS)	339.50	Chrome

- 3-hole 4" installation
- 5" long, 5.3" high
- Hands-free activation
- Adjustable sensing range, auto shut-off, metering mode & periodic rinse feature
- 12" S/S cover, driver board, solenoid
- Requires separate order of rough-in for complete product
- Connection from box to spout not supplied
- 2.5" max deck thickness
- Hardwire models, order transformer separately
- Battery operated, batteries included

Note: Available in Q4 2023

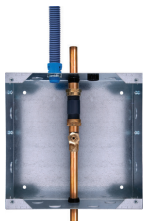

Rough-in ONLY – For Use with Trim
(Must order trim number separately AND rough-in for complete product)

Model	Flow	Price	Finish
ELAVT0001ARI	N/A	542.80	N/A

- Rough-in ONLY, NO mixing valve
- Recessed mount 10" x 10" box with single inlet supply
- Must order TRIM for complete model



Rough-in ONLY – For Use with Trim
(Must order trim number separately AND rough-in for complete product)

- Rough-in ONLY, with thermostatic mixing valve
- Recessed mount 10" x 10" box with thermostatic mixing valve
- Must order TRIM for complete model

Model	Flow	Price	Finish
ELAVT0008ARI	N/A	806.90	N/A



Hardwire Converter with Battery Backup

- Order separately

Model	Flow	Price	Finish
061047A	N/A	71.25	N/A



3-Position Switch

- Refer to specification for applicable uses
- Order separately

Model	Flow	Price	Finish
060651A	N/A	249.45	N/A

See page C62 for available transformers.

MODEL NUMBER EXAMPLE:
Configurations vary, see below for availability.

591TPA0220-PI-TR

TR ONLY used for recessed box
(Not required for surface box)

Power Supply
0 = Hardwire operated
1 = Battery operated
2 = Plug-in power

Spout
2 = 4" (102 mm) cast spout

Outlet
2 = Vandal resistant laminar
Agion® antimicrobial finish outlet (VRLAM)
5 = Vandal resistant laminar outlet (VRLAM)
9 = Vandal resistant spray outlet (VRS)

Control Box
0 = Surface mount box
(Available as complete model ONLY)
8 = Trim ONLY for recessed box
(Must order rough-in number AND trim, AC filter and transformer separately for complete product)

PI = Plug-in power supply
LP = Less power (Must order PI model separately)

591TPA Surface Mount Box (Available as complete models ONLY)



Model	Flow	Price	Finish
Hardwire Operated			
591TPA0220	1.5 gpm (5.7 L/min) (VRLAM)	665.85	Chrome
591TPA0250	0.5 gpm (1.9 L/min) (VRLAM)	665.85	Chrome
591TPA0290	0.35 gpm (1.3 L/min) (VRS)	665.85	Chrome
Battery Operated			
591TPA1220	1.5 gpm (5.7 L/min) (VRLAM)	708.85	Chrome
591TPA1250	0.5 gpm (1.9 L/min) (VRLAM)	708.85	Chrome
591TPA1290	0.35 gpm (1.3 L/min) (VRS)	708.85	Chrome
Plug-in Power			
591TPA2220-PI	1.5 gpm (5.7 L/min) (VRLAM)	708.85	Chrome
591TPA2250-PI	0.5 gpm (1.9 L/min) (VRLAM)	708.85	Chrome
591TPA2290-PI	0.35 gpm (1.3 L/min) (VRS)	708.85	Chrome
Less Power			
591TPA2220-LP	1.5 gpm (5.7 L/min) (VRLAM)	675.75	Chrome
591TPA2250-LP	0.5 gpm (1.9 L/min) (VRLAM)	675.75	Chrome
591TPA2290-LP	0.35 gpm (1.3 L/min) (VRS)	675.75	Chrome

- 3-hole, 4" installation
- 5" long, 5.8" high
- Cast body
- Proximity® Sensing Technology
- Hands-free activation, entire spout is sensor
- Adjustable sensing range, auto shut-off, metering mode and periodic rinse feature
- Mixing valve required
- 2.5" max. deck thickness
- **Hardwire**, order AC filter and transformer separately
- **Battery operated**, batteries included
- **Plug-in**, power supply included
- **Less Power**, for use with plug-in power model for multiple faucet installation (1-PI plus 2 - 4 LP), ganging/splitter wire supplied on LP models

591TPA Trim ONLY for Recessed Box (Must order rough-in number separately AND trim for complete product)



Model	Flow	Price	Finish
Hardwire Operated			
591TPA0228TR	1.5 gpm (5.7 L/min) (VRLAM)	334.15	Chrome
591TPA0258TR	0.5 gpm (1.9 L/min) (VRLAM)	334.15	Chrome
591TPA0298TR	0.35 gpm (1.3 L/min) (VRS)	334.15	Chrome

- 3-hole, 4" installation
- 5" long, 5.8" high
- Cast body
- Proximity® Sensing Technology
- Hands-free activation, entire spout is sensor
- Adjustable sensing range, auto shut-off, metering mode & periodic rinse feature
- 12" S/S cover, driver board, solenoid
- Requires separate order of rough-in for complete product
- Connection from box to spout not supplied
- 2.5" max. deck thickness
- **Hardwire**, order AC filter and transformer separately

Rough-in ONLY – For Use with Trim (Must order trim number separately AND rough-in for complete product)

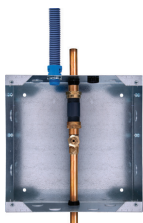

Model	Flow	Price	Finish
ELAVT0001ARI	N/A	542.80	N/A

- Rough-in ONLY, NO mixing valve
- Recessed mount 10" x 10" box with single inlet supply
- Must order TRIM for complete model

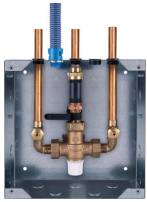

Rough-in ONLY – For Use with Trim
(Must order trim number separately AND rough-in for complete product)

Model	Flow	Price	Finish
ELAVT0008ARI	N/A	806.90	N/A

- Rough-in ONLY, with thermostatic mixing valve
- Recessed mount 10" x 10" box with thermostatic mixing valve
- Must order TRIM for complete model

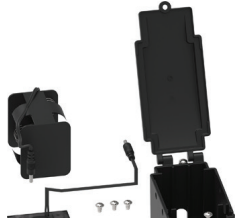

Battery Backup for Surface Mount Box

Model	Flow	Price	Finish
063268A	N/A	71.25	N/A

- To convert installed hardwire or plug-in models
- One battery backup unit required for every spout/box
- Order separately

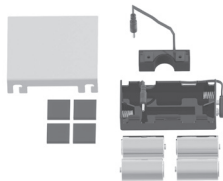

Battery Backup for Recessed Mount Box

Model	Flow	Price	Finish
063269A	N/A	71.25	N/A

- To convert installed hardwire models
- One battery backup unit required for every spout/box
- Order separately



AC Filter (063271A) plus 20 VA Transformer (060704A)

Model	Flow	Price	Finish
063267A	N/A	121.05	N/A

- Required for hardwire models
- Powers up to 5 units



3-Position Switch

Model	Flow	Price	Finish
060651A	N/A	249.45	N/A

- Refer to specification for applicable uses
- Order separately

See page C62 for available transformers.

MODEL NUMBER EXAMPLE:
Configurations vary, see below for availability.

620TPA3320-PI-TR-SS

Finish
SS = *Brilliance*® Stainless
BL = Matte Black
Blank = Chrome

Power Supply
0 = Hardwire operated
1 = Battery operated
2 = Plug-in power

Spout
3 = Gooseneck spout

Outlet
1 = Vandal resistant laminar outlet (VRLAM)
2 = Vandal resistant laminar outlet (VRLAM)
5 = Vandal resistant laminar outlet (VRLAM)
6 = Vandal resistant laminar outlet (VRLAM)

Control Box
0 = Surface mount box
(Available as complete model ONLY)
8 = Trim ONLY for recessed box
(Must order rough-in number AND trim, AC filter and transformer separately for complete product)

PI = Plug-in power supply
LP = Less power
(Must order PI model separately)

TR ONLY used for recessed box (not required for surface box)



620TPA Surface Mount Box
(Available as complete models ONLY)

Model	Flow	Price	Finish
Hardwire Operated			
620TPA3310	2.2 gpm (8.3 L/min) (VRLAM)	665.85	Chrome
620TPA3310-BL	2.2 gpm (8.3 L/min) (VRLAM)	745.20	Matte Black
620TPA3320	1.5 gpm (5.7 L/min) (VRLAM)	665.85	Chrome
620TPA3320-BL	1.5 gpm (5.7 L/min) (VRLAM)	745.20	Matte Black
620TPA3320-SS	1.5 gpm (5.7 L/min) (VRLAM)	745.20	<i>Brilliance</i> ® Stainless
620TPA3350	0.5 gpm (1.9 L/min) (VRLAM)	665.85	Chrome
620TPA3350-BL	0.5 gpm (1.9 L/min) (VRLAM)	745.20	Matte Black
620TPA3350-SS	0.5 gpm (1.9 L/min) (VRLAM)	745.20	<i>Brilliance</i> ® Stainless
620TPA3360-BL	1.0 gpm (3.8 L/min) (VRLAM)	745.20	Matte Black
Battery Operated			
621TPA3310-BL	2.2 gpm (8.3 L/min) (VRLAM)	788.60	Matte Black
621TPA3320	1.5 gpm (5.7 L/min) (VRLAM)	708.85	Chrome
621TPA3320-BL	1.5 gpm (5.7 L/min) (VRLAM)	788.60	Matte Black
621TPA3320-SS	1.5 gpm (5.7 L/min) (VRLAM)	788.60	<i>Brilliance</i> ® Stainless
621TPA3350	0.5 gpm (1.9 L/min) (VRLAM)	708.85	Chrome
621TPA3350-BL	0.5 gpm (1.9 L/min) (VRLAM)	788.60	Matte Black
621TPA3350-SS	0.5 gpm (1.9 L/min) (VRLAM)	788.60	<i>Brilliance</i> ® Stainless
621TPA3360	1.0 gpm (3.8 L/min) (VRLAM)	708.85	Chrome
621TPA3360-BL	1.0 gpm (3.8 L/min) (VRLAM)	788.60	Matte Black
Plug-in Power			
622TPA3320-PI	1.5 gpm (5.7 L/min) (VRLAM)	708.85	Chrome
622TPA3350-PI	0.5 gpm (1.9 L/min) (VRLAM)	708.85	Chrome
Less Power			
622TPA3320-LP	1.5 gpm (5.7 L/min) (VRLAM)	675.75	Chrome
622TPA3350-LP	0.5 gpm (1.9 L/min) (VRLAM)	675.75	Chrome

- 1-hole installation
- 4.8" long, 9.6" high
- Gooseneck spout
- Proximity® Sensing Technology
- Hands-free activation, entire spout is sensor
- Adjustable sensing range, auto shut-off, metering mode and periodic rinse feature
- Mixing valve required
- 2.5" max. deck thickness
- Order 061269A for 4" optional coverplate
- **Hardwire**, order AC filter and transformer separately
- **Battery operated**, batteries included
- **Plug-in**, power supply included
- **Less Power**, for use with plug-in power model for multiple faucet installation (1-PI plus 2 - 4 LP), ganging/splitter wire supplied on LP models



620TPA Trim ONLY for Recessed Box
(Must order rough-in number separately AND trim for complete product)

Model	Flow	Price	Finish
Hardwire Operated			
620TPA3318TR-SS	2.2 gpm (8.3 L/min) (VRLAM)	421.25	Brilliance® Stainless
620TPA3328TR	1.5 gpm (5.7 L/min) (VRLAM)	344.70	Chrome
620TPA3358TR	0.5 gpm (1.9 L/min) (VRLAM)	344.70	Chrome

- 1-hole installation
- 4.8" long, 9.6" high
- Gooseneck spout
- Proximity® Sensing Technology
- Hands-free activation, entire spout is sensor
- Adjustable sensing range, auto shut-off, metering mode and periodic rinse feature
- 12" S/S cover, driver board, solenoid
- Requires separate order of rough-in for complete product
- Connection from box to spout not supplied
- 2.5" max. deck thickness
- Order 061269A for 4" optional coverplate
- **Hardwire**, order AC filter and transformer separately

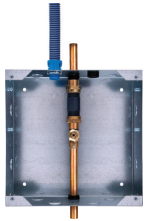

Rough-in ONLY – For Use with Trim
(Must order trim number separately AND rough-in for complete product)

Model	Flow	Price	Finish
ELAVT0001ARI	N/A	542.80	N/A

- Rough-in ONLY, NO mixing valve
- Recessed mount 10" x 10" box with single inlet supply
- Must order TRIM for complete model

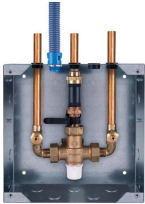

Rough-in ONLY – For Use with Trim
(Must order trim number separately AND rough-in for complete product)

Model	Flow	Price	Finish
ELAVT0008ARI	N/A	806.90	N/A

- Rough-in ONLY, with thermostatic mixing valve
- Recessed mount 10" x 10" box with thermostatic mixing valve
- Must order TRIM for complete model



Battery Backup for Surface Mount Box

Model	Flow	Price	Finish
063268A	N/A	71.25	N/A

- To convert installed hardwire or plug-in models
- One battery backup unit required for every spout/box
- Order separately



Battery Backup for Recessed Mount Box

Model	Flow	Price	Finish
063269A	N/A	71.25	N/A

- To convert installed hardwire models
- One battery backup unit required for every spout/box
- Order separately



AC Filter (063271A) plus 20 VA Transformer (060704A)

Model	Flow	Price	Finish
063267A	N/A	121.05	N/A

- Required for hardwire models
- Powers up to 5 units



3-Position Switch

- Refer to specification for applicable uses
- Order separately

Model	Flow	Price	Finish
060651A	N/A	249.45	N/A

Coverplate for Field Conversion

- 4" (102 mm) coverplate



Model	Flow	Price	Finish
061269A	N/A	85.90	Chrome
061269BL	N/A	104.00	Matte Black
061269SS	N/A	104.00	<i>Brilliance</i> ® Stainless

See page C62 for available transformers.

MODEL NUMBER EXAMPLE:
Configurations vary, see below for availability.

1500TF3 3 7 8 TR-R35

R* = Optional gooseneck spout dimensions:
R35 = 6" long, 11" high

Power Supply
0 = Hardwire operated
1 = Battery operated

Spout
3 = Single hole gooseneck

Outlet
1 = Smooth end, laminar outlet (VRLAM)
2 = Vandal resistant laminar outlet (VRLAM)
7 = Smooth end, laminar outlet (SELAM)
8 = Smooth end, laminar outlet (SELAM)

Control Box
0 = Surface mount box (Available as complete model ONLY)
8 = Trim ONLY for recessed box (Must order rough-in number separately AND trim for complete product)

TR ONLY used for recessed box (Not required for surface box)



Surface Mount Box
(Available as complete models ONLY)

Model	Flow	Price	Finish
Hardwire Operated – Smooth End Gooseneck			
1500TF3310	2.2 gpm (8.3 L/min) (SELAM)	783.00	Chrome
1500TF3310-R35	2.2 gpm (8.3 L/min) (SELAM)	789.65	Chrome
1500TF3370	1.5 gpm (5.7 L/min) (SELAM)	783.00	Chrome
1500TF3370-R35	1.5 gpm (5.7 L/min) (SELAM)	789.65	Chrome
1500TF3380	0.5 gpm (1.9 L/min) (SELAM)	783.00	Chrome
1500TF3380-R35	0.5 gpm (1.9 L/min) (SELAM)	789.65	Chrome

Hardwire Operated – Threaded Outlet			
1500TF3320	1.5 gpm (5.7 L/min) (VRLAM)	783.00	Chrome

Battery Operated – Smooth End Gooseneck			
1501TF3310	2.2 gpm (8.3 L/min) (SELAM)	783.00	Chrome
1501TF3370	1.5 gpm (5.7 L/min) (SELAM)	783.00	Chrome
1501TF3370-R35	1.5 gpm (5.7 L/min) (SELAM)	789.65	Chrome
1501TF3380	0.5 gpm (1.9 L/min) (SELAM)	783.00	Chrome
1501TF3380-R35	0.5 gpm (1.9 L/min) (SELAM)	789.65	Chrome

Battery Operated – Threaded Outlet			
1501TF3320	1.5 gpm (5.7 L/min) (VRLAM)	783.00	Chrome

Note: Available in Q4 2023

- 1-hole installation
- 6" long, 14.75" high
- Hands-free activation
- Adjustable sensing range, auto shut-off, metering mode and periodic rinse feature
- Mixing valve required
- 2.5" max deck thickness
- Order 060546A for 4" or 060547A for 8" optional coverplates
- Hardwire models, order transformer separately
- Battery operated, batteries included
- **R*** = Optional gooseneck spout dimensions:
R35 = 6" long, 11" high



Trim ONLY for Recessed Box
(Must order rough-in number separately AND trim for complete product)

Model	Flow	Price	Finish
Hardwire Operated – Threaded Outlet			
1500TF3328TR	1.5 gpm (5.7 L/min) (VRLAM)	394.55	Chrome
Battery Operated – Smooth End Gooseneck			
1501TF3378TR	1.5 gpm (5.7 L/min) (SELAM)	394.55	Chrome

Note: Available in Q4 2023

- 1-hole installation
- 6" long, 14.75" high
- Hands-free activation
- Adjustable sensing range, auto shut-off, metering mode and periodic rinse feature
- 12" S/S cover, driver board, solenoid
- Requires separate order of rough-in for complete product
- Connection from box to spout not supplied
- 2.5" max deck thickness
- Order 060546A for 4" or 060547A for 8" optional coverplates
- Hardwire models, order transformer separately
- Battery operated, batteries included
- **R*** = Optional gooseneck spout dimensions:
R35 = 6" long, 11" high

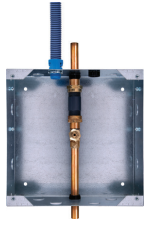

Rough-in ONLY – For Use with Trim
(Must order trim number separately AND rough-in for complete product)

Model	Flow	Price	Finish
ELAVT0001ARI	N/A	542.80	N/A

- Rough-in ONLY, NO mixing valve
- Recessed mount 10" x 10" box with single inlet supply
- Must order TRIM for complete model

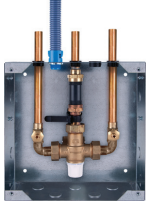

Rough-in ONLY – For Use with Trim
(Must order trim number separately AND rough-in for complete product)

Model	Flow	Price	Finish
ELAVT0008ARI	N/A	806.90	N/A

- Rough-in ONLY, with thermostatic mixing valve
- Recessed mount 10" x 10" box with thermostatic mixing valve
- Must order TRIM for complete model



Hardwire Converter with Battery Backup

Model	Flow	Price	Finish
061047A	N/A	71.25	N/A

- Order separately



3-Position Switch

Model	Flow	Price	Finish
060651A	N/A	249.45	N/A

- Refer to specification for applicable uses
- Order separately



Coverplate for Field Conversion

Model	Flow	Price	Finish
060546A	N/A	85.35	Chrome

- 4" (102 mm) coverplate



Coverplate for Field Conversion

Model	Flow	Price	Finish
060547A	N/A	109.65	Chrome

- 8" (204 mm) coverplate

See page C62 for available transformers.

MODEL NUMBER EXAMPLE:
Configurations vary, see below for availability.

1500TF4670-R35

R* = Optional gooseneck
spout dimensions:
R35 = 6" long, 12" high

Power Supply
0 = Hardwire operated
1 = Battery operated

Spout
6 = Wallmount gooseneck

Outlet
1 = Smooth end, laminar outlet (SELAM)
2 = Vandal resistant laminar outlet (VRLAM)
7 = Smooth end, laminar outlet (SELAM)

Control Box
0 = Surface mount box (Available as complete model ONLY)
8 = Recessed box (Available as complete model ONLY)



Electronic Wallmount Faucet with Surface Mount Box
(Available as complete models ONLY)

Model	Flow	Price	Finish
Hardwire Operated – Smooth End Gooseneck			
1500TF4610	2.2 gpm (8.3 L/min) (SELAM)	848.25	Chrome
1500TF4670	1.5 gpm (5.7 L/min) (SELAM)	854.95	Chrome
1500TF4670-R35	1.5 gpm (5.7 L/min) (SELAM)	854.95	Chrome
Hardwire Operated – Threaded Outlet			
1500TF4620	1.5 gpm (5.7 L/min) (VRLAM)	848.25	Chrome
Battery Operated – Smooth End Gooseneck			
1501TF4670	1.5 gpm (5.7 L/min) (SELAM)	848.25	Chrome
Battery Operated – Threaded Outlet			
1501TF4620	1.5 gpm (5.7 L/min) (VRLAM)	848.25	Chrome

- Wallmount installation
- 6" long, 15.75" high
- Hands-free activation
- Adjustable sensing range, auto shut-off, metering mode and periodic rinse feature
- Mixing valve required
- Hardwire models, order transformer separately
- Battery operated, batteries included

Note: Available in Q4 2023



Electronic Wallmount Faucet with Recessed Box
(Available as complete models ONLY)

Model	Flow	Price	Finish
WITH Thermostatic Mixing Valve			
Hardwire Operated – Smooth End Gooseneck			
1500TF4678	1.5 gpm (5.7 L/min) (SELAM)	1,228.90	Chrome
Hardwire Operated – Threaded Outlet			
1500TF4628	1.5 gpm (5.7 L/min) (VRLAM)	1,228.90	Chrome

- Wallmount installation
- 6" long, 15.75" high
- Hands-free activation
- Adjustable sensing range, auto shut-off, metering mode and periodic rinse feature
- 12" S/S cover, driver board, solenoid
- Connection from box to spout not supplied
- Hardwire models, order transformer separately
- Battery operated, batteries included

Note: Available in Q4 2023



Hardwire Converter with Battery Backup

Model	Flow	Price	Finish
061047A	N/A	71.25	N/A

- Order separately



3-Position Switch

Model	Flow	Price	Finish
060651A	N/A	249.45	N/A

- Refer to specification for applicable uses
- Order separately

See page C62 for available transformers.

MODEL NUMBER EXAMPLE:
Configurations vary, see below for availability.

860T 1 6 8

Power Supply
0 = Hardwire operated
1 = Battery operated

Shower
0 = No shower head
5 = Hand shower w/24" SS grab bar and ADA slide
6 = 30° VR wallmount shower head
7 = 30° VR forged wallmount shower head

Control Box
3 = 8" Recessed box, no mixing valve
6 = Components only UNASSEMBLED, 4" box, no mixing valve
7 = 10" Recessed box, pressure balance mixing valve
8 = 10" Recessed box, thermostatic mixing valve

860T Electronic Shower with 8" Recessed Box – No Mixing Valve



Model	Flow	Price	Finish
Hardwire Operated			
860T103	N/A	874.60	Chrome

- Recessed metal box
- No mixing valve
- Electronic shower with push button activator
- NO shower head
- Field adjustable shower time
- Hardwire models, order transformer separately
- Battery operated, batteries included

860T Electronic Shower with 4" Recessed Box – Components Only UNASSEMBLED – No Mixing Valve



Model	Flow	Price	Finish
Hardwire Operated			
860T106	N/A	540.35	Chrome
Battery Operated			
861T106	N/A	540.35	Chrome

- Recessed metal box
- Components unassembled
- No mixing valve
- Electronic shower with push button activator
- NO shower head
- Field adjustable shower time
- Hardwire models, order transformer separately
- Battery operated, batteries included

860T Electronic Shower with 10" Recessed Box – Pressure Balance Mixing Valve



Model	Flow	Price	Finish
Hardwire Operated			
860T107	N/A	1,325.95	Chrome
Battery Operated			
861T107	N/A	1,325.95	Chrome

- Recessed metal box
- Pressure balance mixing valve
- Electronic shower with push button activator
- NO shower head
- Vandal resistant handle adjusts temperature
- Red/blue indicator
- Field adjustable shower time
- Hardwire models, order transformer separately
- Battery operated, batteries included

860T Electronic Shower with Hand Shower and 10" Recessed Box – Pressure Balance Mixing Valve



Model	Flow	Price	Finish
Hardwire Operated			
860T157	1.5 gpm (5.7 L/min)	1,636.45	Chrome

- Recessed metal box
- Pressure balance mixing valve
- Electronic shower with push button activator
- 24" long, 1 1/2" stainless slide/grab bar
- ADA adjustable mount
- Hand shower and 70" vinyl hose
- ADA-compliant grab bar (when installed per accessibility guidelines of the act)
- Touch-Clean® 2-setting hand shower is WaterSense® labeled
- Pause, Full Body Spray
- Vandal resistant handle adjusts temperature
- Red/blue indicator
- Field adjustable shower time
- Hardwire models, order transformer separately
- Battery operated, batteries included

#7 control box with pressure balance valve rated at minimum 1.2 gpm (4.5 L/min) @ 45 psi (310 kPa).

#8 control box with thermostatic valve rated at minimum 0.35 gpm (1.3 L/min) @ 45 psi (310 kPa).

Stated flow rate for shower heads at 80 psi maximum water usage.

DELTA COMMERCIAL TECHNICAL SERVICE 1-877-509-2680
ONLINE CATALOG: deltafaucet.com (Complete Product Offering & Part Numbering System)



860T Electronic Shower with 30° Wallmount Shower Head and 10" Recessed Box – Pressure Balance Mixing Valve

Model	Flow	Price	Finish
Hardwire Operated			
860T167	1.5 gpm (5.7 L/min)	1,563.10	Chrome
Battery Operated			
861T167	1.5 gpm (5.7 L/min)	1,563.10	Chrome

- Recessed metal box
- Pressure balance mixing valve
- Electronic shower with push button activator
- 30° vandal resistant cast wallmount shower head
- Vandal resistant handle adjusts temperature
- Red/blue indicator
- Field adjustable shower time
- Hardwire models, order transformer separately
- Battery operated, batteries included



860T Electronic Shower with 30° Wallmount Shower Head and 10" Recessed Box – Pressure Balance Mixing Valve

Model	Flow	Price	Finish
Hardwire Operated			
860T177	1.5 gpm (5.7 L/min)	1,563.10	Chrome
Battery Operated			
861T177	1.5 gpm (5.7 L/min)	1,563.10	Chrome

- Recessed metal box
- Pressure balance mixing valve
- Electronic shower with push button activator
- 30° vandal resistant forged wallmount shower head is WaterSense® labeled
- Vandal resistant handle adjusts temperature
- Red/blue indicator
- Field adjustable shower time
- Hardwire models, order transformer separately
- Battery operated, batteries included



860T Electronic Shower with 10" Recessed Box – Thermostatic Mixing Valve

Model	Flow	Price	Finish
Hardwire Operated			
860T108	N/A	1,325.95	Chrome
Battery Operated			
861T108	N/A	1,325.95	Chrome

- Recessed metal box
- Thermostatic mixing valve
- Electronic shower with push button activator
- NO shower head
- Tempered water supplied to solenoid valve
- Field adjustable shower time
- Hardwire models, order transformer separately
- Battery operated, batteries included



860T Electronic Shower with Hand Shower and 10" Recessed Box – Thermostatic Mixing Valve

Model	Flow	Price	Finish
Hardwire Operated			
860T158	1.5 gpm (5.7 L/min)	1,565.95	Chrome

- Recessed metal box
- Thermostatic mixing valve
- Electronic shower with push button activator
- 24" long, 1 1/2" stainless slide/grab bar
- ADA adjustable mount
- Hand shower and 70" vinyl hose
- ADA-compliant grab bar (when installed per accessibility guidelines of the act)
- Touch-Clean® 2-setting hand shower is WaterSense® labeled
- Pause, Full Body Spray
- Tempered water supplied to solenoid valve
- Field adjustable shower time
- Hardwire models, order transformer separately
- Battery operated, batteries included



860T Electronic Shower with 30° Wallmount Shower Head and 10" Recessed Box – Thermostatic Mixing Valve

Model	Flow	Price	Finish
Hardwire Operated			
860T168	1.5 gpm (5.7 L/min)	1,563.10	Chrome

- Recessed metal box
- Thermostatic mixing valve
- Electronic shower with push button activator
- 30° vandal resistant cast wallmount shower head
- Tempered water supplied to solenoid valve
- Field adjustable shower time
- Hardwire models, order transformer separately
- Battery operated, batteries included

#7 control box with pressure balance valve rated at minimum 1.2 gpm (4.5 L/min) @ 45 psi (310 kPa).
 #8 control box with thermostatic valve rated at minimum 0.35 gpm (1.3 L/min) @ 45 psi (310 kPa).
 Stated flow rate for shower heads at 80 psi maximum water usage.



860T Electronic Shower with 30° Wallmount Shower Head and 10" Recessed Box – Thermostatic Mixing Valve

Model	Flow	Price	Finish
Hardwire Operated			
860T178	1.5 gpm (5.7 L/min)	1,563.10	Chrome

- Recessed metal box
- Thermostatic mixing valve
- Electronic shower with push button activator
- 30° vandal resistant forged wallmount shower head is WaterSense® labeled
- Tempered water supplied to solenoid valve
- Field adjustable shower time
- Hardwire models, order transformer separately
- Battery operated, batteries included



Hardwire Converter with Battery Backup

Model	Flow	Price	Finish
061047A	N/A	71.25	N/A

- Order separately

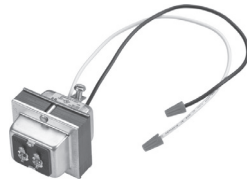

20 VA Transformer

Model	Flow	Price	Finish
060704A	N/A	76.10	N/A

- Supplies power for:
Up to 10 - 590-HDF electronic faucets converted to hardwire, OR
Up to 10 - 860T push-button electronic showers, OR
Up to 5 - 3000T, 1500T, 590T, 590TP, 591T, 591TP, DEMD, 600T, 620TP or 630TP series electronic faucets, OR
Up to 5 - 1600T, 81THWA or 81TWMS series electronic flush valves



40 VA Transformer

Model	Flow	Price	Finish
060771A	N/A	77.45	N/A

- Supplies power for:
Up to 10 - 3000T, 1500T, 590T, 590TP, 591T, 591TP, DEMD, 600T, 620TP or 630TP series electronic faucets, OR
Up to 10 - 1600T, 81THWA or 81TWMS series electronic flush valves



Plug-In Transformer

Model	Flow	Price	Finish
RP32856	N/A	60.75	N/A

- Supplies power for:
Up to 10 - 590-HDF electronic faucets converted to hardwire, OR
Up to 10 - 860T push-button electronic showers, OR
Up to 5 - 3000T, 1500T, 590T, 590TP, 591T, 591TP, DEMD, 600T, 620TP or 630TP series electronic faucets, OR
Up to 5 - 1600T, 81THWA or 81TWMS series electronic flush valves

#7 control box with pressure balance valve rated at minimum 1.2 gpm (4.5 L/min) @ 45 psi (310 kPa).

#8 control box with thermostatic valve rated at minimum 0.35 gpm (1.3 L/min) @ 45 psi (310 kPa).

Stated flow rate for shower heads at 80 psi maximum water usage.

DELTA COMMERCIAL TECHNICAL SERVICE 1-877-509-2680
ONLINE CATALOG: deltafaucet.com (Complete Product Offering & Part Numbering System)



Flush Valves

MODEL NUMBER EXAMPLE:
Configurations vary, see below for availability.

81T201-548

Valve

- 0 = Water closet, 11 1/2" height, top spud
- 2 = Water closet, 24" height, top spud
- 3 = Urinal
- 6 = Water closet, 24" height, offset top spud
- 7 = Water closet, 15" height, back spud

Options

- 1 = Trap seal primer or detergent/disinfectant tee
- 5 = Center cover bumper
- 30 = Less stop, with modified tail to fit Sloan/Zurn® stop

Flush Volume

- 48 = 1.27 gpf (4.8 Lpf) fixed
- 42 = 1.1 gpf (4.2 Lpf) fixed
- 19 = 0.5 gpf (1.9 Lpf) fixed
- 05 = 0.125 gpf (0.5 Lpf) fixed
- Blank = Adjustable

Flush Valves



81T Manual Water Closet Exposed Flush Valve – 11-1/2" Height, Top Spud

Model		Flow	Price	Finish
81T201		1.6 gpf (6 Lpf) (ADJ)	213.35	Chrome
81T201-1		1.6 gpf (6 Lpf) (ADJ)	280.05	Chrome
81T201-30		1.6 gpf (6 Lpf) (ADJ)	194.90	Chrome
81T201-42		1.1 gpf (4.2 Lpf) (FXD)	213.35	Chrome
81T201-48		1.27 gpf (4.8 Lpf) (FXD)	213.35	Chrome
81T201-5		1.6 gpf (6 Lpf) (ADJ)	229.70	Chrome
81T201-542		1.1 gpf (4.2 Lpf) (FXD)	229.70	Chrome
81T201-548		1.27 gpf (4.8 Lpf) (FXD)	229.70	Chrome

- Manual exposed flush valve
- ADA lever handle
- Vacuum breaker
- 1" inlet
- For 1-1/2" spud water closet fixture
- ADJ = field adjustable
- FXD = fixed flow
- **Options/Add-Ons:**
 - 1 = Trap seal primer or detergent/disinfectant tee
 - 5 = Center bumper on valve
 - 30 = Less stop, with modified tail to fit Sloan/Zurn® stop



81T Manual Water Closet Exposed Flush Valve – 24" Height, Top Spud

Model		Flow	Price	Finish
81T221		1.6 gpf (6 Lpf) (ADJ)	245.95	Chrome
81T221-48		1.27 gpf (4.8 Lpf) (FXD)	245.95	Chrome

- Manual exposed flush valve
- ADA lever handle
- Vacuum breaker
- 1" inlet
- For 1-1/2" spud water closet fixture
- ADJ = field adjustable
- FXD = fixed flow



81T Manual Water Closet Exposed Flush Valve – 24" Height, Offset Tube, Top Spud

Model		Flow	Price	Finish
81T261		1.6 gpf (6 Lpf) (ADJ)	336.35	Chrome

- Manual exposed flush valve
- ADA lever handle
- Vacuum breaker
- 1" inlet
- For 1-1/2" spud water closet fixture
- ADJ = field adjustable
- FXD = fixed flow



81T Manual Water Closet Exposed Flush Valve – 15" Height, Back Spud

Model		Flow	Price	Finish
81T271		1.6 gpf (6 Lpf) (ADJ)	254.85	Chrome

- Manual exposed flush valve
- ADA lever handle
- Vacuum breaker
- 1" inlet
- For 1-1/2" spud water closet fixture
- ADJ = field adjustable
- FXD = fixed flow

-42 models recommended for new construction only.

Sloan® is a registered trademark of the Sloan Valve Company. Zurn® is a registered trademark of Zurn Industries, LLC.



81T Manual Urinal Exposed Flush Valve – 13" Height, Top Spud

Model		Flow	Price	Finish
81T231		0.5 gpf (1.9 Lpf) (ADJ)	213.35	Chrome
81T231-05		0.125 gpf (0.5 Lpf) (FXD)	213.35	Chrome
81T231-19		0.5 gpf (1.9 Lpf) (FXD)	213.35	Chrome
81T231-30		0.5 gpf (1.9 Lpf) (ADJ)	194.90	Chrome

- Manual exposed flush valve
- ADA lever handle
- Vacuum breaker
- 3/4" copper sweat inlet
- for 3/4" spud urinal fixture
- ADJ = field adjustable
- FXD = fixed flow
- **Options/Add-Ons:**
 - 30 = Less stop, with modified tail to fit Sloan®/Zurn® stop



Adjustable Split Ring Hanger – 3/4" Diameter

- 3/4" dia. brass adjustable split ring hanger

Model		Flow	Price	Finish
060115A		N/A	78.10	Chrome



Adjustable Split Ring Hanger – 1 1/2" Diameter

- 1-1/2" dia. brass adjustable split ring hanger

Model		Flow	Price	Finish
060117A		N/A	94.55	Chrome

Sloan® is a registered trademark of the Sloan Valve Company. Zurn® is a registered trademark of Zurn Industries, LLC.

MODEL NUMBER EXAMPLE:
Configurations vary, see below for availability.

83T 1 4 0 - 48

Fixture Type

- 0 = 1 1/2" FIP back spud
- 1 = 1 1/2" wall hung back inlet
- 2 = 1 1/2" freestanding back inlet
- 3 = 1 1/2" top inlet
- 4 = 3/4" back spud

Valve

- 0 = Prison
- 3 = Urinal
- 4 = Water closet

Handle

- 0 = 5/8" push button
- 1 = ADA oscillating handle

Flush Volume

- 48 = 1.27 gpf (4.8 Lpf) fixed
- Blank = Adjustable

Flush Valves



83T Manual Water Closet Concealed Flush Valve with Push Button – F.I.P. Penal Back Spud

Model	Flow	Price	Finish
83T000	1.6 gpf (6 Lpf) (ADJ)	362.80	Chrome

- Manual concealed flush valve
- 5/8" vandal resistant push button
- Vacuum breaker
- 1" inlet
- For 1-1/2" prison water closet fixture
- ADJ = field adjustable
- FXD = fixed flow



83T Manual Water Closet Concealed Flush Valve with Push Button – Wall Hung Back Spud

Model	Flow	Price	Finish
83T140	1.6 gpf (6 Lpf) (ADJ)	341.30	Chrome

- Manual concealed flush valve
- 5/8" vandal resistant push button
- Vacuum breaker
- 1" inlet
- For 1-1/2" spud water closet fixture
- ADJ = field adjustable
- FXD = fixed flow



83T Manual Water Closet Concealed Flush Valve with Push Button – Free Standing Back Spud

Model	Flow	Price	Finish
83T240	1.6 gpf (6 Lpf) (ADJ)	376.10	Chrome

- Manual concealed flush valve
- 5/8" vandal resistant push button
- Vacuum breaker
- 1" inlet
- For 1-1/2" spud water closet fixture
- ADJ = field adjustable
- FXD = fixed flow



83T Manual Water Closet Concealed Flush Valve with ADA Handle – Wall Hung Back Spud

Model	Flow	Price	Finish
83T141	1.6 gpf (6 Lpf) (ADJ)	360.40	Chrome

- Manual concealed flush valve
- ADA oscillating handle
- Vacuum breaker
- 1" inlet
- For 1-1/2" spud water closet fixture
- ADJ = field adjustable
- FXD = fixed flow



83T Manual Water Closet Concealed Flush Valve with ADA Handle – Free Standing Back Spud

Model	Flow	Price	Finish
83T241 	1.6 gpf (6 Lpf) (ADJ)	388.00	Chrome

- Manual concealed flush valve
- ADA oscillating handle
- Vacuum breaker
- 1" inlet
- For 1-1/2" spud water closet fixture
- ADJ = field adjustable
- FXD = fixed flow



83T Manual Water Closet Concealed Flush Valve with ADA Handle – Top Spud

Model	Flow	Price	Finish
83T341 	1.6 gpf (6 Lpf) (ADJ)	418.55	Chrome

- Manual concealed flush valve
- ADA oscillating handle
- Vacuum breaker
- 1" inlet
- For 1-1/2" spud water closet fixture
- ADJ = field adjustable
- FXD = fixed flow



83T Manual Urinal Concealed Flush Valve with Push Button – Back Spud

Model	Flow	Price	Finish
83T430	0.5 gpf (1.9 Lpf) (ADJ)	383.60	Chrome

- Manual concealed flush valve
- Back spud
- 5/8" vandal resistant push button
- Vacuum breaker
- 3/4" inlet
- For 3/4" spud urinal fixture
- ADJ = field adjustable
- FXD = fixed flow



83T Manual Urinal Concealed Flush Valve with ADA Handle – Back Spud

Model	Flow	Price	Finish
83T431 	0.5 gpf (1.9 Lpf) (ADJ)	376.10	Chrome

- Manual concealed flush valve
- Back spud
- ADA oscillating handle
- Vacuum breaker
- 3/4" inlet
- For 3/4" spud urinal fixture
- ADJ = field adjustable
- FXD = fixed flow



Accessories

Model	Flow	Price	Finish
9T400	N/A	190.35	Stainless Steel

- 12" x 12" access frame with 14" x 14" Stainless Steel cover

MODEL NUMBER EXAMPLE:

Configurations vary, see below for availability.

81T201SP-48-MMO

Valve

0 = Water closet, 11-1/2" height
3 = Urinal, 13" height

SP = Solar

Flush Volume

48 = 1.27 gpf (4.8 Lpf) fixed
42 = 1.1 gpf (4.2 Lpf) fixed
19 = 0.5 gpf (1.9 Lpf) fixed
05 = 0.125 gpf (0.5 Lpf) fixed
Blank = Adjustable

Options

DF = Dual flush
MMO = Mechanical manual override

81T Solar Electronic Water Closet Flush Valve – 11-1/2" Height



Model	Flow	Price	Finish
81T201SP-42-MMO	1.1 gpf (4.2 Lpf) (FXD)	831.15	Chrome
81T201SP-48-MMO	1.27 gpf (4.8 Lpf) (FXD)	831.15	Chrome
81T201SP-DF-MMO	1.6 gpf (6 Lpf) (ADJ)	831.15	Chrome
81T201SP-MMO	1.6 gpf (6 Lpf) (ADJ)	831.15	Chrome

- Solar electronic exposed flush valve
- Hands-free operation
- Top mounted electronic sensor and solar module
- Vacuum breaker
- 1" inlet
- For 1-1/2" top spud water closet fixture
- Batteries required and included
- ADJ = field adjustable
- FXD = fixed flow
- **Options/Add-Ons:**
DF = Dual flush set to ON, full flush or 30% reduced flush
MMO = Mechanical manual override

81T Solar Electronic Urinal Flush Valve – 13" Height



Model	Flow	Price	Finish
81T231SP-05-MMO	0.125 gpf (0.5 Lpf) (FXD)	831.15	Chrome
81T231SP-19-MMO	0.5 gpf (1.9 Lpf) (FXD)	831.15	Chrome
81T231SP-MMO	0.5 gpf (1.9 Lpf) (ADJ)	831.15	Chrome

- Solar electronic exposed flush valve
- Hands-free operation
- Top mounted electronic sensor and solar module
- Vacuum breaker
- 3/4" copper sweat inlet
- For 3/4" top spud urinal fixture
- Batteries required and included
- ADJ = field adjustable
- FXD = fixed flow
- **Options/Add-Ons:**
MMO = Mechanical manual override

-42 models recommended for new construction ONLY.

MODEL NUMBER EXAMPLE:
Configurations vary, see below for availability.

81T201BTA-48-MMO-BL

Finish
BL = Matte Black w/Chrome
Blank = Chrome

Valve

- 0 = Water closet, 11 1/2" height
- 2 = Water closet, 24" height
- 3 = Urinal, 13" height

Power

- BT = Battery operated
- HW = Hardwire operated

Options

- 20 = Less stop
- 30 = Less stop, with modified tail to fit Sloan®/Zurn® stop
- DF = Dual flush
- MMO = Mechanical manual override

Flush Volume

- 48 = 1.27 gpf (4.8 Lpf) fixed
- 42 = 1.1 gpf (4.2 Lpf) fixed
- 19 = 0.5 gpf (1.9 Lpf) fixed
- 05 = 0.125 gpf (0.5 Lpf) fixed
- Blank = Adjustable



81T H₂Optics® Sensing Technology Electronic Water Closet Flush Valve – 11 1/2" Height

Model	Flow	Price	Finish
Battery Operated			
81T201BTA	1.6 gpf (6 Lpf) (ADJ)	687.55	Chrome
81T201BTA-20	1.6 gpf (6 Lpf) (ADJ)	654.85	Chrome
81T201BTA-30-MMO	1.6 gpf (6 Lpf) (ADJ)	654.85	Chrome
81T201BTA-42-MMO	1.1 gpf (4.2 Lpf) (FXD)	687.55	Chrome
81T201BTA-42-MMO-BL	1.1 gpf (4.2 Lpf) (FXD)	796.20	Matte Black w/Chrome
81T201BTA-48	1.27 gpf (4.8 Lpf) (FXD)	687.55	Chrome
81T201BTA-48-MMO	1.27 gpf (4.8 Lpf) (FXD)	687.55	Chrome
81T201BTA-48-MMO-BL	1.27 gpf (4.8 Lpf) (FXD)	716.00	Matte Black w/Chrome
81T201BTA-DF	1.6 gpf (6 Lpf) (ADJ)	687.55	Chrome
81T201BTA-MMO	1.6 gpf (6 Lpf) (ADJ)	687.55	Chrome
81T201BTA-MMO-BL	1.6 gpf (6 Lpf) (ADJ)	796.20	Matte Black w/Chrome
81T201BTA-30-48-MMO	1.6 gpf (6 Lpf) (ADJ)	913.68	Chrome
Hardwire Operated			
81T201HWA	1.6 gpf (6 Lpf) (ADJ)	747.25	Chrome
81T201HWA-42-MMO	1.1 gpf (4.2 Lpf) (FXD)	747.25	Chrome
81T201HWA-42-MMO-BL	1.1 gpf (4.2 Lpf) (FXD)	865.50	Matte Black w/Chrome
81T201HWA-48	1.27 gpf (4.8 Lpf) (FXD)	747.25	Chrome
81T201HWA-48-MMO-BL	1.27 gpf (4.8 Lpf) (FXD)	865.50	Matte Black w/Chrome
81T201HWA-DF	1.6 gpf (6 Lpf) (ADJ)	747.25	Chrome
81T201HWA-MMO-BL	1.6 gpf (6 Lpf) (ADJ)	865.50	Matte Black w/Chrome

- Electronic exposed flush valve
- Hands-free operation
- Body mounted sensor
- Vacuum breaker
- 1" inlet
- For 1-1/2" top spud water closet fixture
- Hardwire models, order transformer separately
- Battery operated, batteries included
- ADJ = field adjustable
- FXD = fixed flow
- **Options/Add-Ons:**
 - 20 = Less stop
 - 30 = Less stop, with modified tail to fit Sloan®/Zurn® stop
 - DF = Dual flush set to ON, full flush or 30% reduced flush
 - MMO = Mechanical manual override

Flush Valves



81T H₂Optics® Sensing Technology Electronic Water Closet Flush Valve – 24" Height

Model	Flow	Price	Finish
Battery Operated			
81T221BTA-48	1.27 gpf (4.8 Lpf) (FXD)	674.70	Chrome
Hardwire Operated			
81T221HWA-48	1.27 gpf (4.8 Lpf) (FXD)	731.90	Chrome
81T221HWA-DF	1.6 gpf (6 Lpf) (ADJ)	731.90	Chrome

- Electronic exposed flush valve
- Hands-free operation
- Body mounted sensor
- Vacuum breaker
- 1" inlet
- For 1-1/2" top spud water closet fixture
- Hardwire models, order transformer separately
- Battery operated, batteries included
- ADJ = field adjustable
- FXD = fixed flow
- **Options/Add-Ons:**
 - DF = Dual flush set to ON, full flush or 30% reduced flush

-42 models recommended for new construction ONLY.

Sloan® is a registered trademark of the Sloan Valve Company. Zurn® is a registered trademark of Zurn Industries, LLC.



81T H₂Optics® Sensing Technology Electronic Urinal Flush Valve – 13" Height

Model	Flow	Price	Finish
Battery Operated			
81T231BTA	0.5 gpf (1.9 Lpf) (ADJ)	687.55	Chrome
81T231BTA-05	0.125 gpf (0.5 Lpf) (FXD)	796.20	Chrome
81T231BTA-05-MMO	0.125 gpf (0.5 Lpf) (FXD)	687.55	Chrome
81T231BTA-05-MMO-BL	0.125 gpf (0.5 Lpf) (FXD)	796.20	Matte Black w/Chrome
81T231BTA-19	0.5 gpf (1.9 Lpf) (FXD)	687.55	Chrome
81T231BTA-20	0.5 gpf (1.9 Lpf) (ADJ)	654.85	Chrome
81T231BTA-30-MMO	0.5 gpf (1.9 Lpf) (ADJ)	654.85	Chrome
81T231BTA-MMO	0.5 gpf (1.9 Lpf) (ADJ)	687.55	Chrome
81T231BTA-MMO-BL	0.5 gpf (1.9 Lpf) (ADJ)	796.20	Matte Black w/Chrome
Hardwire Operated			
81T231HWA	0.5 gpf (1.9 Lpf) (ADJ)	747.25	Chrome
81T231HWA-05	0.125 gpf (0.5 Lpf) (FXD)	865.50	Chrome
81T231HWA-05-MMO-BL	0.125 gpf (0.5 Lpf) (FXD)	865.50	Matte Black w/Chrome
81T231HWA-MMO-BL	0.5 gpf (1.9 Lpf) (ADJ)	865.50	Matte Black w/Chrome

- Electronic exposed flush valve
- Hands-free operation
- Body mounted sensor
- Vacuum breaker
- 3/4" copper sweat inlet
- For 3/4" top spud urinal fixture
- Hardwire models, order transformer separately
- Battery operated, batteries included
- ADJ = field adjustable
- FXD = fixed flow
- **Options/Add-Ons:**
 20 = Less stop
 30 = Less stop, with modified tail to fit Sloan/Zurn® stop
 MMO = Mechanical manual override

Flush Valves



Hardwire Converter with Battery Backup

• Order separately

Model	Flow	Price	Finish
061047A	N/A	71.25	N/A

-42 models recommended for new construction ONLY.

Sloan® is a registered trademark of the Sloan Valve Company. Zurn® is a registered trademark of Zurn Industries, LLC. See page C62 for available transformers.

MODEL NUMBER EXAMPLE:
Configurations vary, see below for availability.



81T201 - 48 - WMSHWA

Valve
0 = Water closet
3 = Urinal

Flush Volume
48 = 1.27 gpf (4.8 Lpf) fixed
42 = 1.1 gpf (4.2 Lpf) fixed
19 = 0.5 gpf (1.9 Lpf) fixed
05 = 0.125 gpf (0.5 Lpf) fixed
Blank = Adjustable



81T H₂Optics® Sensing Technology Electronic Water Closet Flush Valve – 11 1/2" Height

Model	Flow	Price	Finish
81T201-48-WMSHWA  	1.27 gpf (4.8 Lpf) (FXD)	890.15	Chrome
81T201-WMSHWA 	1.6 gpf (6 Lpf) (ADJ)	930.25	Chrome

- Electronic exposed flush valve
- Hands-free operation
- 11 1/2" high
- 4" wallmount sensor
- Vacuum breaker
- 1" inlet
- For 1-1/2" top spud water closet fixture
- Hardwire operated, order transformer separately
- ADJ = field adjustable
- FXD = fixed flow



81T H₂Optics® Sensing Technology Electronic Urinal Flush Valve – 13" Height

Model	Flow	Price	Finish
81T231-WMSHWA 	0.5 gpf (1.9 Lpf) (ADJ)	930.25	Chrome

- Electronic exposed flush valve
- Hands-free operation
- 4" wallmount sensor
- 13" high
- Vacuum breaker
- 3/4" copper sweat inlet
- For 3/4" top spud urinal fixture
- Hardwire operated, order transformer separately
- ADJ = field adjustable
- FXD = fixed flow



Hardwire Converter with Battery Backup

Model	Flow	Price	Finish
061047A	N/A	71.25	N/A

- Order separately

-42 models recommended for new construction ONLY.
See page C62 for available transformers.

MODEL NUMBER EXAMPLE:

Configurations vary, see below for availability.

1600T6 1 0 2 ATR - 42

Fixture Type

- 1 = Wall hung water closet, back inlet
- 2 = Freestanding water closet, back inlet
- 3 = Water closet, top inlet
- 4 = Urinal, back inlet, syphon jet

Control Box

- 2 = 12" x 18" frame w/cover
- 3 = 12" frame w/cover
- 4 = 4" box

Trim/Rough-In

- TR** = Trim (requires separate order of rough-in with same flow for complete product)
- RI** = Rough-in (requires separate order of trim with same flow for complete product)

Flush Volume

- 48 = 1.27 gpf (4.8 Lpf) fixed
- 42 = 1.1 gpf (4.2 Lpf) fixed
- 19 = 0.5 gpf (1.9 Lpf) fixed
- 05 = 0.125 gpf (0.5 Lpf) fixed
- Blank = Adjustable

Flush Valves



1600T6 H₂Optics® Sensing Technology Electronic Flush Valve Trim ONLY – For Back Inlet Water Closet, Wall Hung Fixture
(Must order rough-in number separately AND trim for complete product. Use same flow.)

Model	Flow	Price	Finish
12" x 18" Frame with 14" x 20" Cover			
1600T6102ATR	1.6 gpf (6 Lpf) (ADJ)	594.15	Stainless Steel
1600T6102ATR-42	1.1 gpf (4.2 Lpf) (FXD)	594.15	Stainless Steel
12" Frame with 14" Cover			
1600T6103ATR	1.6 gpf (6 Lpf) (ADJ)	586.90	Stainless Steel

- Electronic concealed flush valve trim
- Requires separate order of BOTH rough-in AND trim
- Supplied as sensor, over-ride button and stainless steel cover
- Hands-free operation
- H₂Optics® Sensing Technology
- For 1-1/2" back spud
- Hardwire models, order transformer separately
- ADJ = field adjustable
- FXD = fixed flow



1600T6 H₂Optics® Sensing Technology Electronic Flush Valve Rough-In ONLY – For Back Inlet Water Closet, Wall Hung Fixture
(Must order trim number separately AND rough-in for complete product. Use same flow.)

Model	Flow	Price	Finish
12" x 18" Frame with 14" x 20" Cover			
1600T6102ARI	1.6 gpf (6 Lpf) (ADJ)	594.15	N/A
1600T6102ARI-42	1.1 gpf (4.2 Lpf) (FXD)	594.15	N/A
12" Frame with 14" Cover			
1600T6103ARI	1.6 gpf (6 Lpf) (ADJ)	586.90	N/A

- Electronic concealed flush valve rough
- Requires separate order of BOTH rough-in AND trim
- Supplied as complete flush valve, and wall box or access frame
- Hands-free operation
- H₂Optics® Sensing Technology
- For 1-1/2" back spud
- ADJ = field adjustable
- FXD = fixed flow

-42 models recommended for new construction ONLY.



1600T6 H₂Optics® Sensing Technology Electronic Flush Valve Trim ONLY
– For Back Inlet Urinal, Syphon Jet Fixture
 (Must order rough-in number separately AND trim for complete product. Use same flow.)

Model	Flow	Price	Finish
12" Frame with 14" Cover			
1600T6403ATR	0.5 gpf (1.9 Lpf) (ADJ)	572.40	Stainless Steel

- Electronic concealed flush valve trim
- Requires separate order of BOTH rough-in AND trim
- Supplied as sensor, over-ride button and stainless steel cover
- Hands-free operation
- H₂Optics® Sensing Technology
- For 3/4" back inlet
- When used for top inlet urinal, exposed tubing, flanges, elbow, etc., supplied by others
- Hardwire models, order transformer separately
- ADJ = field adjustable
- FXD = fixed flow



1600T6 H₂Optics® Sensing Technology Electronic Flush Valve Rough-In ONLY
– For Back Inlet Urinal, Syphon Jet Fixture
 (Must order trim number separately AND rough-in for complete product. Use same flow.)

Model	Flow	Price	Finish
12" Frame with 14" Cover			
1600T6403ARI	0.5 gpf (1.9 Lpf) (ADJ)	572.40	N/A

- Electronic concealed flush valve rough
- Requires separate order of BOTH rough-in AND trim
- Supplied as complete flush valve, and wall box or access frame
- Hands-free operation
- H₂Optics® Sensing Technology
- For 3/4" back inlet
- When used for top inlet urinal, exposed tubing, flanges, elbow, etc., supplied by others
- ADJ = field adjustable
- FXD = fixed flow



Hardwire Converter with Battery Backup

Model	Flow	Price	Finish
061047A	N/A	71.25	N/A

- Order separately

See page C62 for available transformers.

MODEL NUMBER EXAMPLE:
Configurations vary, see below for availability.

1600T9001TR

Fixture Type
1 = Back inlet
3 = Top inlet

Trim/Rough-In
TR = Trim
RI = Rough-in

1600T9 H₂Optics® Sensing Technology Electronic Washdown Urinal Valve Trim ONLY – Back Inlet (Must order rough-in number separately AND trim for complete product)



Model	Flow	Price	Finish
1600T9001TR 	N/A	463.75	Stainless Steel

- Electronic concealed valve for washdown urinals
- Requires separate order of BOTH rough-in AND trim
- Hands-free operation
- H₂Optics® Sensing Technology
- Stainless steel cover with integral sensor
- For back inlet urinal
- Hardwire models, order transformer separately
- Field adjustable

Rough-in ONLY – For Use with Trim (Must order trim number separately AND rough-in for complete product)



Model	Flow	Price	Finish
1600T9001RI 	0.5 gpf (1.9 Lpf)	463.75	N/A

- Rough-in ONLY, for use with back inlet trim
- Recessed 8" box, outlet hose
- Must order TRIM for complete model

1600T9 H₂Optics® Sensing Technology Electronic Washdown Urinal Valve Trim ONLY – Top Inlet (Must order rough-in number separately AND trim for complete product)



Model	Flow	Price	Finish
1600T9003TR 	N/A	449.35	Stainless Steel

- Electronic concealed valve for washdown urinals
- Requires separate order of BOTH rough-in AND trim
- Hands-free operation
- H₂Optics® Sensing Technology
- Stainless steel cover with integral sensor
- For top inlet urinal
- When used for top inlet urinal, exposed tubing, flanges, elbow, etc., supplied by others
- Hardwire models, order transformer separately
- Field adjustable

Rough-in ONLY – For Use with Trim (Must order trim number separately AND rough-in for complete product)

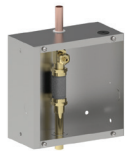

Model	Flow	Price	Finish
1600T9003RI 	0.5 gpf (1.9 Lpf)	449.35	N/A

- Rough-in ONLY, for use with top inlet trim
- Recessed 8" box
- When used for top inlet urinal, exposed tubing, flanges, elbow, etc., supplied by others
- Must order TRIM for complete model

Hardwire Converter with Battery Backup



Model	Flow	Price	Finish
061047A	N/A	71.25	N/A

- Order separately

Models must be installed on fixtures providing sufficient air gap protection against backflow. See page C62 for available transformers.



Lavatory

MODEL NUMBER EXAMPLE:

Configurations vary, see below for availability.

21C144-TI

Variation

- 1 = Less pop-up, no pop-up hole
- 2 = Metal pop-up
- 3 = Cast open grid strainer
- 4 = Cast ADA offset open grid strainer
- 5 = Chain stay

Outlet

- 2 = Vandal resistant laminar outlet (VRLAM)
- 3 = Vandal resistant aerator (VR)
- 4 = Standard aerator outlet (STD)
- 5 = Vandal resistant spray outlet (VRS)
- 9 = Vandal resistant spray outlet (VRS)

Handle

- 1 = 5-Fluted
- 2 = Hooded blade
- 3 = Hooded lever
- 4 = Blade w/sanitary hood
- 5 = Wrist w/sanitary hood
- 8 = Self-closing hooded lever
- 9 = Self-closing 5-Fluted

TI = Handle temperature indicators
 "H" (red), "C" (blue)



CER-TECK® 21C1 with 5-Fluted Handle – Less Pop-Up

Model	Flow	Price	Finish
21C121	1.5 gpm (5.7 L/min) (VRLAM)	214.95	Chrome
21C131	1.5 gpm (5.7 L/min) (VR)	203.40	Chrome
21C141	1.5 gpm (5.7 L/min) (STD)	198.95	Chrome
21C151	0.5 gpm (1.9 L/min) (VRS)	214.95	Chrome

- 2-hole 4" installation
- 5.1" long, 3.6" high
- Cast brass body
- Vandal resistant handles
- Red/blue indicators
- No pop-up hole
- 1.75" max. deck thickness
- CER-TECK® cartridges

Self-Closing Handle

21C149	1.5 gpm (5.7 L/min) (STD)	234.65	Chrome
--------	---------------------------	--------	--------

CER-TECK® 21C1 with 4" (102 mm) Hooded Blade Handle – Less Pop-Up



Model	Flow	Price	Finish
21C122	1.5 gpm (5.7 L/min) (VRLAM)	217.10	Chrome
21C132	1.5 gpm (5.7 L/min) (VR)	205.65	Chrome
21C132-TI	1.5 gpm (5.7 L/min) (VR)	219.05	Chrome
21C142	1.5 gpm (5.7 L/min) (STD)	201.15	Chrome
21C152	0.5 gpm (1.9 L/min) (VRS)	217.10	Chrome
21C152-TI	0.5 gpm (1.9 L/min) (VRS)	230.65	Chrome

- 2-hole 4" installation
- 5.1" long, 3.6" high
- Cast brass body
- Vandal resistant handles
- Red/blue indicators
- No pop-up hole
- 1.75" max. deck thickness
- CER-TECK® cartridges

CER-TECK® 21C1 with 3" (76 mm) Hooded Lever Handle – Less Pop-Up



Model	Flow	Price	Finish
21C123	1.5 gpm (5.7 L/min) (VRLAM)	215.45	Chrome
21C133	1.5 gpm (5.7 L/min) (VR)	204.00	Chrome
21C133-TI	1.5 gpm (5.7 L/min) (VR)	217.50	Chrome
21C143	1.5 gpm (5.7 L/min) (STD)	199.50	Chrome
21C143-TI	1.5 gpm (5.7 L/min) (STD)	213.00	Chrome
21C153	0.5 gpm (1.9 L/min) (VRS)	215.45	Chrome
21C153-TI	0.5 gpm (1.9 L/min) (VRS)	229.00	Chrome

- 2-hole 4" installation
- 5.1" long, 3.6" high
- Cast brass body
- Vandal resistant handles
- Red/blue indicators
- No pop-up hole
- 1.75" max. deck thickness
- CER-TECK® cartridges

Self-Closing Handle

21C138	1.5 gpm (5.7 L/min) (VR)	239.10	Chrome
21C148	1.5 gpm (5.7 L/min) (STD)	234.65	Chrome

Lavatory



CER-TECK® 21C1 with 4" (102 mm) Blade Handle with Sanitary Hood – Less Pop-Up

Model	Flow	Price	Finish
21C124	1.5 gpm (5.7 L/min) (VRLAM)	252.40	Chrome
21C124-TI	1.5 gpm (5.7 L/min) (VRLAM)	266.60	Chrome
21C134	1.5 gpm (5.7 L/min) (VR)	240.25	Chrome
21C134-TI	1.5 gpm (5.7 L/min) (VR)	254.50	Chrome
21C144	1.5 gpm (5.7 L/min) (STD)	235.50	Chrome
21C144-TI	1.5 gpm (5.7 L/min) (STD)	249.85	Chrome
21C154	0.5 gpm (1.9 L/min) (VRS)	252.40	Chrome
21C154-TI	0.5 gpm (1.9 L/min) (VRS)	266.60	Chrome

- 2-hole 4" installation
- 5.1" long, 3.6" high
- Cast brass body
- Vandal resistant handles
- Red/blue indicators
- No pop-up hole
- 1.75" max. deck thickness
- CER-TECK® cartridges



CER-TECK® 21C1 with 6" (152 mm) Wrist Handle with Sanitary Hood – Less Pop-Up

Model	Flow	Price	Finish
21C135	1.5 gpm (5.7 L/min) (VR)	260.95	Chrome
21C145	1.5 gpm (5.7 L/min) (STD)	256.45	Chrome
21C155	0.5 gpm (1.9 L/min) (VRS)	272.45	Chrome

- 2-hole 4" installation
- 5.1" long, 3.6" high
- Cast brass body
- Vandal resistant handles
- Red/blue indicators
- No pop-up hole
- 1.75" max. deck thickness
- CER-TECK® cartridges



CER-TECK® 21C2 with 5-Fluted Handle and Metal Pop-Up

Model	Flow	Price	Finish
21C231	1.5 gpm (5.7 L/min) (VR)	270.40	Chrome
21C241	1.5 gpm (5.7 L/min) (STD)	266.00	Chrome

- 3-hole 4" installation
- 5.1" long, 3.6" high
- Cast brass body
- Vandal resistant handles
- Red/blue indicators
- Metal pop-up
- 1.75" max. deck thickness
- CER-TECK® cartridges



CER-TECK® 21C2 with 4" (102 mm) Hooded Blade Handle and Metal Pop-Up

Model	Flow	Price	Finish
21C232	1.5 gpm (5.7 L/min) (VR)	272.65	Chrome
21C242	1.5 gpm (5.7 L/min) (STD)	268.15	Chrome
21C252-TI	0.5 gpm (1.9 L/min) (VRS)	297.70	Chrome

- 3-hole 4" installation
- 5.1" long, 3.6" high
- Cast brass body
- Vandal resistant handles
- Red/blue indicators
- Metal pop-up
- 1.75" max. deck thickness
- CER-TECK® cartridges



CER-TECK® 21C2 with 3" (76 mm) Hooded Lever Handle and Metal Pop-Up

Model	Flow	Price	Finish
21C233	1.5 gpm (5.7 L/min) (VR)	271.10	Chrome
21C243	1.5 gpm (5.7 L/min) (STD)	266.60	Chrome
21C253	0.5 gpm (1.9 L/min) (VRS)	282.55	Chrome

- 3-hole 4" installation
- 5.1" long, 3.6" high
- Cast brass body
- Vandal resistant handles
- Red/blue indicators
- Metal pop-up
- 1.75" max. deck thickness
- CER-TECK® cartridges



CER-TECK® 21C2 with 4" (102 mm) Blade Handle with Sanitary Hood and Metal Pop-Up

Model	Flow	Price	Finish
21C224	1.5 gpm (5.7 L/min) (VRLAM)	306.30	Chrome
21C234	1.5 gpm (5.7 L/min) (VR)	310.95	Chrome
21C244	1.5 gpm (5.7 L/min) (STD)	306.35	Chrome
21C254	0.5 gpm (1.9 L/min) (VRS)	306.30	Chrome

- 3-hole 4" installation
- 5.1" long, 3.6" high
- Cast brass body
- Vandal resistant handles
- Red/blue indicators
- Metal pop-up
- 1.75" max. deck thickness
- CER-TECK® cartridges



CER-TECK® 21C3 with 3" (76 mm) Hooded Lever Handle and Open Grid Strainer

Model	Flow	Price	Finish
21C333	1.5 gpm (5.7 L/min) (VR)	234.25	Chrome

- 2-hole 4" installation
- 5.1" long, 3.6" high
- Cast brass body
- Vandal resistant handles
- Red/blue indicators
- Cast open grid strainer
- 1.75" max. deck thickness
- CER-TECK® cartridges



CER-TECK® 21C34 with 4" (102 mm) Blade Handle with Sanitary Hood and Open Grid Strainer

Model	Flow	Price	Finish
21C334	1.5 gpm (5.7 L/min) (VR)	272.15	Chrome

- 2-hole 4" installation
- 5.1" long, 3.6" high
- Cast brass body
- Vandal resistant handles
- Red/blue indicators
- Cast open grid strainer
- 1.75" max. deck thickness
- CER-TECK® cartridges



CER-TECK® 21C4 with 3" (76 mm) Hooded Lever Handle and Offset Open Grid Strainer

Model	Flow	Price	Finish
21C453	0.5 gpm (1.9 L/min) (VRS)	271.00	Chrome

- 2-hole 4" installation
- 5.1" long, 3.6" high
- Cast brass body
- Vandal resistant handles
- Red/blue indicators
- Cast ADA offset open grid strainer
- 1.75" max. deck thickness
- CER-TECK® cartridges



CER-TECK® 21C4 with 4" (102 mm) Blade Handle with Sanitary Hood and Offset Open Grid Strainer

Model	Flow	Price	Finish
21C424	1.5 gpm (5.7 L/min) (VRLAM)	310.90	Chrome

- 2-hole 4" installation
- 5.1" long, 3.6" high
- Cast brass body
- Vandal resistant handles
- Red/blue indicators
- Cast ADA offset open grid strainer
- 1.75" max. deck thickness
- CER-TECK® cartridges



CER-TECK® 21C5 with 4" (102 mm) Hooded Blade Handle and Chain Stay

Model	Flow	Price	Finish
21C542	1.5 gpm (5.7 L/min) (STD)	205.25	Chrome

- 2-hole 4" installation
- 5.1" long, 3.6" high
- Cast brass body
- Vandal resistant handles
- Red/blue indicators
- With chain stay (for plug and chain)
- 1.75" max. deck thickness
- CER-TECK® cartridges



CER-TECK® 21C5 with 3" (76 mm) Hooded Lever Handle and Chain Stay

Model	Flow	Price	Finish
21C553	0.5 gpm (1.9 L/min) (VRS)	219.60	Chrome

- 2-hole 4" installation
- 5.1" long, 3.6" high
- Cast brass body
- Vandal resistant handles
- Red/blue indicators
- With chain stay (for plug and chain)
- 1.75" max. deck thickness
- CER-TECK® cartridges

See pages C125-C126 for drainage.

Lavatory

MODEL NUMBER EXAMPLE:

Configurations vary, see below for availability.

22C151

Variation

- 0 = 4" Less pop-up, with pop-up hole
- 1 = 4" Less pop-up, no pop-up hole
- 3 = 4" with metal pop-up
- 4 = 4" with open grid strainer
- 5 = 4" with ADA offset open grid strainer
- 6 = Single hole, less pop-up, no pop-up hole
- 8 = Single hole with metal pop-up
- 9 = Single hole with open grid strainer

Outlet

- 0 = Vandal resistant aerator outlet (VR)
- 2 = Vandal resistant laminar outlet (VRLAM)
- 3 = Vandal resistant aerator (VR)
- 4 = Standard aerator outlet (STD)
- 5 = Vandal resistant spray outlet (VRS)
- 9 = Vandal resistant spray outlet (VRS)

Handle

- 1 = 3 1/2" (89 mm) lever



22C0 – 4" Centerset – Less Pop-up, with Pop-up Hole

Model	Flow	Price	Finish
22C001	1.5 gpm (5.7 L/min) (VR)	224.65	Chrome
22C021	1.5 gpm (5.7 L/min) (VRLAM)	239.75	Chrome
22C041	1.5 gpm (5.7 L/min) (STD)	222.90	Chrome
22C051	0.5 gpm (1.9 L/min) (VRS)	239.75	Chrome

- 3-hole 4" installation
- 5.9" long, 5.3" high
- Cast brass body
- Vandal resistant 3 1/2" (89 mm) lever handle
- Red/blue indicator
- 1.18" max. deck thickness
- 1/2" IPS shanks
- Ceramic cartridge with rotational limit stop



22C1 – 4" Centerset – Less Pop-up, No Pop-up Hole

Model	Flow	Price	Finish
22C101	1.5 gpm (5.7 L/min) (VR)	209.35	Chrome
22C121	1.5 gpm (5.7 L/min) (VRLAM)	224.45	Chrome
22C131	1.5 gpm (5.7 L/min) (VR)	212.30	Chrome
22C141	1.5 gpm (5.7 L/min) (STD)	207.65	Chrome
22C151	0.5 gpm (1.9 L/min) (VRS)	224.45	Chrome
22C191	0.35 gpm (1.3 L/min) (VRS)	224.45	Chrome

- 2-hole 4" installation
- 5.9" long, 5.3" high
- Cast brass body
- Vandal resistant 3 1/2" (89 mm) lever handle
- Red/blue indicator
- 1.18" max. deck thickness
- 1/2" IPS shanks
- Ceramic cartridge with rotational limit stop



22C3 – 4" Centerset with Metal Pop-up

Model	Flow	Price	Finish
22C301	1.5 gpm (5.7 L/min) (VR)	247.70	Chrome
22C321	1.5 gpm (5.7 L/min) (VRLAM)	262.80	Chrome
22C331	1.5 gpm (5.7 L/min) (VR)	250.65	Chrome
22C341	1.5 gpm (5.7 L/min) (STD)	245.95	Chrome
22C351	0.5 gpm (1.9 L/min) (VRS)	262.80	Chrome

- 3-hole 4" installation
- 5.9" long, 5.3" high
- Cast brass body
- Vandal resistant 3 1/2" (89 mm) lever handle
- Red/blue indicator
- 1.18" max. deck thickness
- 1/2" IPS shanks
- Ceramic cartridge with rotational limit stop



22C4 – 4" Centerset with Open Grid Strainer

Model	Flow	Price	Finish
22C401	1.5 gpm (5.7 L/min) (VR)	234.80	Chrome
22C451	0.5 gpm (1.9 L/min) (VRS)	249.90	Chrome

- 2-hole 4" installation
- 5.9" long, 5.3" high
- Cast brass body
- Vandal resistant 3 1/2" (89 mm) lever handle
- Red/blue indicator
- 1.18" max. deck thickness
- 1/2" IPS shanks
- Ceramic cartridge with rotational limit stop

Lavatory



22C5 – 4" Centerset with ADA Offset Open Grid Strainer

Model	Flow	Price	Finish
22C531	1.5 gpm (5.7 L/min) (VR)	259.90	Chrome
22C551	0.5 gpm (1.9 L/min) (VRS)	272.10	Chrome

- 2-hole 4" installation
- 5.9" long, 5.3" high
- Cast brass body
- Vandal resistant 3 1/2" (89 mm) lever handle
- Red/blue indicator
- 1.18" max. deck thickness
- 1/2" IPS shanks
- Ceramic cartridge with rotational limit stop



22C6 Single Hole Mount – Less Pop-up, No Pop-up Hole

Model	Flow	Price	Finish
22C601	1.5 gpm (5.7 L/min) (VR)	231.65	Chrome
22C621	1.5 gpm (5.7 L/min) (VRLAM)	246.70	Chrome
22C631	1.5 gpm (5.7 L/min) (VR)	234.50	Chrome
22C641	1.5 gpm (5.7 L/min) (STD)	229.80	Chrome
22C651	0.5 gpm (1.9 L/min) (VRS)	246.70	Chrome
22C691	0.35 gpm (1.3 L/min) (VRS)	246.70	Chrome

- 1-hole installation
- 5.3" long, 5.3" high
- Cast brass body
- Vandal resistant 3 1/2" (89 mm) lever handle
- Red/blue indicator
- 2.13" max. deck thickness
- 3/8" compression fittings
- Ceramic cartridge with rotational limit stop



22C8 Single Hole Mount with Metal Pop-up

Model	Flow	Price	Finish
22C801	1.5 gpm (5.7 L/min) (VR)	259.90	Chrome
22C831	1.5 gpm (5.7 L/min) (VR)	262.75	Chrome
22C851	0.5 gpm (1.9 L/min) (VRS)	274.20	Chrome

- 1-hole installation
- 5.3" long, 5.3" high
- Cast brass body
- Vandal resistant 3 1/2" (89 mm) lever handle
- Red/blue indicator
- 2.13" max. deck thickness
- 3/8" compression fittings
- Ceramic cartridge with rotational limit stop



22C9 Single Hole Mount with Open Grid Strainer

Model	Flow	Price	Finish
22C901	1.5 gpm (5.7 L/min) (VR)	259.90	Chrome
22C951	0.5 gpm (1.9 L/min) (VRS)	275.00	Chrome

- 1-hole installation
- 5.3" long, 5.3" high
- Cast brass body
- Vandal resistant 3 1/2" (89 mm) lever handle
- Red/blue indicator
- 2.13" max. deck thickness
- 3/8" compression fittings
- Ceramic cartridge with rotational limit stop



See pages C125-C126 for drainage.

Lavatory

MODEL NUMBER EXAMPLE:
Configurations vary, see below for availability.

23C 3 3 4 - TI

Variation
3 = Cast spout
6 = Gooseneck spout

Outlet
2 = Vandal resistant laminar outlet (VRLAM)
3 = Vandal resistant aerator (VR)
4 = Standard aerator outlet (STD)
5 = Vandal resistant spray outlet (VRS)
7 = Smooth end, laminar outlet (SELAM)

Handle
2 = Hooded blade
3 = Hooded lever
4 = Blade w/sanitary hood
5 = Wrist w/sanitary hood

TI = Handle temperature indicators
"H" (red), "C" (blue)
R* = Optional gooseneck
spout dimensions:
R4 = 6" long, 11.8" high
R7 = 9" long, 14.2" high

CER-TECK® 23C3 Cast Spout – 4" (102 mm) Hooded Blade Handle



Model	Flow	Price	Finish
23C322	1.5 gpm (5.7 L/min) (VRLAM)	356.35	Chrome
23C332	1.5 gpm (5.7 L/min) (VR)	326.20	Chrome
23C342	1.5 gpm (5.7 L/min) (STD)	339.55	Chrome
23C352	0.5 gpm (1.9 L/min) (VRS)	337.75	Chrome

- 3-hole, 6 - 12" installation
- 4.5" long, 2.6" high
- Rigid cast spout and body
- Vandal resistant handles
- Red/blue indicators
- 1.06" max. deck thickness
- CER-TECK® cartridges

CER-TECK® 23C3 Cast Spout – 3" (76 mm) Hooded Lever Handle



Model	Flow	Price	Finish
23C323	1.5 gpm (5.7 L/min) (VRLAM)	354.70	Chrome
23C333	1.5 gpm (5.7 L/min) (VR)	324.65	Chrome
23C343	1.5 gpm (5.7 L/min) (STD)	337.75	Chrome
23C353	0.5 gpm (1.9 L/min) (VRS)	336.20	Chrome

- 3-hole, 6 - 12" installation
- 4.5" long, 2.6" high
- Rigid cast spout and body
- Vandal resistant handles
- Red/blue indicators
- 1.06" max. deck thickness
- CER-TECK® cartridges

CER-TECK® 23C3 Cast Spout – 4" (102 mm) Blade Handle with Sanitary Hood



Model	Flow	Price	Finish
23C324	1.5 gpm (5.7 L/min) (VRLAM)	379.60	Chrome
23C334	1.5 gpm (5.7 L/min) (VR)	367.55	Chrome
23C344	1.5 gpm (5.7 L/min) (STD)	343.90	Chrome
23C354	0.5 gpm (1.9 L/min) (VRS)	379.60	Chrome

- 3-hole, 6 - 12" installation
- 4.5" long, 2.6" high
- Rigid cast spout and body
- Vandal resistant handles
- Red/blue indicators
- 1.06" max. deck thickness
- CER-TECK® cartridges

CER-TECK® 23C3 Cast Spout – 6" (152 mm) Wrist Handle with Sanitary Hood



Model	Flow	Price	Finish
23C335	1.5 gpm (5.7 L/min) (VR)	402.55	Chrome

- 3-hole, 6 - 12" installation
- 4.5" long, 2.6" high
- Rigid cast spout and body
- Vandal resistant handles
- Red/blue indicators
- 1.06" max. deck thickness
- CER-TECK® cartridges

Lavatory



CER-TECK® 23C6 Gooseneck Spout – 4" (102 mm) Hooded Blade Handle

Model		Flow	Price	Finish
23C622		1.5 gpm (5.7 L/min) (VRLAM)	332.60	Chrome
23C622-R4		1.5 gpm (5.7 L/min) (VRLAM)	339.65	Chrome
23C632		1.5 gpm (5.7 L/min) (VR)	303.80	Chrome
23C632-R7		1.5 gpm (5.7 L/min) (VR)	352.10	Chrome
23C642		1.5 gpm (5.7 L/min) (STD)	299.30	Chrome
23C642-R4		1.5 gpm (5.7 L/min) (STD)	322.90	Chrome
23C642-R7		1.5 gpm (5.7 L/min) (STD)	315.10	Chrome
23C652		0.5 gpm (1.9 L/min) (VRS)	332.60	Chrome

- 3-hole, 6 - 12" installation
- 4.5" long, 12" high
- Rigid/swivel gooseneck spout
- Cast body
- Vandal resistant handles
- Red/blue indicators
- 1.06" max. deck thickness
- CER-TECK® cartridges
- R* = Optional gooseneck spout dimensions:
 R4 = 6" long, 11.8" high
 R7 = 9" long, 14.2" high

Smooth End Gooseneck

23C672		1.0 gpm (3.8 L/min) (SELAM)	315.25	Chrome
23C672-R4TI		1.0 gpm (3.8 L/min) (SELAM)	353.90	Chrome
23C672-R7		1.0 gpm (3.8 L/min) (SELAM)	364.20	Chrome



CER-TECK® 23C6 Gooseneck Spout – 3" (76 mm) Hooded Lever Handle

Model		Flow	Price	Finish
23C633		1.5 gpm (5.7 L/min) (VR)	318.80	Chrome
23C643		1.5 gpm (5.7 L/min) (STD)	297.75	Chrome
23C653		0.5 gpm (1.9 L/min) (VRS)	331.00	Chrome

- 3-hole, 6 - 12" installation
- 4.5" long, 12" high
- Rigid/swivel gooseneck spout
- Cast body
- Vandal resistant handles
- Red/blue indicators
- 1.06" max. deck thickness
- CER-TECK® cartridges
- R* = Optional gooseneck spout dimensions:
 R4 = 6" long, 11.8" high
 R7 = 9" long, 14.2" high

Smooth End Gooseneck

23C673		1.0 gpm (3.8 L/min) (SELAM)	331.00	Chrome
--------	--	-----------------------------	--------	--------

Lavatory



CER-TECK® 23C6 Gooseneck Spout – 4" (102 mm) Blade Handle with Sanitary Hood

Model	Flow	Price	Finish
23C624	1.5 gpm (5.7 L/min) (VRLAM)	356.05	Chrome
23C624-R4	1.5 gpm (5.7 L/min) (VRLAM)	362.95	Chrome
23C624-R7	1.5 gpm (5.7 L/min) (VRLAM)	387.50	Chrome
23C634	1.5 gpm (5.7 L/min) (VR)	325.90	Chrome
23C634-R4	1.5 gpm (5.7 L/min) (VR)	350.90	Chrome
23C644	1.5 gpm (5.7 L/min) (STD)	339.15	Chrome
23C644-R4	1.5 gpm (5.7 L/min) (STD)	346.20	Chrome
23C644-R7	1.5 gpm (5.7 L/min) (STD)	370.70	Chrome
23C654	0.5 gpm (1.9 L/min) (VRS)	337.45	Chrome

- 3-hole, 6 - 12" installation
- 4.5" long, 12" high
- Rigid/swivel gooseneck spout
- Cast body
- Vandal resistant handles
- Red/blue indicators
- 1.06" max. deck thickness
- CER-TECK® cartridges
- R* = Optional gooseneck spout dimensions:
R4 = 6" long, 11.8" high
R7 = 9" long, 14.2" high

Smooth End Gooseneck

23C674	1.0 gpm (3.8 L/min) (SELAM)	356.05	Chrome
23C674-R4	1.0 gpm (3.8 L/min) (SELAM)	362.95	Chrome
23C674-R7	1.0 gpm (3.8 L/min) (SELAM)	387.50	Chrome
23C674-TI	1.0 gpm (3.8 L/min) (SELAM)	370.20	Chrome



CER-TECK® 23C6 Gooseneck spout – 6" (152 mm) Wrist Handle with Sanitary Hood

Model	Flow	Price	Finish
23C625	1.5 gpm (5.7 L/min) (VRLAM)	391.05	Chrome
23C645-R7	1.5 gpm (5.7 L/min) (STD)	405.75	Chrome

- 3-hole, 6 - 12" installation
- 4.5" long, 12" high
- Rigid/swivel gooseneck spout
- Cast body
- Vandal resistant handles
- Red/blue indicators
- 1.06" max. deck thickness
- CER-TECK® cartridges
- R* = Optional gooseneck spout dimensions:
R4 = 6" long, 11.8" high
R7 = 9" long, 14.2" high

MODEL NUMBER EXAMPLE:
Configurations vary, see below for availability.

24T2623 - R4

Variation
6 = Gooseneck spout

Outlet
2 = Vandal resistant laminar outlet (VRLAM)
3 = Vandal resistant aerator (VR)
4 = Standard aerator outlet (STD)
5 = Vandal resistant spray outlet (VRS)
7 = Smooth end, laminar outlet (SELAM)

Handle
3 = 6" (152 mm) Lever blade

R* = Optional gooseneck spout dimensions:
R4 = 6" long, 12" high
R7 = 9" long, 14.3" high



24T26 Gooseneck Spout – 6" (152 mm) Lever Blade Handle

Model	ADA	Flow	Price	Finish
24T2623		1.5 gpm (5.7 L/min) (VRLAM)	400.40	Chrome
24T2623-R4		1.5 gpm (5.7 L/min) (VRLAM)	407.40	Chrome
24T2633		1.5 gpm (5.7 L/min) (VR)	388.30	Chrome
24T2633-R7		1.5 gpm (5.7 L/min) (VR)	419.80	Chrome
24T2643		1.5 gpm (5.7 L/min) (STD)	383.55	Chrome
24T2643-R4		1.5 gpm (5.7 L/min) (STD)	390.60	Chrome
24T2643-R7		1.5 gpm (5.7 L/min) (STD)	415.20	Chrome
24T2653		0.5 gpm (1.9 L/min) (VRS)	400.40	Chrome

Smooth End Gooseneck

24T2673		1.0 gpm (3.8 L/min) (SELAM)	400.40	Chrome
24T2673-R4		1.0 gpm (3.8 L/min) (SELAM)	407.40	Chrome

- 2-hole installation
- 4 - 16" (102 - 406 mm) adjustable centers
- 4.5" long, 12.1" high
- Rigid/swivel gooseneck spout
- Vandal resistant handle
- Delta® stainless steel ball cartridge
- High temperature limit stop
- 1.56" max. deck thickness
- For commercial use only
- **R*** = Optional gooseneck spout dimensions:
R4 = 6" long, 12" high
R7 = 9" long, 14.3" high

24T Control Unit/Valve Only 6" (152 mm) Lever Blade Handle

Model	ADA	Flow	Price	Finish
24T0003		N/A	245.75	Chrome

- Control unit/valve only
- Vandal resistant handle
- Delta® stainless steel ball cartridge
- High temperature limit stop
- 1.56" max. deck thickness
- For commercial use only



MODEL NUMBER EXAMPLE:
Configurations vary, see below for availability.

25C3 9 3 7 - R7

Variation

8 = 4.5" (114 mm) gooseneck spout
9 = 6" (152 mm) gooseneck spout

Outlet

2 = Vandal resistant laminar outlet (VRLAM)
3 = Vandal resistant aerator (VR)
4 = Standard aerator outlet (STD)
5 = Vandal resistant spray outlet (VRS)
7 = Smooth end, laminar outlet (SELAM)

Handle

7 = 2.5" (63.5 mm)
balanced lever blade

R* = Optional gooseneck

spout dimensions:
R7 = 9" long, 16.2" high



CER-TECK® 25C3 Gooseneck Spout – 2.5" (63.5 mm) Balanced Lever Blade Handle

Model	Flow	Price	Finish
25C3827	1.5 gpm (5.7 L/min) (VRLAM)	328.45	Chrome
25C3837	1.5 gpm (5.7 L/min) (VR)	328.45	Chrome
25C3847	1.5 gpm (5.7 L/min) (STD)	311.65	Chrome

Smooth End Gooseneck

25C3877	1.0 gpm (3.8 L/min) (SELAM)	328.45	Chrome
---------	-----------------------------	--------	--------

- 1-hole installation
- Cast body
- 4.5" long, 14" high
- Rigid/swivel gooseneck spout
- Vandal resistant handle
- Red/blue indicators
- 2" max. deck thickness
- CER-TECK® cartridges



CER-TECK® 25C3 Gooseneck Spout – 2.5" (63.5 mm) Balanced Lever Blade Handle

Model	Flow	Price	Finish
25C3927	1.5 gpm (5.7 L/min) (VRLAM)	328.45	Chrome
25C3937	1.5 gpm (5.7 L/min) (VR)	316.35	Chrome
25C3937-R7	1.5 gpm (5.7 L/min) (VR)	347.90	Chrome
25C3947	1.5 gpm (5.7 L/min) (STD)	311.65	Chrome
25C3947-R7	1.5 gpm (5.7 L/min) (STD)	343.25	Chrome
25C3957	0.5 gpm (1.9 L/min) (VRS)	328.45	Chrome

Smooth End Gooseneck

25C3977	1.0 gpm (3.8 L/min) (SELAM)	328.45	Chrome
---------	-----------------------------	--------	--------

- 1-hole installation
- Cast body
- 6.0" long, 13.9" high
- Rigid/swivel gooseneck spout
- Vandal resistant handle
- Red/blue indicators
- 2" max. deck thickness
- CER-TECK® cartridges
- **R*** = Optional gooseneck spout dimensions:
R7 = 9" long, 16.2" high



Coverplate for Field Conversion

Model	Flow	Price	Finish
060585A	N/A	109.10	Chrome

- 4" (102 mm) coverplate



entials.
antibacterial
denture cleanser
with baking soda
Fights odour
kills bacteria that
cause denture odour
effective against moulds fungi

Directions for daily use
1. Place dentures in solution for 15-20 minutes
2. Rinse dentures with water and brush with a soft toothbrush
3. Soak dentures in solution for 15-20 minutes
4. Rinse dentures with water and brush with a soft toothbrush
5. Soak dentures in solution for 15-20 minutes
6. Rinse dentures with water and brush with a soft toothbrush
7. Soak dentures in solution for 15-20 minutes
8. Rinse dentures with water and brush with a soft toothbrush

108 tablets VALUE SIZE



Sink Faucets

MODEL NUMBER EXAMPLE:
Configurations vary, see below for availability.

26C3 9 3 3 - LS

Variation

- 1 = 8" (203 mm) Wallform spout
- 2 = 8" (203 mm) Tubular spout
- 9 = 6" (152 mm) Gooseneck spout

Outlet

- 2 = Vandal resistant laminar outlet (VRLAM)
- 3 = Vandal resistant aerator (VR)
- 4 = Standard aerator outlet (STD)
- 5 = Vandal resistant spray outlet (VRS)
- 7 = Smooth end, laminar outlet (SELAM)

Handle

- 1 = 5-fluted
- 2 = Hooded blade
- 3 = Hooded lever
- 4 = Blade with sanitary hood
- 5 = Wrist with sanitary hood

- LS = 120° Limited swing gooseneck
- TI = Handle temperature indicators "H" (red), "C" (blue)

- R* = Optional gooseneck: spout dimensions:
R2 = 4.5" long, 11.7" high
R5 = 6" long, 13.2" high
R6 = 6" long, 14.8" high
R7 = 9" long, 13.9" high

- S* = Optional swing spout dimensions:
S3 = 6" Tubular
S7 = 11" Tubular
S8 = 14" Tubular



CER-TECK® 26C3 with 8" Wallform Spout – 5-Fluted Handle

Model	Flow	Price	Finish
26C3131	1.5 gpm (5.7 L/min) (VR)	296.20	Chrome
26C3141	1.5 gpm (5.7 L/min) (STD)	291.75	Chrome

- 3-hole 8" installation
- 8" long spout, swings 360°
- Cast body
- Vandal resistant handles
- Red/blue indicators
- 1/2" IPS shanks
- 1.75" max. deck thickness
- CER-TECK® cartridges



CER-TECK® 26C3 with 8" Wallform Spout – 4" (102 mm) Hooded Blade Handle

Model	Flow	Price	Finish
26C3122	1.5 gpm (5.7 L/min) (VRLAM)	309.90	Chrome
26C3132	1.5 gpm (5.7 L/min) (VR)	298.35	Chrome
26C3142	1.5 gpm (5.7 L/min) (STD)	294.00	Chrome
26C3152	0.5 gpm (1.9 L/min) (VRS)	309.90	Chrome

- 3-hole 8" installation
- 8" long spout, swings 360°
- Cast body
- Vandal resistant handles
- Red/blue indicators
- 1/2" IPS shanks
- 1.75" max. deck thickness
- CER-TECK® cartridges



CER-TECK® 26C3 with 8" Wallform Spout – 3" (76 mm) Hooded Lever Handle

Model	Flow	Price	Finish
26C3123	1.5 gpm (5.7 L/min) (VRLAM)	308.20	Chrome
26C3133	1.5 gpm (5.7 L/min) (VR)	296.75	Chrome
26C3133-TI	1.5 gpm (5.7 L/min) (VR)	310.25	Chrome
26C3143	1.5 gpm (5.7 L/min) (STD)	292.25	Chrome
26C3153	0.5 gpm (1.9 L/min) (VRS)	308.20	Chrome

- 3-hole 8" installation
- 8" long spout, swings 360°
- Cast body
- Vandal resistant handles
- Red/blue indicators
- 1/2" IPS shanks
- 1.75" max. deck thickness
- CER-TECK® cartridges



CER-TECK® 26C3 with 8" Wallform Spout – 4" (102 mm) Blade Handle with Sanitary Hood

Model	Flow	Price	Finish
26C3124	1.5 gpm (5.7 L/min) (VRLAM)	331.95	Chrome
26C3134	1.5 gpm (5.7 L/min) (VR)	320.55	Chrome
26C3144	1.5 gpm (5.7 L/min) (STD)	333.45	Chrome
26C3154	0.5 gpm (1.9 L/min) (VRS)	350.25	Chrome

- 3-hole 8" installation
- 8" long spout, swings 360°
- Cast body
- Vandal resistant handles
- Red/blue indicators
- 1/2" IPS shanks
- 1.75" max. deck thickness
- CER-TECK® cartridges



CER-TECK® 26C3 with 8" Wallform Spout – 6" (152 mm) Wrist Handle with Sanitary Hood

Model	Flow	Price	Finish
26C3155 	0.5 gpm (1.9 L/min) (VRS)	385.30	Chrome

- 3-hole 8" installation
- 8" long spout, swings 360°
- Cast body
- Vandal resistant handles
- Red/blue indicators
- 1/2" IPS shanks
- 1.75" max. deck thickness
- CER-TECK® cartridges









CER-TECK® 26C3 with 8" Tubular Spout – 5-Fluted Handle

Model	Flow	Price	Finish
26C3221	1.5 gpm (5.7 L/min) (VRLAM)	280.25	Chrome
26C3231	1.5 gpm (5.7 L/min) (VR)	268.80	Chrome
26C3241	1.5 gpm (5.7 L/min) (STD)	264.30	Chrome

- 3-hole 8" installation
- 8" long spout, swings 360°
- Cast body
- Vandal resistant handles
- Red/blue indicators
- 1/2" IPS shanks
- 1.75" max. deck thickness
- CER-TECK® cartridges













CER-TECK® 26C3 with 8" Tubular Spout – 4" (102 mm) Hooded Blade Handle

Model	Flow	Price	Finish
26C3222 	1.5 gpm (5.7 L/min) (VRLAM)	282.50	Chrome
26C3232 	1.5 gpm (5.7 L/min) (VR)	271.00	Chrome
26C3232-S7 	1.5 gpm (5.7 L/min) (VR)	281.60	Chrome
26C3242 	1.5 gpm (5.7 L/min) (STD)	266.55	Chrome
26C3242-S8 	1.5 gpm (5.7 L/min) (STD)	282.80	Chrome
26C3252 	0.5 gpm (1.9 L/min) (VRS)	282.50	Chrome

- 3-hole 8" installation
- 8" long spout, swings 360°
- Cast body
- Vandal resistant handles
- Red/blue indicators
- 1/2" IPS shanks
- 1.75" max. deck thickness
- CER-TECK® cartridges
- S* = Optional swing spout dimensions:
S3 = 6" Tubular
S7 = 11" Tubular
S8 = 14" Tubular



CER-TECK® 26C3 with 8" Tubular Spout – 3" (76 mm) Hooded Lever Handle

Model	Flow	Price	Finish
26C3223 	1.5 gpm (5.7 L/min) (VRLAM)	280.85	Chrome
26C3223-S8 	1.5 gpm (5.7 L/min) (VRLAM)	297.10	Chrome
26C3233 	1.5 gpm (5.7 L/min) (VR)	282.85	Chrome
26C3233-S7 	1.5 gpm (5.7 L/min) (VR)	280.00	Chrome
26C3233-S8 	1.5 gpm (5.7 L/min) (VR)	285.70	Chrome
26C3233-TI 	1.5 gpm (5.7 L/min) (VR)	282.85	Chrome
26C3243 	1.5 gpm (5.7 L/min) (STD)	270.70	Chrome
26C3243-S3 	1.5 gpm (5.7 L/min) (STD)	270.70	Chrome
26C3243-S7 	1.5 gpm (5.7 L/min) (STD)	275.55	Chrome
26C3243-S8 	1.5 gpm (5.7 L/min) (STD)	281.20	Chrome

- 3-hole 8" installation
- 8" long spout, swings 360°
- Cast body
- Vandal resistant handles
- Red/blue indicators
- 1/2" IPS shanks
- 1.75" max. deck thickness
- CER-TECK® cartridges
- S* = Optional swing spout dimensions:
S3 = 6" Tubular
S7 = 11" Tubular
S8 = 14" Tubular

Sink Faucets



CER-TECK® 26C3 with 8" Tubular Spout – 4" (102 mm) Blade Handle with Sanitary Hood

Model		Flow	Price	Finish
26C3224		1.5 gpm (5.7 L/min) (VRLAM)	304.55	Chrome
26C3234		1.5 gpm (5.7 L/min) (VR)	293.10	Chrome
26C3244		1.5 gpm (5.7 L/min) (STD)	288.60	Chrome
26C3244-S7		1.5 gpm (5.7 L/min) (STD)	315.65	Chrome
26C3244-S8		1.5 gpm (5.7 L/min) (STD)	321.70	Chrome

- 3-hole 8" installation
- 8" long spout, swings 360°
- Cast body
- Vandal resistant handles
- Red/blue indicators
- 1/2" IPS shanks
- 1.75" max. deck thickness
- CER-TECK® cartridges
- S* = Optional swing spout dimensions:
S3 = 6" Tubular
S7 = 11" Tubular
S8 = 14" Tubular



CER-TECK® 26C3 with 8" Tubular Spout – 6" (152 mm) Wrist Handle with Sanitary Hood

Model		Flow	Price	Finish
26C3235		1.5 gpm (5.7 L/min) (VR)	326.25	Chrome

- 3-hole 8" installation
- 8" long spout, swings 360°
- Cast body
- Vandal resistant handles
- Red/blue indicators
- 1/2" IPS shanks
- 1.75" max. deck thickness
- CER-TECK® cartridges



CER-TECK® 26C3 with 6" Gooseneck Spout – 5-Fluted Handle

Model		Flow	Price	Finish
26C3931		1.5 gpm (5.7 L/min) (VR)	302.10	Chrome

- 3-hole 8" installation
- 6" long, 11.6" high spout
- Rigid/swivel gooseneck spout
- Cast body
- Vandal resistant handles
- Red/blue indicators
- 1/2" IPS shanks
- 1.75" max. deck thickness
- CER-TECK® cartridges



CER-TECK® 26C3 with 6" Gooseneck Spout – 4" (102 mm) Hooded Blade Handle

Model		Flow	Price	Finish
26C3922		1.5 gpm (5.7 L/min) (VRLAM)	329.35	Chrome
26C3922-R7		1.5 gpm (5.7 L/min) (VRLAM)	345.75	Chrome
26C3922-TI		1.5 gpm (5.7 L/min) (VRLAM)	329.35	Chrome
26C3932		1.5 gpm (5.7 L/min) (VR)	304.35	Chrome
26C3932-LS-TI		1.5 gpm (5.7 L/min) (VR)	351.90	Chrome
26C3932-R5		1.5 gpm (5.7 L/min) (VR)	312.75	Chrome
26C3932-R7		1.5 gpm (5.7 L/min) (VR)	334.25	Chrome
26C3942		1.5 gpm (5.7 L/min) (STD)	299.90	Chrome
26C3942-R5		1.5 gpm (5.7 L/min) (STD)	308.30	Chrome
26C3942-R6		1.5 gpm (5.7 L/min) (STD)	312.60	Chrome
26C3942-R7		1.5 gpm (5.7 L/min) (STD)	329.75	Chrome
26C3952		0.5 gpm (1.9 L/min) (VRS)	315.90	Chrome
26C3952-R7		0.5 gpm (1.9 L/min) (VRS)	345.75	Chrome

Smooth End Gooseneck

26C3972		1.0 gpm (3.8 L/min) (SELAM)	315.90	Chrome
26C3972-R7		1.0 gpm (3.8 L/min) (SELAM)	345.75	Chrome

- 3-hole 8" installation
- 6" long, 11.6" high spout
- Rigid/swivel gooseneck spout
- Cast body
- Vandal resistant handles
- Red/blue indicators
- 1/2" IPS shanks
- 1.75" max. deck thickness
- CER-TECK® cartridges
- **R*** = Optional gooseneck:
spout dimensions:
R5 = 6" long, 13.2" high
R6 = 6" long, 14.8" high
R7 = 9" long, 13.9" high



CER-TECK® 26C3 with 6" Gooseneck Spout – 3" (76 mm) Hooded Lever Handle

Model		Flow	Price	Finish
26C3923		1.5 gpm (5.7 L/min) (VRLAM)	361.80	Chrome
26C3923-LS-TI		1.5 gpm (5.7 L/min) (VRLAM)	361.80	Chrome
26C3933		1.5 gpm (5.7 L/min) (VR)	302.70	Chrome
26C3933-LS		1.5 gpm (5.7 L/min) (VR)	336.80	Chrome
26C3933-LS-TI		1.5 gpm (5.7 L/min) (VR)	350.25	Chrome
26C3933-R7		1.5 gpm (5.7 L/min) (VR)	332.70	Chrome
26C3943		1.5 gpm (5.7 L/min) (STD)	298.25	Chrome
26C3943-R2		1.5 gpm (5.7 L/min) (STD)	304.90	Chrome
26C3943-R7		1.5 gpm (5.7 L/min) (STD)	328.20	Chrome
26C3953		0.5 gpm (1.9 L/min) (VRS)	314.15	Chrome
26C3953-R7		0.5 gpm (1.9 L/min) (VRS)	344.15	Chrome

Smooth End Gooseneck

26C3973		1.0 gpm (3.8 L/min) (SELAM)	314.15	Chrome
---------	--	-----------------------------	--------	--------

- 3-hole 8" installation
- 6" long, 11.6" high spout
- Rigid/swivel gooseneck spout
- Cast body
- Vandal resistant handles
- Red/blue indicators
- 1/2" IPS shanks
- 1.75" max. deck thickness
- CER-TECK® cartridges
- **R*** = Optional gooseneck:
spout dimensions:
R2 = 4.5" long, 11.7" high
R5 = 6" long, 13.2" high
R6 = 6" long, 14.8" high
R7 = 9" long, 13.9" high



CER-TECK® 26C3 with 6" Gooseneck Spout – 4" (102 mm) Blade Handle with Sanitary Hood

Model		Flow	Price	Finish
26C3924		1.5 gpm (5.7 L/min) (VRLAM)	356.55	Chrome
26C3924-LS		1.5 gpm (5.7 L/min) (VRLAM)	392.45	Chrome
26C3924-R7		1.5 gpm (5.7 L/min) (VRLAM)	367.85	Chrome
26C3924-TI		1.5 gpm (5.7 L/min) (VRLAM)	370.75	Chrome
26C3934		1.5 gpm (5.7 L/min) (VR)	344.45	Chrome
26C3934-LS		1.5 gpm (5.7 L/min) (VR)	380.40	Chrome
26C3934-LS-TI		1.5 gpm (5.7 L/min) (VR)	394.60	Chrome
26C3934-R2		1.5 gpm (5.7 L/min) (VR)	351.40	Chrome
26C3934-R5		1.5 gpm (5.7 L/min) (VR)	353.30	Chrome
26C3934-R7		1.5 gpm (5.7 L/min) (VR)	375.95	Chrome
26C3944		1.5 gpm (5.7 L/min) (STD)	339.70	Chrome
26C3944-LS		1.5 gpm (5.7 L/min) (STD)	356.05	Chrome
26C3944-R2		1.5 gpm (5.7 L/min) (STD)	346.65	Chrome
26C3944-R6		1.5 gpm (5.7 L/min) (STD)	353.10	Chrome
26C3944-R7		1.5 gpm (5.7 L/min) (STD)	351.90	Chrome
26C3944-TI		1.5 gpm (5.7 L/min) (STD)	353.95	Chrome
26C3954		0.5 gpm (1.9 L/min) (VRS)	356.55	Chrome

Smooth End Gooseneck

26C3974		1.0 gpm (3.8 L/min) (SELAM)	337.95	Chrome
26C3974-R7		1.0 gpm (3.8 L/min) (SELAM)	367.85	Chrome

- 3-hole 8" installation
- 6" long, 11.6" high spout
- Rigid/swivel gooseneck spout
- Cast body
- Vandal resistant handles
- Red/blue indicators
- 1/2" IPS shanks
- 1.75" max. deck thickness
- CER-TECK® cartridges
- R* = Optional gooseneck: spout dimensions:
R2 = 4.5" long, 11.7" high
R5 = 6" long, 13.2" high
R6 = 6" long, 14.8" high
R7 = 9" long, 13.9" high



CER-TECK® 26C3 with 6" Gooseneck Spout – 6" (152 mm) Wrist Blade Handle with Sanitary Hood

Model		Flow	Price	Finish
26C3935		1.5 gpm (5.7 L/min) (VR)	379.45	Chrome
26C3945		1.5 gpm (5.7 L/min) (STD)	374.70	Chrome
26C3955-R6		0.5 gpm (1.9 L/min) (VRS)	405.00	Chrome
26C3955-R7		0.5 gpm (1.9 L/min) (VRS)	423.20	Chrome

Smooth End Gooseneck

26C3975-R7		1.0 gpm (3.8 L/min) (SELAM)	423.15	Chrome
------------	--	-----------------------------	--------	--------

- 3-hole 8" installation
- 6" long, 11.6" high spout
- Rigid/swivel gooseneck spout
- Cast body
- Vandal resistant handles
- Red/blue indicators
- 1/2" IPS shanks
- 1.75" max. deck thickness
- CER-TECK® cartridges
- R* = Optional gooseneck: spout dimensions:
R2 = 4.5" long, 11.7" high
R5 = 6" long, 13.2" high
R6 = 6" long, 14.8" high
R7 = 9" long, 13.9" high

MODEL NUMBER EXAMPLE:
Configurations vary, see below for availability.

27C1934

Variation

- 2 = 8" (203 mm) tubular spout
- 9 = 6" (152 mm) gooseneck spout

Outlet

- 3 = Vandal resistant aerator (VR)

Handle

- 3 = Hooded lever
- 4 = Blade w/sanitary hood



CER-TECK® 27C1 with 8" Tubular Spout – 3" (76 mm) Hooded Lever Handle

Model	Flow	Price	Finish
27C1233 	1.5 gpm (5.7 L/min) (VR)	394.90	Chrome

- 4-hole 8" installation
- 8" long spout, swings 360°
- Cast end bodies
- Side spray
- Vandal resistant handles
- Red/blue indicators
- 1/2" IPS shanks
- 1.06" max. deck thickness
- CER-TECK® cartridges



CER-TECK® 27C1 with 8" Tubular Spout – 4" (102 mm) Blade Handle with Sanitary Hood

Model	Flow	Price	Finish
27C1234 	1.5 gpm (5.7 L/min) (VR)	441.60	Chrome

- 4-hole 8" installation
- 8" long spout, swings 360°
- Cast end bodies
- Side spray
- Vandal resistant handles
- Red/blue indicators
- 1/2" IPS shanks
- 1.06" max. deck thickness
- CER-TECK® cartridges



CER-TECK® 27C1 with 6" Gooseneck Spout – 3" (76 mm) Hooded Lever Handle

Model	Flow	Price	Finish
27C1933 	1.5 gpm (5.7 L/min) (VR)	429.45	Chrome

- 4-hole 8" installation
- 6" long, 11.8" high spout
- Rigid/swivel gooseneck spout
- Cast end bodies
- Side spray
- Vandal resistant handles
- Red/blue indicators
- 1/2" IPS shanks
- 1.06" max. deck thickness
- CER-TECK® cartridges



CER-TECK® 27C1 with 6" Gooseneck Spout – 4" (102 mm) Blade Handle with Sanitary Hood

Model	Flow	Price	Finish
27C1934 	1.5 gpm (5.7 L/min) (VR)	453.25	Chrome

- 4-hole 8" installation
- 6" long, 11.8" high spout
- Rigid/swivel gooseneck spout
- Cast end bodies
- Side spray
- Vandal resistant handles
- Red/blue indicators
- 1/2" IPS shanks
- 1.06" max. deck thickness
- CER-TECK® cartridges

MODEL NUMBER EXAMPLE:

Configurations vary, see below for availability.

27C2944-LS

Variation

- 1 = 8" (203 mm) Wallform spout
- 2 = 8" (203 mm) Tubular spout
- 9 = 6" (152 mm) Gooseneck spout

Outlet

- 2 = Vandal resistant laminar outlet (VRLAM)
- 3 = Vandal resistant aerator (VR)
- 4 = Standard aerator outlet (STD)
- 5 = Vandal resistant spray outlet (VRS)
- 7 = Smooth end, laminar outlet (SELAM)

Handle

- 2 = Hooded blade
- 3 = Hooded lever
- 4 = Blade w/sanitary hood
- 5 = Wrist w/sanitary hood

LS = 120° Limited swing gooseneck

TI = Handle temperature indicators
"H" (red), "C" (blue)

R* = Optional gooseneck spout dimensions:
R2 = 4.5" long, 11.9" high
R5 = 6" long, 13.4" high
R6 = 6" long, 15" high
R7 = 9" long, 14.1" high

S* = Optional swing spout dimensions:
S7 = 11" Tubular

CER-TECK® 27C2 with 8" Wallform Spout – 4" (102 mm) Hooded Blade Handle



Model	Flow	Price	Finish
27C2122	1.5 gpm (5.7 L/min) (VRLAM)	338.20	Chrome
27C2142	1.5 gpm (5.7 L/min) (STD)	321.25	Chrome

- 3-hole 8" installation
- 8" long spout, swings 360°
- Cast end bodies
- Vandal resistant handles
- Red/blue indicators
- 1/2" IPS shanks
- 1.06" max. deck thickness
- CER-TECK® cartridges

CER-TECK® 27C2 with 8" Wallform Spout – 3" (76 mm) Hooded Lever Handle



Model	Flow	Price	Finish
27C2123	1.5 gpm (5.7 L/min) (VRLAM)	336.35	Chrome
27C2143	1.5 gpm (5.7 L/min) (STD)	319.60	Chrome

- 3-hole 8" installation
- 8" long spout, swings 360°
- Cast end bodies
- Vandal resistant handles
- Red/blue indicators
- 1/2" IPS shanks
- 1.06" max. deck thickness
- CER-TECK® cartridges

CER-TECK® 27C2 with 8" Wallform Spout – 4" (102 mm) Blade Handle with Sanitary Hood



Model	Flow	Price	Finish
27C2124	1.5 gpm (5.7 L/min) (VRLAM)	361.45	Chrome
27C2144	1.5 gpm (5.7 L/min) (STD)	344.60	Chrome

- 3-hole 8" installation
- 8" long spout, swings 360°
- Cast end bodies
- Vandal resistant handles
- Red/blue indicators
- 1/2" IPS shanks
- 1.06" max. deck thickness
- CER-TECK® cartridges

CER-TECK® 27C2 with 8" Tubular Spout – 4" (102 mm) Hooded Blade Handle



Model	Flow	Price	Finish
27C2222	1.5 gpm (5.7 L/min) (VRLAM)	291.85	Chrome
27C2232	1.5 gpm (5.7 L/min) (VR)	279.75	Chrome
27C2232-S7	1.5 gpm (5.7 L/min) (VR)	290.90	Chrome
27C2242	1.5 gpm (5.7 L/min) (STD)	275.00	Chrome

- 3-hole 8" installation
- 8" long spout, swings 360°
- Cast end bodies
- Vandal resistant handles
- Red/blue indicators
- 1/2" IPS shanks
- 1.06" max. deck thickness
- CER-TECK® cartridges
- S* = Optional swing spout dimensions:**
S7 = 11" Tubular

CER-TECK® 27C2 with 8" Tubular Spout – 3" (76 mm) Hooded Lever Handle



Model	Flow	Price	Finish
27C2233	1.5 gpm (5.7 L/min) (VR)	278.00	Chrome
27C2243	1.5 gpm (5.7 L/min) (STD)	259.05	Chrome
27C2253	0.5 gpm (1.9 L/min) (VRS)	290.10	Chrome

- 3-hole 8" installation
- 8" long spout, swings 360°
- Cast end bodies
- Vandal resistant handles
- Red/blue indicators
- 1/2" IPS shanks
- 1.06" max. deck thickness
- CER-TECK® cartridges



CER-TECK® 27C2 with 8" Tubular Spout – 4" (102 mm) Blade Handle with Sanitary Hood

Model		Flow	Price	Finish
27C2224		1.5 gpm (5.7 L/min) (VRLAM)	298.70	Chrome
27C2234		1.5 gpm (5.7 L/min) (VR)	303.00	Chrome
27C2244		1.5 gpm (5.7 L/min) (STD)	282.70	Chrome

- 3-hole 8" installation
- 8" long spout, swings 360°
- Cast end bodies
- Vandal resistant handles
- Red/blue indicators
- 1/2" IPS shanks
- 1.06" max. deck thickness
- CER-TECK® cartridges



CER-TECK® 27C2 with 8" Tubular Spout – 6" (152 mm) Wrist Handle with Sanitary Hood

Model		Flow	Price	Finish
27C2245		1.5 gpm (5.7 L/min) (STD)	333.40	Chrome

- 3-hole 8" installation
- 8" long spout, swings 360°
- Cast end bodies
- Vandal resistant handles
- Red/blue indicators
- 1/2" IPS shanks
- 1.06" max. deck thickness
- CER-TECK® cartridges



CER-TECK® 27C2 with 6" Gooseneck Spout – 4" (102 mm) Hooded Blade Handle

Model		Flow	Price	Finish
27C2922		1.5 gpm (5.7 L/min) (VRLAM)	328.35	Chrome
27C2922-R7		1.5 gpm (5.7 L/min) (VRLAM)	360.00	Chrome
27C2932		1.5 gpm (5.7 L/min) (VR)	316.20	Chrome
27C2932-R7		1.5 gpm (5.7 L/min) (VR)	347.75	Chrome
27C2942		1.5 gpm (5.7 L/min) (STD)	311.55	Chrome
27C2942-LS		1.5 gpm (5.7 L/min) (STD)	347.50	Chrome
27C2942-R5		1.5 gpm (5.7 L/min) (STD)	320.40	Chrome
27C2942-R7		1.5 gpm (5.7 L/min) (STD)	343.05	Chrome
27C2952		0.5 gpm (1.9 L/min) (VRS)	360.00	Chrome
27C2952-R7		0.5 gpm (1.9 L/min) (VRS)	360.00	Chrome

- 3-hole 8" installation
- 6" long spout, 11.8" high spout
- Cast end bodies
- Vandal resistant handles
- Red/blue indicators
- 1/2" IPS shanks
- 1.06" max. deck thickness
- CER-TECK® cartridges
- R* = Optional gooseneck spout dimensions:
R2 = 4.5" long, 11.9" high
R5 = 6" long, 13.4" high
R6 = 6" long, 15" high
R7 = 9" long, 14.1" high

Smooth End Gooseneck

27C2972		1.0 gpm (3.8 L/min) (SELAM)	328.35	Chrome
27C2972-R7		1.0 gpm (3.8 L/min) (SELAM)	360.00	Chrome



CER-TECK® 27C2 with 6" Gooseneck Spout – 3" (76 mm) Hooded Lever Handle

Model		Flow	Price	Finish
27C2923		1.5 gpm (5.7 L/min) (VRLAM)	326.65	Chrome
27C2933		1.5 gpm (5.7 L/min) (VR)	314.45	Chrome
27C2933-LS		1.5 gpm (5.7 L/min) (VR)	350.40	Chrome
27C2933-R7		1.5 gpm (5.7 L/min) (VR)	346.10	Chrome
27C2943		1.5 gpm (5.7 L/min) (STD)	309.70	Chrome
27C2943-R7		1.5 gpm (5.7 L/min) (STD)	341.35	Chrome

- 3-hole 8" installation
- 6" long spout, 11.8" high spout
- Cast end bodies
- Vandal resistant handles
- Red/blue indicators
- 1/2" IPS shanks
- 1.06" max. deck thickness
- CER-TECK® cartridges
- R* = Optional gooseneck spout dimensions:
R2 = 4.5" long, 11.9" high
R5 = 6" long, 13.4" high
R6 = 6" long, 15" high
R7 = 9" long, 14.1" high

Smooth End Gooseneck

27C2973		1.0 gpm (3.8 L/min) (SELAM)	326.65	Chrome
---------	--	-----------------------------	--------	--------



CER-TECK® 27C2 with 6" Gooseneck Spout – 4" (102 mm) Blade Handle with Sanitary Hood

Model		Flow	Price	Finish
27C2924		1.5 gpm (5.7 L/min) (VRLAM)	401.85	Chrome
27C2924-LS-TI		1.5 gpm (5.7 L/min) (VRLAM)	401.85	Chrome
27C2924-R5		1.5 gpm (5.7 L/min) (VRLAM)	360.50	Chrome
27C2924-R7		1.5 gpm (5.7 L/min) (VRLAM)	383.25	Chrome
27C2924-TI		1.5 gpm (5.7 L/min) (VRLAM)	365.85	Chrome
27C2934		1.5 gpm (5.7 L/min) (VR)	346.50	Chrome
27C2934-LS		1.5 gpm (5.7 L/min) (VR)	375.50	Chrome
27C2934-R2		1.5 gpm (5.7 L/min) (VR)	346.50	Chrome
27C2934-R7		1.5 gpm (5.7 L/min) (VR)	371.10	Chrome
27C2944		1.5 gpm (5.7 L/min) (STD)	334.85	Chrome
27C2944-LS		1.5 gpm (5.7 L/min) (STD)	370.75	Chrome
27C2944-LS-TI		1.5 gpm (5.7 L/min) (STD)	385.00	Chrome
27C2944-R7		1.5 gpm (5.7 L/min) (STD)	366.40	Chrome
27C2954		0.5 gpm (1.9 L/min) (VRS)	351.60	Chrome
27C2954-R7		0.5 gpm (1.9 L/min) (VRS)	383.25	Chrome

Smooth End Gooseneck

27C2974		1.0 gpm (3.8 L/min) (SELAM)	365.85	Chrome
27C2974-R7		1.0 gpm (3.8 L/min) (SELAM)	383.25	Chrome
27C2974-TI		1.0 gpm (3.8 L/min) (SELAM)	365.85	Chrome

- 3-hole 8" installation
- 6" long spout, 11.8" high spout
- Cast end bodies
- Vandal resistant handles
- Red/blue indicators
- 1/2" IPS shanks
- 1.06" max. deck thickness
- CER-TECK® cartridges
- R* = Optional gooseneck spout dimensions:
R2 = 4.5" long, 11.9" high
R5 = 6" long, 13.4" high
R6 = 6" long, 15" high
R7 = 9" long, 14.1" high



CER-TECK® 27C2 with 6" Gooseneck Spout – 6" (152 mm) Wrist Handle with Sanitary Hood

Model		Flow	Price	Finish
27C2935		1.5 gpm (5.7 L/min) (VR)	374.55	Chrome
27C2945-R7		1.5 gpm (5.7 L/min) (STD)	401.40	Chrome
27C2955		0.5 gpm (1.9 L/min) (VRS)	386.75	Chrome

Smooth End Gooseneck

27C2975		1.0 gpm (3.8 L/min) (SELAM)	386.75	Chrome
---------	--	-----------------------------	--------	--------

- 3-hole 8" installation
- 6" long spout, 11.8" high spout
- Cast end bodies
- Vandal resistant handles
- Red/blue indicators
- 1/2" IPS shanks
- 1.06" max. deck thickness
- CER-TECK® cartridges
- R* = Optional gooseneck spout dimensions:
R2 = 4.5" long, 11.9" high
R5 = 6" long, 13.4" high
R6 = 6" long, 15" high
R7 = 9" long, 14.1" high

MODEL NUMBER EXAMPLE:
Configurations vary, see below for availability.

27C4 9 4 4 - TI

Variation

- 2 = 8" (203 mm) Tubular spout
- 3 = 6" (152 mm) Tubular spout
- 8 = 4.5" (114 mm) Gooseneck spout
- 9 = 6" (152 mm) Gooseneck spout

Outlet

- 2 = Vandal resistant laminar outlet (VRLAM)
- 3 = Vandal resistant aerator (VR)
- 4 = Standard aerator outlet (STD)
- 5 = Vandal resistant spray outlet (VRS)
- 7 = Smooth end, laminar outlet (SELAM)

Handle

- 2 = Hooded blade
- 3 = Hooded lever
- 4 = Blade w/sanitary hood
- 5 = Wrist w/sanitary hood

- LS = 120° Limited swing gooseneck
- TI = Handle temperature indicators
"H" (red), "C" (blue)
- R* = Optional gooseneck spout dimensions:
R5 = 6" long, 13.25" high
R6 = 6" long, 14.9" high
R7 = 9" long, 14" high
- S* = Optional swing spout dimensions:
S7 = 11" Tubular
S8 = 14" Tubular

CER-TECK® 27C4 with 8" Tubular Spout – 4" (102 mm) Hooded Blade Handle



Model	Flow	Price	Finish
27C4222	1.5 gpm (5.7 L/min) (VRLAM)	220.45	Chrome
27C4232	1.5 gpm (5.7 L/min) (VR)	197.45	Chrome
27C4242	1.5 gpm (5.7 L/min) (STD)	193.05	Chrome

- 2-hole 4" installation
- 8" long spout, swings 360°
- Cast body
- Vandal resistant handles
- Red/blue indicators
- 1/2" IPS shanks
- 1.75" max. deck thickness
- CER-TECK® cartridges
- S* = Optional swing spout dimensions:
S7 = 11" Tubular
S8 = 14" Tubular

CER-TECK® 27C4 with 8" Tubular Spout – 3" (76 mm) Hooded Lever Handle



Model	Flow	Price	Finish
27C4223	1.5 gpm (5.7 L/min) (VRLAM)	207.30	Chrome
27C4233	1.5 gpm (5.7 L/min) (VR)	195.80	Chrome
27C4243	1.5 gpm (5.7 L/min) (STD)	191.30	Chrome
27C4243-S8	1.5 gpm (5.7 L/min) (STD)	219.05	Chrome
27C4253	0.5 gpm (1.9 L/min) (VRS)	207.30	Chrome

- 2-hole 4" installation
- 8" long spout, swings 360°
- Cast body
- Vandal resistant handles
- Red/blue indicators
- 1/2" IPS shanks
- 1.75" max. deck thickness
- CER-TECK® cartridges
- S* = Optional swing spout dimensions:
S7 = 11" Tubular
S8 = 14" Tubular

CER-TECK® 27C4 with 8" Tubular Spout – 4" (102 mm) Blade Handle with Sanitary Hood



Model	Flow	Price	Finish
27C4224	1.5 gpm (5.7 L/min) (VRLAM)	221.05	Chrome
27C4234	1.5 gpm (5.7 L/min) (VR)	231.65	Chrome
27C4244	1.5 gpm (5.7 L/min) (STD)	226.95	Chrome
27C4254	0.5 gpm (1.9 L/min) (VRS)	243.75	Chrome

- 2-hole 4" installation
- 8" long spout, swings 360°
- Cast body
- Vandal resistant handles
- Red/blue indicators
- 1/2" IPS shanks
- 1.75" max. deck thickness
- CER-TECK® cartridges
- S* = Optional swing spout dimensions:
S7 = 11" Tubular
S8 = 14" Tubular

CER-TECK® 27C4 with 8" Tubular Spout – 6" (152 mm) Wrist Handle with Sanitary Hood



Model	Flow	Price	Finish
27C4235	1.5 gpm (5.7 L/min) (VR)	266.70	Chrome

- 2-hole 4" installation
- 8" long spout, swings 360°
- Cast body
- Vandal resistant handles
- Red/blue indicators
- 1/2" IPS shanks
- 1.75" max. deck thickness
- CER-TECK® cartridges



CER-TECK® 27C4 with 6" Tubular Spout – 4" (102 mm) Hooded Blade Handle

Model	Flow	Price	Finish
27C4332	1.5 gpm (5.7 L/min) (VR)	197.45	Chrome
27C4342	1.5 gpm (5.7 L/min) (STD)	193.05	Chrome

- 2-hole 4" installation
- 6" long spout, swings 360°
- Cast body
- Vandal resistant handles
- Red/blue indicators
- 1/2" IPS shanks
- 1.75" max. deck thickness
- CER-TECK® cartridges



CER-TECK® 27C4 with 6" Tubular Spout – 3" (76 mm) Hooded Lever Handle

Model	Flow	Price	Finish
27C4323	1.5 gpm (5.7 L/min) (VRLAM)	207.30	Chrome
27C4333	1.5 gpm (5.7 L/min) (VR)	195.80	Chrome
27C4343	1.5 gpm (5.7 L/min) (STD)	191.30	Chrome
27C4353	0.5 gpm (1.9 L/min) (VRS)	207.30	Chrome

- 2-hole 4" installation
- 6" long spout, swings 360°
- Cast body
- Vandal resistant handles
- Red/blue indicators
- 1/2" IPS shanks
- 1.75" max. deck thickness
- CER-TECK® cartridges



CER-TECK® 27C4 with 6" Tubular Spout – 4" (102 mm) Blade Handle with Sanitary Hood

Model	Flow	Price	Finish
27C4324	1.5 gpm (5.7 L/min) (VRLAM)	243.75	Chrome
27C4344	1.5 gpm (5.7 L/min) (STD)	226.95	Chrome

- 2-hole 4" installation
- 6" long spout, swings 360°
- Cast body
- Vandal resistant handles
- Red/blue indicators
- 1/2" IPS shanks
- 1.75" max. deck thickness
- CER-TECK® cartridges



CER-TECK® 27C4 with 4.5" Gooseneck Spout – 4" (102 mm) Hooded Blade Handle

Model	Flow	Price	Finish
27C4822	1.5 gpm (5.7 L/min) (VRLAM)	271.95	Chrome
27C4832	1.5 gpm (5.7 L/min) (VR)	259.80	Chrome
27C4842	1.5 gpm (5.7 L/min) (STD)	255.10	Chrome
27C4852	0.5 gpm (1.9 L/min) (VRS)	271.95	Chrome

- 2-hole 4" installation
- 4.5" long, 11.75" high spout
- Rigid/swivel gooseneck spout
- Cast body
- Vandal resistant handles
- Red/blue indicators
- 1/2" IPS shanks
- 1.75" max. deck thickness
- CER-TECK® cartridges

Smooth End Gooseneck

27C4872	1.0 gpm (3.8 L/min) (SELAM)	257.70	Chrome
---------	-----------------------------	--------	--------



CER-TECK® 27C4 with 4.5" Gooseneck Spout – 3" (76 mm) Hooded Lever Handle

Model		Flow	Price	Finish
27C4823		1.5 gpm (5.7 L/min) (VRLAM)	270.25	Chrome
27C4833		1.5 gpm (5.7 L/min) (VR)	258.15	Chrome
27C4843		1.5 gpm (5.7 L/min) (STD)	253.40	Chrome
27C4853		0.5 gpm (1.9 L/min) (VRS)	270.25	Chrome

- 2-hole 4" installation
- 4.5" long, 11.75" high spout
- Rigid/swivel gooseneck spout
- Cast body
- Vandal resistant handles
- Red/blue indicators
- 1/2" IPS shanks
- 1.75" max. deck thickness
- CER-TECK® cartridges

Smooth End Gooseneck

27C4873		1.0 gpm (3.8 L/min) (SELAM)	256.15	Chrome
---------	--	-----------------------------	--------	--------



CER-TECK® 27C4 with 4.5" Gooseneck Spout – 4" (102 mm) Blade Handle with Sanitary Hood

Model		Flow	Price	Finish
27C4824		1.5 gpm (5.7 L/min) (VRLAM)	295.25	Chrome
27C4834		1.5 gpm (5.7 L/min) (VR)	283.10	Chrome
27C4834-TI		1.5 gpm (5.7 L/min) (VR)	297.35	Chrome
27C4844		1.5 gpm (5.7 L/min) (STD)	278.45	Chrome
27C4844-TI		1.5 gpm (5.7 L/min) (STD)	292.60	Chrome
27C4854		0.5 gpm (1.9 L/min) (VRS)	295.25	Chrome

- 2-hole 4" installation
- 4.5" long, 11.75" high spout
- Rigid/swivel gooseneck spout
- Cast body
- Vandal resistant handles
- Red/blue indicators
- 1/2" IPS shanks
- 1.75" max. deck thickness
- CER-TECK® cartridges

Smooth End Gooseneck

27C4874		1.0 gpm (3.8 L/min) (SELAM)	295.25	Chrome
27C4874-TI		1.0 gpm (3.8 L/min) (SELAM)	309.45	Chrome



CER-TECK® 27C4 with 4.5" Gooseneck Spout – 6" (152 mm) Wrist Handle with Sanitary Hood

Model		Flow	Price	Finish
27C4835		1.5 gpm (5.7 L/min) (VR)	318.20	Chrome
27C4845		1.5 gpm (5.7 L/min) (STD)	313.45	Chrome

- 2-hole 4" installation
- 4.5" long, 11.75" high spout
- Rigid/swivel gooseneck spout
- Cast body
- Vandal resistant handles
- Red/blue indicators
- 1/2" IPS shanks
- 1.75" max. deck thickness
- CER-TECK® cartridges



CER-TECK® 27C4 with 6" Gooseneck Spout – 4" (102 mm) Hooded Blade Handle

Model	Flow	Price	Finish
27C4922	1.5 gpm (5.7 L/min) (VRLAM)	271.95	Chrome
27C4922-R7	1.5 gpm (5.7 L/min) (VRLAM)	303.50	Chrome
27C4932	1.5 gpm (5.7 L/min) (VR)	259.80	Chrome
27C4932-R7	1.5 gpm (5.7 L/min) (VR)	291.35	Chrome
27C4942	1.5 gpm (5.7 L/min) (STD)	255.10	Chrome
27C4942-LS	1.5 gpm (5.7 L/min) (STD)	291.10	Chrome
27C4942-R6	1.5 gpm (5.7 L/min) (STD)	268.50	Chrome
27C4952	0.5 gpm (1.9 L/min) (VRS)	271.95	Chrome

Smooth End Gooseneck

27C4972	1.0 gpm (3.8 L/min) (SELAM)	257.70	Chrome
---------	-----------------------------	--------	--------

- 2-hole 4" installation
- 6" long, 11.7" high
- Rigid/swivel gooseneck spout
- Cast body
- Vandal resistant handles
- Red/blue indicators
- 1/2" IPS shanks
- 1.75" max. deck thickness
- CER-TECK® cartridges
- R* = Optional gooseneck spout dimensions:
 R5 = 6" long, 13.25" high
 R6 = 6" long, 14.9" high
 R7 = 9" long, 14" high



CER-TECK® 27C4 with 6" Gooseneck Spout – 3" (76 mm) Hooded Lever Handle

Model	Flow	Price	Finish
27C4923	1.5 gpm (5.7 L/min) (VRLAM)	270.25	Chrome
27C4933	1.5 gpm (5.7 L/min) (VR)	258.15	Chrome
27C4933-LS	1.5 gpm (5.7 L/min) (VR)	294.05	Chrome
27C4943	1.5 gpm (5.7 L/min) (STD)	253.40	Chrome
27C4943-R7	1.5 gpm (5.7 L/min) (STD)	285.00	Chrome
27C4953	0.5 gpm (1.9 L/min) (VRS)	270.25	Chrome

- 2-hole 4" installation
- 6" long, 11.7" high spout
- Rigid/swivel gooseneck spout
- Cast body
- Vandal resistant handles
- Red/blue indicators
- 1/2" IPS shanks
- 1.75" max. deck thickness
- CER-TECK® cartridges
- R* = Optional gooseneck spout dimensions:
 R5 = 6" long, 13.25" high
 R6 = 6" long, 14.9" high
 R7 = 9" long, 14" high



CER-TECK® 27C4 with 6" Gooseneck Spout – 4" (102 mm) Blade Handle with Sanitary Hood

Model	Flow	Price	Finish
27C4924	1.5 gpm (5.7 L/min) (VRLAM)	295.25	Chrome
27C4924-LS	1.5 gpm (5.7 L/min) (VRLAM)	331.20	Chrome
27C4924-R5	1.5 gpm (5.7 L/min) (VRLAM)	304.15	Chrome
27C4924-R7	1.5 gpm (5.7 L/min) (VRLAM)	326.90	Chrome
27C4924-TI	1.5 gpm (5.7 L/min) (VRLAM)	309.45	Chrome
27C4934	1.5 gpm (5.7 L/min) (VR)	319.10	Chrome
27C4934-LS	1.5 gpm (5.7 L/min) (VR)	333.35	Chrome
27C4934-LS-TI	1.5 gpm (5.7 L/min) (VR)	333.35	Chrome
27C4934-R7	1.5 gpm (5.7 L/min) (VR)	314.65	Chrome
27C4934-TI	1.5 gpm (5.7 L/min) (VR)	295.20	Chrome
27C4944	1.5 gpm (5.7 L/min) (STD)	328.55	Chrome
27C4944-LS	1.5 gpm (5.7 L/min) (STD)	328.55	Chrome
27C4944-LS-TI	1.5 gpm (5.7 L/min) (STD)	328.55	Chrome
27C4944-R5	1.5 gpm (5.7 L/min) (STD)	287.35	Chrome
27C4944-R7	1.5 gpm (5.7 L/min) (STD)	310.00	Chrome
27C4944-TI	1.5 gpm (5.7 L/min) (STD)	292.60	Chrome
27C4954	0.5 gpm (1.9 L/min) (VRS)	295.25	Chrome
27C4954-LS-TI	0.5 gpm (1.9 L/min) (VRS)	345.40	Chrome

Smooth End Gooseneck

27C4974	1.0 gpm (3.8 L/min) (SELAM)	326.90	Chrome
27C4974-R7	1.0 gpm (3.8 L/min) (SELAM)	326.90	Chrome
27C4974-TI	1.0 gpm (3.8 L/min) (SELAM)	309.45	Chrome

- 2-hole 4" installation
- 6" long, 11.7" high spout
- Rigid/swivel gooseneck spout
- Cast body
- Vandal resistant handles
- Red/blue indicators
- 1/2" IPS shanks
- 1.75" max. deck thickness
- CER-TECK® cartridges
- **R*** = Optional gooseneck spout dimensions:
 R5 = 6" long, 13.25" high
 R6 = 6" long, 14.9" high
 R7 = 9" long, 14" high



CER-TECK® 27C4 with 6" Gooseneck Spout – 6" (152 mm) Wrist Handle with Sanitary Hood

Model	Flow	Price	Finish
27C4925	1.5 gpm (5.7 L/min) (VRLAM)	330.25	Chrome
27C4925-R7	1.5 gpm (5.7 L/min) (VRLAM)	361.90	Chrome
27C4955	0.5 gpm (1.9 L/min) (VRS)	330.25	Chrome

Smooth End Gooseneck

27C4975	1.0 gpm (3.8 L/min) (SELAM)	314.50	Chrome
---------	-----------------------------	--------	--------

- 2-hole 4" installation
- 6" long, 11.7" high spout
- Rigid/swivel gooseneck spout
- Cast body
- Vandal resistant handles
- Red/blue indicators
- 1/2" IPS shanks
- 1.75" max. deck thickness
- CER-TECK® cartridges
- **R*** = Optional gooseneck spout dimensions:
 R5 = 6" long, 13.25" high
 R6 = 6" long, 14.9" high
 R7 = 9" long, 14" high

MODEL NUMBER EXAMPLE:
Configurations vary, see below for availability.

27C633

6 = Gooseneck spout

Outlet
3 = Vandal resistant aerator (VR)
4 = Standard aerator outlet (STD)
5 = Vandal resistant spray outlet (VRS)

Handle
3 = Hooded lever
8 = Self-closing hooded lever



CER-TECK® 27C6 with 4.5" Gooseneck Spout – 3" (76 mm) Hooded Lever Handle

Model	Flow	Price	Finish
27C633	1.5 gpm (5.7 L/min) (VR)	233.25	Chrome
27C643	1.5 gpm (5.7 L/min) (STD)	228.50	Chrome
27C653	0.5 gpm (1.9 L/min) (VRS)	245.40	Chrome

Self-Closing Handle

27C638	1.5 gpm (5.7 L/min) (VR)	252.65	Chrome
27C648	1.5 gpm (5.7 L/min) (STD)	247.95	Chrome

- 1-hole installation
- Cast body
- 4.5" long, 14.5" high
- Rigid/swivel gooseneck spout
- Vandal resistant ADA handle
- Red/blue indicators
- 1.25" max. deck thickness
- CER-TECK® cartridges

MODEL NUMBER EXAMPLE:
Configurations vary, see below for availability.

28C2383-AC

Variation

- 0 = 5.5" (140 mm) plain spout*
- 3 = 10.5" (267 mm) spout with top/bottom brace*

Outlet

- 6 = Spout end vacuum breaker
- 8 = Body mounted vacuum breaker

Handle

- 3 = Hooded lever
- 4 = Blade w/sanitary hood
- 5 = Wrist w/sanitary hood

AC = 5.5" to 10.5" adjustable centers

*Distance from wall to spout outlet with spout end vacuum breaker



CER-TECK® 28C2 with 5.5" Plain Spout* – 3" (76 mm) Hooded Lever Handle

Model	Flow	Price	Finish
Spout End Vacuum Breaker			
28C2063	4.0 gpm (15.1 L/min)	436.95	Chrome
Body Mounted Vacuum Breaker			
28C2083	4.0 gpm (15.1 L/min)	448.35	Chrome

- Wall installation - 8" centers
- Integral check stops
- Cast body
- Vandal resistant handles
- Red/blue indicators
- Plain spout
- Pail hook
- Garden hose end outlet
- CER-TECK® cartridges
- Not for potable water



CER-TECK® 28C2 with 10.5" Spout with Top/Bottom Brace* – 3" (76 mm) Hooded Lever Handle

Model	Flow	Price	Finish
Spout End Vacuum Breaker			
28C2363	4.0 gpm (15.1 L/min)	461.20	Chrome
Body Mounted Vacuum Breaker			
28C2383	4.0 gpm (15.1 L/min)	472.50	Chrome
28C2383-AC	4.0 gpm (15.1 L/min)	567.25	Chrome

- Wall installation - 8" centers
- Integral check stops
- Cast body
- Vandal resistant handles
- Red/blue indicators
- Spout with top/bottom brace
- Pail hook
- Garden hose end outlet
- CER-TECK® cartridges
- Not for potable water



CER-TECK® 28C2 with 10.5" Spout with Top/Bottom Brace* – 4" (102 mm) Blade Handle with Sanitary Hood

Model	Flow	Price	Finish
Spout End Vacuum Breaker			
28C2364	4.0 gpm (15.1 L/min)	486.70	Chrome
Body Mounted Vacuum Breaker			
28C2384	4.0 gpm (15.1 L/min)	497.95	Chrome
28C2384-AC	4.0 gpm (15.1 L/min)	592.70	Chrome

- Wall installation - 8" centers
- Integral check stops
- Cast body
- Vandal resistant handles
- Red/blue indicators
- Spout with top/bottom brace
- Pail hook
- Garden hose end outlet
- CER-TECK® cartridges
- Not for potable water



CER-TECK® 28C2 with 10.5" Spout with Top/Bottom Brace* – 6" (152 mm) Wrist Handle with Sanitary Hood

Model	Flow	Price	Finish
Body Mounted Vacuum Breaker			
28C2385	4.0 gpm (15.1 L/min)	533.75	Chrome

- Wall installation - 8" centers
- Integral check stops
- Cast body
- Vandal resistant handles
- Red/blue indicators
- Spout with top/bottom brace
- Pail hook
- Garden hose end outlet
- CER-TECK® cartridges
- Not for potable water

*Distance from wall to spout outlet with spout end vacuum breaker.

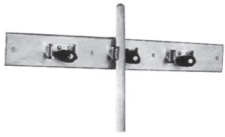

Mop Holder for 28C Wallmount Service Sink Faucets

- Stainless steel mop holder
- 3 spring loaded rubber grip holders

Model	Flow	Price	Finish
28T910	N/A	82.05	Stainless Steel



48" Hose and Hanger for 28C Wallmount Service Sink Faucets

- 48" hose and stainless steel hanger

Model	Flow	Price	Finish
28T911	N/A	45.60	Stainless Steel

MODEL NUMBER EXAMPLE:
Configurations vary, see below for availability.

28C4 4 4 3 - AC

Variation

- 2 = 8" (203 mm) tubular spout
- 4 = 11" (279 mm) tubular spout
- 9 = 6" (152 mm) gooseneck spout

Outlet

- 2 = Vandal resistant laminar outlet (VRLAM)
- 3 = Vandal resistant aerator (VR)
- 4 = Standard aerator outlet (STD)

Handle

- 3 = Hooded lever
- 4 = Blade w/sanitary hood

AC = 5.5" to 10.5" adjustable centers

R* = Optional gooseneck spout dimensions:
R2 = 4.5" long
R7 = 9" long

S* = Optional swing spout dimensions:
S3 = 6" Tubular
S8 = 14" Tubular



CER-TECK® 28C4 with 8" Tubular Spout – 3" (76 mm) Hooded Lever Handle

Model		Flow	Price	Finish
28C4233		1.5 gpm (5.7 L/min) (VRLAM)	332.70	Chrome
28C4233-S8		1.5 gpm (5.7 L/min) (VRLAM)	350.25	Chrome
28C4243		1.5 gpm (5.7 L/min) (STD)	328.05	Chrome
28C4243-AC		1.5 gpm (5.7 L/min) (STD)	422.80	Chrome
28C4243-S8		1.5 gpm (5.7 L/min) (STD)	345.45	Chrome

- Wall installation - 8" centers
- 8" long spout, swings 360°
- Cast body
- Vandal resistant handles
- Red/blue indicators
- LESS Integral Stops
- CER-TECK® cartridges
- For commercial use only
- **S*** = Optional swing spout dimensions:
S3 = 6" Tubular
S8 = 14" Tubular



CER-TECK® 28C4 with 8" Tubular Spout – 4" (102 mm) Blade Handle with Sanitary Hood

Model		Flow	Price	Finish
28C4224		1.5 gpm (5.7 L/min) (VRLAM)	370.65	Chrome
28C4234		1.5 gpm (5.7 L/min) (VR)	358.30	Chrome
28C4244		1.5 gpm (5.7 L/min) (STD)	353.55	Chrome

- Wall installation - 8" centers
- 8" long spout, swings 360°
- Cast body
- Vandal resistant handles
- Red/blue indicators
- LESS Integral Stops
- CER-TECK® cartridges
- For commercial use only



CER-TECK® 28C4 with 11" Tubular Spout – 3" (76 mm) Hooded Lever Handle

Model		Flow	Price	Finish
28C4423		1.5 gpm (5.7 L/min) (VRLAM)	350.95	Chrome
28C4433		1.5 gpm (5.7 L/min) (VR)	338.55	Chrome
28C4443		1.5 gpm (5.7 L/min) (STD)	333.70	Chrome
28C4443-AC		1.5 gpm (5.7 L/min) (STD)	428.55	Chrome

- Wall installation - 8" centers
- 11" long spout, swings 360°
- Cast body
- Vandal resistant handles
- Red/blue indicators
- LESS Integral Stops
- CER-TECK® cartridges
- For commercial use only



CER-TECK® 28C4 with 11" Tubular Spout – 4" (102 mm) Blade Handle with Sanitary Hood

Model		Flow	Price	Finish
28C4424		1.5 gpm (5.7 L/min) (VRLAM)	376.40	Chrome
28C4434		1.5 gpm (5.7 L/min) (VR)	364.05	Chrome
28C4444		1.5 gpm (5.7 L/min) (STD)	359.25	Chrome

- Wall installation - 8" centers
- 11" long spout, swings 360°
- Cast body
- Vandal resistant handles
- Red/blue indicators
- LESS Integral Stops
- CER-TECK® cartridges
- For commercial use only



CER-TECK® 28C4 with 6" Gooseneck Spout – 3" (76 mm) Hooded Lever Handle

Model		Flow	Price	Finish
28C4933		1.5 gpm (5.7 L/min) (VR)	369.50	Chrome
28C4933-R7		1.5 gpm (5.7 L/min) (VR)	401.60	Chrome
28C4943		1.5 gpm (5.7 L/min) (STD)	364.70	Chrome
28C4943-R2		1.5 gpm (5.7 L/min) (STD)	371.85	Chrome

- Wall installation – 8" centers
- 6" long spout, swings 360°
- Cast body
- Vandal resistant handles
- Red/blue indicators
- LESS Integral Stops
- CER-TECK® cartridges
- For commercial use only
- **R*** = Optional gooseneck spout dimensions:
R2 = 4.5" long
R7 = 9" long



CER-TECK® 28C4 with 6" Gooseneck Spout – 4" (102 mm) Blade Handle with Sanitary Hood

Model		Flow	Price	Finish
28C4924		1.5 gpm (5.7 L/min) (VRLAM)	407.35	Chrome
28C4934		1.5 gpm (5.7 L/min) (VR)	496.85	Chrome
28C4934-AC-R2		1.5 gpm (5.7 L/min) (VR)	496.85	Chrome
28C4934-R7		1.5 gpm (5.7 L/min) (VR)	427.10	Chrome
28C4944		1.5 gpm (5.7 L/min) (STD)	390.20	Chrome

- Wall installation – 8" centers
- 6" long spout, swings 360°
- Cast body
- Vandal resistant handles
- Red/blue indicators
- LESS Integral Stops
- CER-TECK® cartridges
- For commercial use only
- **R*** = Optional gooseneck spout dimensions:
R2 = 4.5" long
R7 = 9" long

MODEL NUMBER EXAMPLE:
Configurations vary, see below for availability.

28C6933-AC

Variation

- 2 = 8" (203 mm) tubular spout
- 4 = 11" (279 mm) tubular spout
- 9 = 6" (152 mm) gooseneck spout

Outlet

- 2 = Vandal resistant laminar outlet (VRLAM)
- 3 = Vandal resistant aerator (VR)
- 4 = Standard aerator outlet (STD)

Handle

- 3 = Hooded lever
- 4 = Blade w/sanitary hood

- AC** = 5.5" to 10.5" adjustable centers
- R*** = Optional gooseneck spout dimensions:
R7 = 9" long
- S*** = Optional swing spout dimensions:
S8 = 14" tubular



CER-TECK® 28C6 with 8" Tubular Spout – 3" (76 mm) Hooded Lever Handle

Model		Flow	Price	Finish
28C6223		1.5 gpm (5.7 L/min) (VRLAM)	383.15	Chrome
28C6233		1.5 gpm (5.7 L/min) (VR)	370.75	Chrome
28C6243		1.5 gpm (5.7 L/min) (STD)	366.00	Chrome

- Wall installation - 8" centers
- 8" long spout, swings 360°
- Cast body
- Vandal resistant handles
- Red/blue indicators
- WITH integral check stops
- CER-TECK® cartridges
- For commercial use only



CER-TECK® 28C6 with 8" Tubular Spout – 4" (102 mm) Blade Handle with Sanitary Hood

Model		Flow	Price	Finish
28C6224		1.5 gpm (5.7 L/min) (VRLAM)	426.10	Chrome
28C6224-S8		1.5 gpm (5.7 L/min) (VRLAM)	426.10	Chrome
28C6234		1.5 gpm (5.7 L/min) (VR)	396.30	Chrome
28C6244		1.5 gpm (5.7 L/min) (STD)	391.50	Chrome

- Wall installation - 8" centers
- 8" long spout, swings 360°
- Cast body
- Vandal resistant handles
- Red/blue indicators
- WITH integral check stops
- CER-TECK® cartridges
- For commercial use only
- **S*** = Optional swing spout dimensions:
S8 = 14" tubular



CER-TECK® 28C6 with 11" Tubular Spout – 3" (76 mm) Hooded Lever Handle

Model		Flow	Price	Finish
28C6423		1.5 gpm (5.7 L/min) (VRLAM)	352.70	Chrome
28C6433		1.5 gpm (5.7 L/min) (VR)	376.60	Chrome
28C6443		1.5 gpm (5.7 L/min) (STD)	371.75	Chrome

- Wall installation - 8" centers
- 11" long spout, swings 360°
- Cast body
- Vandal resistant handles
- Red/blue indicators
- WITH integral check stops
- CER-TECK® cartridges
- For commercial use only



CER-TECK® 28C6 with 11" Tubular Spout – 4" (102 mm) Blade Handle with Sanitary Hood

Model		Flow	Price	Finish
28C6424		1.5 gpm (5.7 L/min) (VRLAM)	414.40	Chrome
28C6434		1.5 gpm (5.7 L/min) (VR)	402.10	Chrome
28C6444		1.5 gpm (5.7 L/min) (STD)	397.30	Chrome

- Wall installation - 8" centers
- 11" long spout, swings 360°
- Cast body
- Vandal resistant handles
- Red/blue indicators
- WITH integral check stops
- CER-TECK® cartridges
- For commercial use only

Sink Faucets



CER-TECK® 28C6 with 6" Gooseneck Spout – 3" (76 mm) Hooded Lever Handle

Model		Flow	Price	Finish
28C6933		1.5 gpm (5.7 L/min) (VR)	407.45	Chrome
28C6933-AC		1.5 gpm (5.7 L/min) (VR)	502.30	Chrome
28C6933-R7		1.5 gpm (5.7 L/min) (VR)	439.65	Chrome
28C6943		1.5 gpm (5.7 L/min) (STD)	402.65	Chrome

- Wall installation - 8" centers
 - 6" long spout, swings 360°
 - Cast body
 - Vandal resistant handles
 - Red/blue indicators
 - WITH integral check stops
 - CER-TECK® cartridges
 - For commercial use only
- R* = Optional gooseneck spout dimensions:
R7 = 9" long



CER-TECK® 28C6 with 6" Gooseneck Spout – 4" (102 mm) Blade Handle with Sanitary Hood

Model		Flow	Price	Finish
28C6924		1.5 gpm (5.7 L/min) (VRLAM)	445.35	Chrome
28C6934		1.5 gpm (5.7 L/min) (VR)	432.95	Chrome
28C6944		1.5 gpm (5.7 L/min) (STD)	428.15	Chrome

- Wall installation - 8" centers
- 6" long spout, swings 360°
- Cast body
- Vandal resistant handles
- Red/blue indicators
- WITH integral check stops
- CER-TECK® cartridges
- For commercial use only

MODEL NUMBER EXAMPLE:
Configurations vary, see below for availability.

28C8 1 8 3 - AC

Variation

0 = 5.5" (140 mm) plain spout*
1 = 8" (203 mm) spout with top/bottom brace*

*Distance from wall to spout outlet with spout end vacuum breaker

Outlet

6 = Spout end vacuum breaker
7 = Spout end vacuum breaker w/hose and hanger
8 = Body mounted vacuum breaker

Handle

3 = Hooded lever

AC = 5.5" to 10.5" adjustable centers



CER-TECK® 28C8 with 5.5" Plain Spout* – Rough Chrome-Plated – 3" (76 mm) Hooded Lever Handle

Model	Flow	Price	Finish
Spout End Vacuum Breaker			
28C8063	4.0 gpm (15.1 L/min)	416.40	Rough Chrome Plated
Spout End Vacuum Breaker with Hose and Hanger			
28C8073	4.0 gpm (15.1 L/min)	451.85	Rough Chrome Plated
Body Mounted Vacuum Breaker			
28C8083	4.0 gpm (15.1 L/min)	427.75	Rough Chrome Plated

- Wall installation – 8" centers
- Rigid spout
- Integral check stops
- Cast body
- Vandal resistant handles
- Red/blue indicators
- Plain spout
- Pail hook
- Garden hose end outlet
- CER-TECK® cartridges
- Not for potable water



CER-TECK® 28C8 with 8" Spout with Top/Bottom Brace* – Rough Chrome-Plated – 3" (76 mm) Hooded Lever Handle

Model	Flow	Price	Finish
Spout End Vacuum Breaker			
28C8163	4.0 gpm (15.1 L/min)	440.60	Rough Chrome Plated
Spout End Vacuum Breaker with Hose and Hanger			
28C8173	4.0 gpm (15.1 L/min)	476.00	Rough Chrome Plated
Body Mounted Vacuum Breaker			
28C8183	4.0 gpm (15.1 L/min)	451.90	Rough Chrome Plated

- Wall installation – 8" centers
- Rigid spout
- Integral check stops
- Cast body
- Vandal resistant handles
- Red/blue indicators
- Spout with top/bottom brace
- Pail hook
- Garden hose end outlet
- CER-TECK® cartridges
- Not for potable water



Mop Holder for 28C Wallmount Service Sink Faucets

Model	Flow	Price	Finish
28T910	N/A	82.05	Stainless Steel

- Stainless steel mop holder
- 3 spring loaded rubber grip holders



48" Hose and Hanger for 28C Wallmount Service Sink Faucets

Model	Flow	Price	Finish
28T911	N/A	45.60	Stainless Steel

- 48" hose and stainless steel hanger

*Distance from wall to spout outlet with spout end vacuum breaker.



28T9 Service Sink Faucet – Rough Chrome-Plated – Cross Handles

Model	Flow	Price	Finish
28T9	4.0 gpm (15.1 L/min)	214.60	Rough Chrome Plated
28T9-AC	4.0 gpm (15.1 L/min)	249.70	Rough Chrome Plated

- Wall installation - 8" centers
- 9.5" long vacuum breaker spout
- Rigid spout with top brace
- Pail hook
- Integral stops
- Cast body
- Cross handles
- Red/blue indicators
- Hose thread outlet
- In-line vacuum breaker
- Heavy duty cartridges
- AC = adjustable centers 5.5 - 10.5"
- Not for potable water



28C9LH Service Sink Faucet – Rough Chrome-Plated – 4" (102 mm) Lever Handles

Model	Flow	Price	Finish
28C9LH	4.0 gpm (15.1 L/min)	269.55	Rough Chrome Plated
28C9LH-AC	4.0 gpm (15.1 L/min)	304.60	Rough Chrome Plated

- Wall installation - 8" centers
- 9.5" long vacuum breaker spout
- Rigid spout with top brace
- Pail hook
- Integral stops
- Cast body
- 4" (102 mm) metal lever handles
- Red/blue indicators
- Hose thread outlet
- In-line vacuum breaker
- 1/4 turn ceramic cartridges
- AC = adjustable centers 5.5 - 10.5"
- Not for potable water

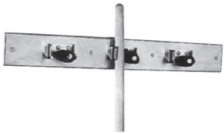

Mop Holder for 28C Wallmount Service Sink Faucets

Model	Flow	Price	Finish
28T910	N/A	82.05	Stainless Steel

- Stainless steel mop holder
- 3 spring loaded rubber grip holders



48" Hose and Hanger for 28C Wallmount Service Sink Faucets

Model	Flow	Price	Finish
28T911	N/A	45.60	Stainless Steel

- 48" hose and stainless steel hanger









Push-Button Metering Faucet – Single Hole

Model	Flow	Price	Finish
87T104	0.5 gpm (1.9 L/min)	183.95	Chrome
87T904	0.35 gpm (1.3 L/min)	183.95	Chrome
With Mixing Tee			
87T110	0.5 gpm (1.9 L/min)	225.80	Chrome

- 1-hole installation
- Cast brass body
- Vandal resistant push button
- Metering, slow-close push button
- 2.5" max deck thickness
- Vandal resistant spray outlet





ADA Lever Handle Metering Faucet – Single Hole

Model	Flow	Price	Finish
87T105 	0.5 gpm (1.9 L/min)	196.80	Chrome
87T905 	0.35 gpm (1.3 L/min)	196.80	Chrome
With Mixing Tee			
87T111 	0.5 gpm (1.9 L/min)	239.35	Chrome
87T911 	0.35 gpm (1.3 L/min)	239.35	Chrome

- 1-hole installation
- Cast brass body
- Vandal resistant ADA lever handle
- Metering, slow-close lever
- 2.5" max deck thickness
- Vandal resistant spray outlet



ADA Lever Handle Metering Faucet – 4" Cast Centerset

Model	Flow	Price	Finish
86T1153 	0.5 gpm (1.9 L/min)	326.40	Chrome
With Open Grid Strainer			
86T1053 	0.5 gpm (1.9 L/min)	346.85	Chrome
86T1093 	0.35 gpm (1.3 L/min)	346.85	Chrome

- 2-hole 4" installation
- Cast brass body
- Vandal resistant ADA lever handle
- Metering, slow-close lever
- Red/blue indicators
- 2.38" max deck thickness
- Vandal resistant spray outlet



Push-Button Metering Faucet – Single Hole

Model	Flow	Price	Finish
86T1104	0.5 gpm (1.9 L/min)	182.35	Chrome
86T1194	0.35 gpm (1.3 L/min)	182.35	Chrome
With 86T151 Coverplate			
86T0104	0.5 gpm (1.9 L/min)	208.40	Chrome
86T0194	0.35 gpm (1.3 L/min)	208.40	Chrome

- 1-hole installation
- Cast brass body
- Vandal resistant push button
- Metering, slow-close, push button
- 1.13" max deck thickness
- Vandal resistant spray outlet



Coverplate for Field Conversion

Model	Flow	Price	Finish
86T151	N/A	54.75	Chrome

- 4" coverplate
- For use with 86T1104 and 86T1194



Coverplate for Field Conversion

Model	Flow	Price	Finish
87T151	N/A	55.85	Chrome

- 4" coverplate
- For use with 87T series metering faucets



Washdown Urinal Valve

Model		Flow	Price	Finish
Back Inlet				
86T502		0.5 gpf (1.9 Lpf)	168.60	Chrome
Top Inlet				
86T503		0.5 gpf (1.9 Lpf)	168.60	Chrome
Back Inlet with Stop				
86T505		0.5 gpf (1.9 Lpf)	202.70	Chrome

- Cast body urinal valve
- For washdown urinal only
- Vandal resistant handle
- Metering, slow close lever style
- For 3/4" IP spud
- 1/2" universal FIP/copper sweat inlet
- Factory set flow rate, field adjustable
- **Installation Warning:** Model shown must be installed on a fixture providing sufficient air gap protection against backflow



Accessories for Field Conversion

Model		Flow	Price	Finish
86T610		N/A	85.00	Chrome

- 3/4" outlet tube with vacuum breaker
- For use with 86T502, 86T503 and 86T505





DELTA COMMERCIAL TECHNICAL SERVICE 1-877-509-2680
ONLINE CATALOG: deltafaucet.com (Complete Product Offering & Part Numbering System)



W62 Ball Valve Hose Cock

Model		Flow	Price	Finish
W6200AIR		N/A	62.35	Chrome
W6200CW*		N/A	62.35	Chrome
W6200GAS		N/A	62.35	Chrome
W6200VAC		N/A	62.35	Chrome

- Ball valve hose cock
- 3/8" MIP inlet
- No shank
- Non-removable lever handle
- CW not for potable water*



W62 Ball Valve Hose Cocks – Deckmount Turret

Model		Flow	Price	Finish
Single Ball Valve				
W6210AIR		N/A	138.90	Chrome
W6210CW*		N/A	138.90	Chrome
W6210GAS		N/A	138.90	Chrome
W6210VAC		N/A	138.90	Chrome
Two Ball Valves @ 90 degrees				
W6220AIR		N/A	210.60	Chrome
W6220GAS		N/A	210.60	Chrome
W6220VAC		N/A	210.60	Chrome
Two Ball Valves @ 180 degrees				
W6225AIR		N/A	210.60	Chrome
W6225CW*		N/A	210.60	Chrome
W6225GAS		N/A	210.60	Chrome
W6225VAC		N/A	210.60	Chrome

- Ball valve hose cock
- 1/4" IP tail
- 4.44" shank
- Non-removable lever handle
- CW not for potable water*



W62 Ball Valve Hose Cock – Wallmount with Flange

Model		Flow	Price	Finish
W6270AIR		N/A	116.90	Chrome
W6270CW*		N/A	116.90	Chrome
W6270GAS		N/A	116.90	Chrome
W6270VAC		N/A	116.90	Chrome

- Ball valve hose cock
- 1/4" IP tail
- 2.38" shank
- 1-7/8" wall flange
- Non-removable lever handle
- CW not for potable water*



W66 Pure Water Faucet – Valve Only

Model	Flow	Price	Finish
W6629DI	N/A	307.05	Chrome
W6629DW	N/A	307.05	Chrome

- Celcon® control valve ONLY
- Self-closing, spring loaded, full lock open handle
- Not for potable water



W66 Pure Water Faucet – Deckmount

Model	Flow	Price	Finish
W6635DI	N/A	494.95	Chrome
W6635DW	N/A	494.95	Chrome

- Deckmount pure water faucet
- Self-closing, spring loaded, full lock open handle
- 6" long, 15" high
- Not for potable water



Repair Kit

Model	Flow	Price	Finish
068128A	N/A	93.05	N/A

- Repair kit ONLY
- For W6629 control valve

MODEL NUMBER EXAMPLE:

Configurations vary, see below for availability.

W6601 - 9 - C

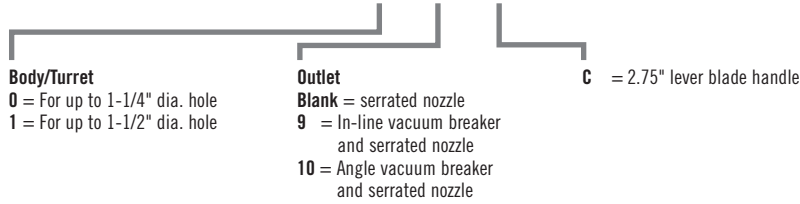

W66 Single Water Faucets For Up to 1-1/4" Diameter Hole

Model	Flow	Price	Finish
Serrated Nozzle			
W6600	N/A	184.80	Chrome
W6600-C	N/A	184.80	Chrome
In-line Vacuum Breaker and Serrated Nozzle			
W6600-9	N/A	259.85	Chrome
W6600-9-C	N/A	259.85	Chrome

- 1-hole installation
- 7/8" hole dia. recommended
- Deckmount gooseneck
- Serrated nozzle
- 6" long, 15" high
- Two-arm metal handle
- Color index
- Teck® lab structure
- Not for potable water



W66 Single Water Faucets For Up to 1-1/4" Diameter Hole

Model	Flow	Price	Finish
Angle Vacuum Breaker and Serrated Nozzle			
W6600-10	N/A	291.35	Chrome
W6600-10-C	N/A	291.35	Chrome

- 1-hole installation
- 7/8" hole dia. recommended
- Deckmount angle VB gooseneck
- Serrated nozzle
- 6" long, 15" high
- Two-arm metal handle
- Color index
- Teck® lab structure
- Not for potable water



W66 Single Water Faucets For Up to 1-1/2" Diameter Hole

Model	Flow	Price	Finish
Serrated Nozzle			
W6601	N/A	181.50	Chrome
W6601-C	N/A	181.50	Chrome
In-line Vacuum Breaker and Serrated Nozzle			
W6601-9	N/A	266.75	Chrome
W6601-9-C	N/A	266.75	Chrome

- 1-hole installation
- 1" hole dia. recommended
- Deckmount gooseneck
- Serrated nozzle
- 6" long, 16" high
- Two-arm metal handle
- Color index
- Teck® lab structure
- Not for potable water



W66 Single Water Faucets For Up to 1-1/2" Diameter Hole

Model	Flow	Price	Finish
Angle Vacuum Breaker and Serrated Nozzle			
W6601-10	N/A	266.75	Chrome
W6601-10-C	N/A	266.75	Chrome

- 1-hole installation
- 1" hole dia. recommended
- Deckmount angle VB gooseneck
- Serrated nozzle
- 6" long, 16" high
- Two-arm metal handle
- Color index
- Teck® lab structure
- Not for potable water

MODEL NUMBER EXAMPLE:
Configurations vary, see below for availability.

W6700-9-R7C

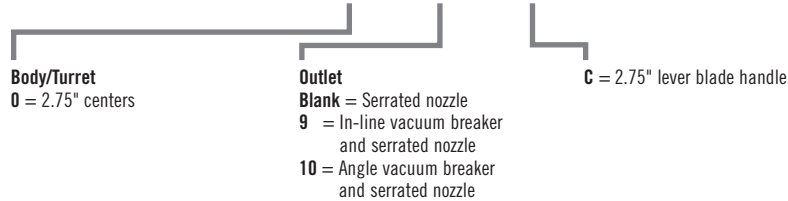

W67 Mixing Water Faucets – 2.75" Centers

Model	Flow	Price	Finish
Serrated Nozzle			
W6700	N/A	288.65	Chrome
W6700-C	N/A	288.65	Chrome
In-line Vacuum Breaker and Serrated Nozzle			
W6700-9	N/A	357.95	Chrome
W6700-9-C	N/A	357.95	Chrome

- 2-hole installation
- 7/8" hole dia. recommended
- Deckmount gooseneck
- Serrated nozzle
- 6" long, 15" high
- Two-arm metal handle
- Color index
- Teck® lab structure
- Not for potable water



W67 Mixing Water Faucets – 2.75" Centers

Model	Flow	Price	Finish
Angle Vacuum Breaker and Serrated Nozzle			
W6700-10	N/A	387.10	Chrome
W6700-10-C	N/A	387.10	Chrome

- 2-hole installation
- 7/8" hole dia. recommended
- Deckmount angle VB gooseneck
- Serrated nozzle
- 6" long, 15" high
- Two-arm metal handle
- Color index
- Teck® lab structure
- Not for potable water



W67 Mixing Water Faucets – 4" Centers

Model	Flow	Price	Finish
Serrated Nozzle			
W6720	N/A	224.30	Chrome
W6720-C	N/A	224.30	Chrome
In-line Vacuum Breaker and Serrated Nozzle			
W6720-9	N/A	296.55	Chrome
W6720-9-C	N/A	296.55	Chrome

- 2-hole 4" installation
- 1.75" max deck thickness
- Deckmount gooseneck
- Serrated nozzle
- 6" long, 14.85" high
- Two-arm metal handle
- Color index
- Teck® lab structure
- Not for potable water



W67 Mixing Water Faucets – 4" Centers

Model	Flow	Price	Finish
Angle Vacuum Breaker and Serrated Nozzle			
W6720-10	N/A	296.55	Chrome
W6720-10-C	N/A	296.55	Chrome

- 2-hole 4" installation
- 1.75" max deck thickness
- Deckmount angle VB gooseneck
- Serrated nozzle
- 6" long, 13.25" high
- 2-arm metal handle
- Color index
- Teck® lab structure
- Not for potable water



W67 Mixing Water Faucets – 8" Centers

Model	Flow	Price	Finish
Serrated Nozzle			
W6740	N/A	310.95	Chrome
W6740-C	N/A	310.95	Chrome
In-line Vacuum Breaker and Serrated Nozzle			
W6740-9	N/A	380.75	Chrome
W6740-9-C	N/A	380.75	Chrome

- 2-hole 8" installation
- 1.75" max deck thickness
- Deckmount gooseneck
- Serrated nozzle
- 6" long, 14.85" high
- Two-arm metal handle
- Color index
- Teck® lab structure
- Not for potable water



W67 Mixing Water Faucets – 8" Centers

Model	Flow	Price	Finish
Angle Vacuum Breaker and Serrated Nozzle			
W6740-10	N/A	380.75	Chrome
W6740-10-C	N/A	380.75	Chrome

- 2-hole 8" installation
- 1.75" max deck thickness
- Deckmount angle VB gooseneck
- Serrated nozzle
- 6" long, 13.25" high
- Two-arm metal handle
- Color index
- Teck® lab structure
- Not for potable water



W67 Mixing Water Faucets – Single Shank

Model	Flow	Price	Finish
Serrated Nozzle			
W6760	N/A	332.35	Chrome
In-line Vacuum Breaker and Serrated Nozzle			
W6760-9	N/A	398.55	Chrome

- Single hole installation
- 1.25" hole dia. recommended
- Deckmount gooseneck
- Serrated nozzle
- 6" long, 15.5" high
- Two-arm metal handle
- Color index
- Teck® lab structure
- Not for potable water



W67 Mixing Water Faucets – Single Shank

Model	Flow	Price	Finish
Angle Vacuum Breaker and Serrated Nozzle			
W6760-10	N/A	426.05	Chrome

- Single hole installation
- 1.25" hole dia. recommended
- Deckmount angle VB gooseneck
- Serrated nozzle
- 6" long, 15.5" high
- 2-arm metal handle
- Color index
- Teck® lab structure
- Not for potable water



MODEL NUMBER EXAMPLE:
Configurations vary, see below for availability.

54T5432A-R6

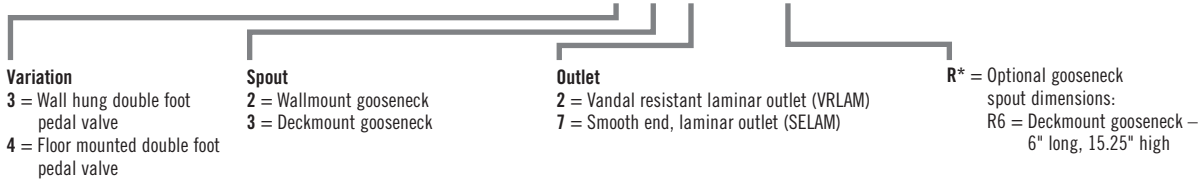

Mixing Surgeon Scrub-Up Valve, Wall Hung Double Foot Pedal Valve with Inlet & Outlet Stops & Deckmount Gooseneck Spout w/ Vandal Resistant Laminar Outlet

Model	Flow	Price	Finish
Deckmount Gooseneck (4.5" long, 12.2" high)			
54T5332A	1.5 gpm (5.7 L/min) (VRLAM)	794.30	Chrome

- Wallmount self-close double foot pedal valve
- Wall flanges
- Integral inlet/outlet stops
- For commercial use only



Mixing Surgeon Scrub-Up Valve, Double Floor Mount Foot Pedal Valve & Deckmount Gooseneck Spout w/ Vandal Resistant Laminar Outlet

Model	Flow	Price	Finish
Deckmount Gooseneck (4.5" long, 12.2" high)			
54T5432A	1.5 gpm (5.7 L/min) (VRLAM)	527.40	Chrome

- Floor mounted self-close double foot pedal valve
- Integral inlet/outlet stops
- For commercial use only
- R* = Optional gooseneck spout dimensions:
R6 = Deckmount gooseneck – 6" long, 15.25" high



Mixing Surgeon Scrub-Up Valve, Wall Hung Double Foot Pedal Valve with Inlet & Outlet Stops & Deckmount Gooseneck Spout with Smooth End Laminar Outlet

Model	Flow	Price	Finish
Deckmount Gooseneck (4.5" long)			
54T5327A	1.0 gpm (3.8 L/min) (SELAM)	1,001.75	Chrome

- Wallmount self-close double foot pedal valve
- Wall flanges
- Integral inlet/outlet stops
- For commercial use only



Mixing Surgeon Scrub-Up Valve, Wall Hung Double Foot Pedal Valve with Inlet & Outlet Stops & Deckmount Gooseneck Spout with Smooth End Laminar Outlet

Model	Flow	Price	Finish
Deckmount Gooseneck (4.5" long, 12.2" high)			
54T5337A	1.0 gpm (3.8 L/min) (SELAM)	971.21	Chrome

- Wallmount self-close double foot pedal valve
- Wall flanges
- Integral inlet/outlet stops
- For commercial use only



Pre-Rinse Faucets

MODEL NUMBER EXAMPLE:
Configurations vary, see below for availability.

55C1583 - S8

Variation
2 = 8" (203 mm) Deckmount
3 = 4" (102 mm) Deckmount
5 = 8" (203 mm) Wallmount

Outlet
1 = Spray with spring loaded S/S hose, auto shut-off
8 = Same as #1 outlet, but with add-on faucet

Handle
3 = 3" (76 mm) Hooded lever

S* = Optional swing spout dimensions:
S7 = 11" Tubular
S8 = 14" Tubular

CER-TECK® 55C Wallmount Pre-Rinse Faucet – 3" (76 mm) Hooded Lever Handles



Model		Flow	Price	Finish
55C1513		1.05 gpm (4.0 L/min)	826.15	Chrome
With Add-On Faucet				
55C1583		1.05 gpm (4.0 L/min)	1021.75	Chrome

- Wall installation - 8" centers
- Cast body
- Vandal resistant handles
- Red/blue indicators
- High pressure hose
- Stainless steel hose shield
- Integral check stops
- 12" wall bracket, thin wall kit
- Insulated spray head w/hook
- Add-on faucet: 1.5 gpm (5.7 L/min)
- CER-TECK® cartridges
- For commercial use only
- **S*** = Optional swing spout dimensions:
S7 = 11" Tubular
S8 = 14" Tubular

Wall Bracket



Model	Flow	Price	Finish
55P1000	N/A	62.85	Chrome

- 0 - 12" wall bracket ONLY

Pre-Rinse Faucets



Drainage

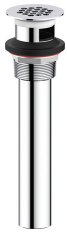

Grid Strainer with Overflow Holes

Model	Flow	Price	Finish
33T260	N/A	26.90	Chrome

- 1-1/4" grid strainer
- Cast brass body
- Overflow holes



Offset Grid Strainer with Overflow Holes

Model	Flow	Price	Finish
33T290 	N/A	50.50	Chrome

- 1-1/4" offset grid strainer
- Cast brass body
- Overflow holes



Cast P Trap Less Cleanout

Model	Flow	Price	Finish
33T301	N/A	58.55	Chrome

- 1-1/4" cast P trap
- Adjustable
- Less cleanout



Cast P Trap With Cleanout

Model	Flow	Price	Finish
33T311	N/A	60.05	Chrome

- 1-1/4" cast P trap
- Adjustable
- With cleanout



Cast P Trap With Cleanout

Model	Flow	Price	Finish
33T360	N/A	74.25	Chrome

- 1-1/2" cast P trap
- Adjustable
- With cleanout

Drainage



Tub/Shower

MODEL NUMBER EXAMPLE:

Configurations vary, see below for availability.

T13H 1 5 3 - 25

Variation

- 1 = Shower valve
- 2 = Tub & shower valve with pull-up diverter tub spout
- 3 = Shower valve with diverter for dual showers

Shower

- 0 = No shower head
- 2 = 3-setting Touch-Clean® shower head/arm/flange
- 3 = Shower head/arm/flange with Touch-Clean® spray holes
- 5 = Hand shower with 24" SS grab bar and ADA slide
- 6 = 30° VR wallmount shower head
- 8 = Shower head/arm/flange with H₂Okinetic® Technology

Handle

- 2 = 3.33" (85 mm) metal lever
- 3 = 2.24" (57 mm) lever blade

Options/Add-Ons

- 05 = 36" SS grab bar, replacing 24" bar
- 20 = 69 - 92" stretchable SS hose, replacing vinyl hose
- 25 = 36" SS grab bar AND 69 - 92" stretchable SS hose, replacing replacing 24" bar and vinyl hose

How To Order a Complete MultiChoice® T13H Series Tub/Shower Faucet



See page C132 for MultiChoice® Universal roughs.

T13H1 Shower Valve Only – Metal Lever Handle



Model	Flow	Price	Finish
T13H102	N/A	109.60	Chrome

- Single function pressure balance cartridge
- Order MultiChoice® Universal rough separately
- Vandal resistant lever handle adjusts temperature
- Red/blue indicator

T13H1 Shower Valve with 3-Setting Touch-Clean® Shower Head – Metal Lever Handle



Model	Flow	Price	Finish
T13H122	1.75 gpm (6.6 L/min)	186.05	Chrome

- Single function pressure balance cartridge
- Order MultiChoice® Universal rough separately
- Vandal resistant lever handle adjusts temperature
- Red/blue indicator
- Touch-Clean® 3-setting shower head is WaterSense® labeled
- Full Body Spray, Massage Spray, Soft Drench Spray
- Includes arm and flange

T13H1 Shower Valve with Touch-Clean® Shower Head – Metal Lever Handle



Model	Flow	Price	Finish
T13H132	1.5 gpm (5.7 L/min)	136.05	Chrome

- Single function pressure balance cartridge
- Order MultiChoice® Universal rough separately
- Vandal resistant lever handle adjusts temperature
- Red/blue indicator
- Touch-Clean® full body shower head is WaterSense® labeled
- Includes arm and flange

T13H1 Shower Valve with Hand Shower, SS Bar, ADA Slide – Metal Lever Handle



Model	Flow	Price	Finish
T13H152	1.5 gpm (5.7 L/min)	355.50	Chrome
T13H152-05*	1.5 gpm (5.7 L/min)	377.25	Chrome
T13H152-20*	1.5 gpm (5.7 L/min)	397.00	Chrome
T13H152-25*	1.5 gpm (5.7 L/min)	418.75	Chrome

*Refer to Model Number Example for Options/Add-Ons

- Single function pressure balance cartridge
- Order MultiChoice® Universal rough separately
- Vandal resistant lever handle adjusts temperature
- Red/blue indicator
- 24" long, 1-1/2" stainless slide bar/grab bar
- ADA adjustable mount
- Hand shower and 70" vinyl hose
- ADA compliant grab bar when installed per accessibility guidelines of the act
- Touch-Clean® 2-setting hand shower is WaterSense® labeled
- Pause, Full Body Spray

Valve rating is 1.2 GPM minimum (4.5 L/min) for 13, 14, 17 series pressure-balance and 17T series thermostatic at 45 psi (310kPa). Stated flow rate for shower heads @80 psi maximum water usage. ASME A112.1016/ASSE 1016/CSA B125.16

DELTA COMMERCIAL TECHNICAL SERVICE 1-877-509-2680
 ONLINE CATALOG: deltafaucet.com (Complete Product Offering & Part Numbering System)



T13H1 Shower Valve with 30° VR Wallmount Shower Head – Metal Lever Handle

Model	Flow	Price	Finish
T13H162	1.5 gpm (5.7 L/min)	302.25	Chrome

- Single function pressure balance cartridge
- Order MultiChoice® Universal rough separately
- Vandal resistant lever handle adjusts temperature
- Red/blue indicator
- 30° vandal resistant cast shower head



T13H1 Shower Valve with H₂Okinetic® Shower Head – Metal Lever Handle

Model	Flow	Price	Finish
T13H182	1.5 gpm (5.7 L/min)	173.90	Chrome

- Single function pressure balance cartridge
- Order MultiChoice® Universal rough separately
- Vandal resistant lever handle adjusts temperature
- Red/blue indicator
- H₂Okinetic® shower head
- Includes arm and flange



T13H1 Shower Valve Only – Lever Blade Handle

Model	Flow	Price	Finish
T13H103	N/A	109.60	Chrome

- Single function pressure balance cartridge
- Order MultiChoice® Universal rough separately
- Vandal resistant blade handle adjusts temperature
- Red/blue indicator



T13H1 Shower Valve with 3-Setting Touch-Clean® Shower Head – Lever Blade Handle

Model	Flow	Price	Finish
T13H123	1.75 gpm (6.6 L/min)	186.05	Chrome

- Single function pressure balance cartridge
- Order MultiChoice® Universal rough separately
- Vandal resistant blade handle adjusts temperature
- Red/blue indicator
- Touch-Clean® 3-setting shower head is WaterSense® labeled
- Full Body Spray, Massage Spray, Soft Drench Spray
- Includes arm and flange



T13H1 Shower Valve and Touch-Clean® Shower Head – Lever Blade Handle

Model	Flow	Price	Finish
T13H133	1.5 gpm (5.7 L/min)	136.05	Chrome

- Single function pressure balance cartridge
- Order MultiChoice® Universal rough separately
- Vandal resistant blade handle adjusts temperature
- Red/blue indicator
- Touch-Clean® full body shower head is WaterSense® labeled
- Includes arm and flange



T13H1 Shower Valve with Hand Shower, SS Bar, ADA Slide – Lever Blade Handle

Model	Flow	Price	Finish
T13H153	1.5 gpm (5.7 L/min)	336.95	Chrome
T13H153-05*	1.5 gpm (5.7 L/min)	377.25	Chrome
T13H153-20*	1.5 gpm (5.7 L/min)	397.00	Chrome
T13H153-25*	1.5 gpm (5.7 L/min)	418.75	Chrome

*Refer to Model Number Example for Options/Add-Ons

- Single function pressure balance cartridge
- Order MultiChoice® Universal rough separately
- Vandal resistant blade handle adjusts temperature
- Red/blue indicator
- 24" long, 1-1/2" stainless slide bar/grab bar
- ADA adjustable mount
- Hand shower and 70" vinyl hose
- ADA compliant grab bar when installed per accessibility guidelines of the act
- Touch-Clean® 2-setting hand shower is WaterSense® labeled
- Pause, Full Body Spray

Valve rating is 1.2 GPM minimum (4.5 L/min) for 13, 14, 17 series pressure-balance and 17T series thermostatic at 45 psi (310kPa). Stated flow rate for shower heads @80 psi maximum water usage. ASME A112.1016/ASSE 1016/CSA B125.16

T13H1 Shower Valve with 30° VR Wallmount Shower Head – Lever Blade Handle



Model	Flow	Price	Finish
T13H163	1.5 gpm (5.7 L/min)	302.25	Chrome

- Single function pressure balance cartridge
- Order MultiChoice® Universal rough separately
- Vandal resistant blade handle adjusts temperature
- Red/blue indicator
- 30° vandal resistant cast shower head

T13H1 Shower Valve with H₂Okinetic® Shower Head – Lever Blade Handle



Model	Flow	Price	Finish
T13H183	1.5 gpm (5.7 L/min)	173.90	Chrome

- Single function pressure balance cartridge
- Order MultiChoice® Universal rough separately
- Vandal resistant blade handle adjusts temperature
- Red/blue indicator
- H₂Okinetic® shower head
- Includes arm and flange

T13H2 Tub/Shower Valve with Diverter Spout and Touch-Clean® Shower Head – Lever Blade Handle



Model	Flow	Price	Finish
T13H233	1.5 gpm (5.7 L/min)	161.80	Chrome

ADA for valve control only

- Single function pressure balance cartridge
- Order MultiChoice® Universal rough separately
- Vandal resistant blade handle adjusts temperature
- Red/blue indicator
- 1/2" IPS metal spout with pull-up diverter, not ADA
- Touch-Clean® full body shower head is WaterSense® labeled
- Includes arm and flange

T13H2 Tub/Shower Valve with Diverter Spout and Hand Shower, SS Bar, ADA Slide – Lever Blade Handle



Model	Flow	Price	Finish
T13H253	1.5 gpm (5.7 L/min)	381.30	Chrome

- Single function pressure balance cartridge
- Order MultiChoice® Universal rough separately
- Vandal resistant blade handle adjusts temperature
- Red/blue indicator
- 1/2" IPS metal spout with pull-up diverter, not ADA
- 24" long, 1-1/2" stainless slide bar/grab bar
- ADA adjustable hand shower mount
- Hand shower and 70" vinyl hose
- ADA compliant grab bar when installed per accessibility guidelines of the act
- Touch-Clean® 2-setting hand shower is WaterSense® labeled
- Pause, Full Body Spray

T13H2 Tub/Shower Valve with Diverter Spout and H₂Okinetic® Shower Head – Lever Blade Handle



Model	Flow	Price	Finish
T13H283	1.5 gpm (5.7 L/min)	199.85	Chrome

ADA for valve control only

- Single function pressure balance cartridge
- Order MultiChoice® Universal rough separately
- Vandal resistant blade handle adjusts temperature
- Red/blue indicator
- 1/2" IPS metal spout with pull-up diverter, not ADA
- H₂Okinetic® shower head
- Includes arm and flange

Tub/Shower

Valve rating is 1.2 GPM minimum (4.5 L/min) for 13, 14, 17 series pressure-balance and 17T series thermostatic at 45 psi (310kPa). Stated flow rate for shower heads @80 psi maximum water usage. ASME A112.1016/ASSE 1016/CSA B125.16

DELTA COMMERCIAL TECHNICAL SERVICE 1-877-509-2680
 ONLINE CATALOG: deltafaucet.com (Complete Product Offering & Part Numbering System)



T13H3 Shower Valve Only with Diverter Valve for Dual Showers – Metal Lever Handle

Model	Flow	Price	Finish
T13H302	1.5 gpm (5.7 L/min)	533.95	Chrome
T13H302-05*	1.5 gpm (5.7 L/min)	555.75	Chrome
T13H302-20*	1.5 gpm (5.7 L/min)	575.30	Chrome
T13H302-25*	1.5 gpm (5.7 L/min)	597.15	Chrome

* Refer to Model Number Example for Options/Add-Ons

- Single function pressure balance cartridge
- Diverter valve
- Order R10700-UNWS MultiChoice® Universal rough separately
- Vandal resistant lever handle adjusts temperature
- Red/blue indicator
- 24" long, 1-1/2" stainless slide bar/grab bar
- ADA adjustable mount
- Hand shower and 70" vinyl hose
- ADA compliant grab bar when installed per accessibility guidelines of the act
- Touch-Clean® 2-setting hand shower is WaterSense® labeled
- Pause, Full Body Spray



T13H3 Shower Valve with Diverter Valve for Dual Shower with Touch-Clean® Shower Head – Metal Lever Handle

Model	Flow	Price	Finish
T13H332	1.5 gpm (5.7 L/min)	560.35	Chrome

- Single function pressure balance cartridge
- Diverter valve
- Order R10700-UNWS MultiChoice® Universal rough separately
- Vandal resistant lever handle adjusts temperature
- Red/blue indicator
- 24" long, 1-1/2" stainless slide bar/grab bar
- ADA adjustable hand shower mount
- Hand shower and 70" vinyl hose
- ADA compliant grab bar when installed per accessibility guidelines of the act
- Touch-Clean® 2-setting hand shower is WaterSense® labeled
- Pause, Full Body Spray
- Touch-Clean® full body shower head is WaterSense® labeled
- Includes arm and flange



T13H3 Shower Valve Only with Diverter Valve for Dual Showers – Lever Blade Handle

Model	Flow	Price	Finish
T13H303	1.5 gpm (5.7 L/min)	533.95	Chrome
T13H303-05*	1.5 gpm (5.7 L/min)	555.75	Chrome
T13H303-20*	1.5 gpm (5.7 L/min)	575.30	Chrome
T13H303-25*	1.5 gpm (5.7 L/min)	597.15	Chrome

* Refer to Model Number Example for Options/Add-Ons

- Single function pressure balance cartridge
- Diverter valve
- Order R10700-UNWS MultiChoice® Universal rough separately
- Vandal resistant blade handle adjusts temperature
- Red/blue indicator
- 24" long, 1-1/2" stainless slide bar/grab bar
- ADA adjustable mount
- Hand shower and 70" vinyl hose
- ADA compliant grab bar when installed per accessibility guidelines of the act
- Touch-Clean® 2-setting hand shower is WaterSense® labeled
- Pause, Full Body Spray

Valve rating is 1.2 GPM minimum (4.5 L/min) for 13, 14, 17 series pressure-balance and 17T series thermostatic at 45 psi (310kPa). Stated flow rate for shower heads @80 psi maximum water usage. ASME A112.1016/ASSE 1016/CSA B125.16



T13H3 Shower Valve with Diverter Valve for Dual Showers with Touch-Clean® Shower Head – Lever Blade Handle

Model	Flow	Price	Finish
T13H333	1.5 gpm (5.7 L/min)	560.35	Chrome

- Single function pressure balance cartridge
- Diverter valve
- Order R10700-UNWS MultiChoice® Universal rough separately
- Vandal resistant blade handle adjusts temperature
- Red/blue indicator
- 24" long, 1-1/2" stainless slide bar/grab bar
- ADA adjustable hand shower mount
- Hand shower and 70" vinyl hose
- ADA compliant grab bar when installed per accessibility guidelines of the act
- Touch-Clean® 2-setting hand shower is WaterSense® labeled
- Pause, Full Body Spray
- Touch-Clean® full body shower head is WaterSense® labeled
- Includes arm and flange

MultiChoice® Rough-Ins



Model	Flow	Price	Finish
R10000-UNWS	N/A	100.35	N/A

- Valve body only
- Accepts single-function (13/14), dual function (17), or dual function thermostatic (17T) cartridge
- Cartridge ships with trim
- 1/2" universal inlets accept 1/2" copper, 1/2" iron pipe, PEX or CPVC adaptors
- 1/2" universal outlets, inlets/outlets have male threads
- Back-to-back capability
- With stops

MultiChoice® Rough-Ins



Model	Flow	Price	Finish
R10700-UNWS	N/A	141.30	N/A

- For use with MultiChoice® Universal T13H and T17TH series with diverter valve for dual showers
- Handle and flange ships with trim
- Valve and diverter cartridges ship with trim kit
- With stops

Refer to pages C35-C36 in the Quick Pick Section for a complete list of MultiChoice® Universal roughs.

Tub/Shower

Valve rating is 1.2 GPM minimum (4.5 L/min) for 13, 14, 17 series pressure-balance and 17T series thermostatic at 45 psi (310kPa). Stated flow rate for shower heads @80 psi maximum water usage. ASME A112.1016/ASSE 1016/CSA B125.16

DELTA COMMERCIAL TECHNICAL SERVICE 1-877-509-2680
 ONLINE CATALOG: deltafaucet.com (Complete Product Offering & Part Numbering System)

MODEL NUMBER EXAMPLE:
Configurations vary, see below for availability.

T17TH155-25

Variation

- 1 = Shower valve
- 3 = Shower valve with diverter for dual showers

Shower

- 0 = No shower head
- 2 = 3-setting shower head/arm/flange with Touch-Clean® spray holes
- 3 = Shower head/arm/flange with Touch-Clean® spray holes
- 5 = Hand shower with 24" SS grab bar and ADA slide

Handle

- 5 = Metal lever volume control with temperature adjustment

Options/Add-Ons

- 05 = 36" SS grab bar, replacing 24" bar
- 20 = 69 - 92" stretchable SS hose, replacing vinyl hose
- 25 = 36" SS grab bar AND 69 - 92" stretchable SS hose, replacing 24" bar and vinyl hose

How To Order a Complete MultiChoice® T17TH Series Tub/Shower Faucet



See page C134 for MultiChoice® Universal roughs.

T17TH1 Shower Valve Only



Model	Flow	Price	Finish
T17TH105	N/A	423.65	Chrome

- Single function thermostatic cartridge
- Order MultiChoice® Universal rough separately
- Vandal resistant handle adjusts volume
- Dial adjusts temperature
- Red/blue indicator

T17TH1 Shower Valve with 3-Setting Touch-Clean® Shower Head



Model	Flow	Price	Finish
T17TH125	1.75 gpm (6.6 L/min)	500.10	Chrome

- Single function thermostatic cartridge
- Order MultiChoice® Universal rough separately
- Vandal resistant handle adjusts volume
- Dial adjusts temperature
- Red/blue indicator
- Touch-Clean® 3-setting shower head is WaterSense® labeled
- Full Body Spray, Massage Spray, Soft Drench Spray
- Includes arm and flange

T17TH1 Shower Valve with Touch-Clean® Shower Head



Model	Flow	Price	Finish
T17TH135	1.75 gpm (6.6 L/min)	450.10	Chrome

- Single function thermostatic cartridge
- Order MultiChoice® Universal rough separately
- Vandal resistant handle adjusts volume
- Dial adjusts temperature
- Red/blue indicator
- Touch-Clean® full body shower head is WaterSense® labeled
- Includes arm and flange

Valve rating is 1.2 GPM minimum (4.5 L/min) for 13, 14, 17 series pressure-balance and 17T series thermostatic at 45 psi (310kPa). Stated flow rate for shower heads @80 psi maximum water usage. ASME A112.1016/ASSE 1016/CSA B125.16



T17TH1 Shower Valve with Hand Shower, SS Bar, ADA Slide

Model		Flow	Price	Finish
T17TH155		2.5 gpm (9.5 L/min)	669.65	Chrome
T17TH155-05*		2.5 gpm (9.5 L/min)	691.40	Chrome
T17TH155-20*		2.5 gpm (9.5 L/min)	711.05	Chrome
T17TH155-25*		2.5 gpm (9.5 L/min)	732.85	Chrome

* Refer to Model Number Example for Options/Add-Ons
889.40

- Single function thermostatic cartridge
- Order MultiChoice® Universal rough separately
- Vandal resistant handle adjusts volume
- Dial adjusts temperature
- Red/blue indicator
- 24" long, 1-1/2" stainless slide bar/grab bar
- ADA adjustable mount
- Hand shower and 70" vinyl hose
- ADA compliant grab bar when installed per accessibility guidelines of the act
- Touch-Clean® 2-setting hand shower – Pause, Full Body Spray



T17TH3 Shower Valve Only with Diverter Valve for Dual Showers

Model		Flow	Price	Finish
T17TH305		2.5 gpm (9.5 L/min)	848.00	Chrome
T17TH305-05*		2.5 gpm (9.5 L/min)	869.75	Chrome
T17TH305-20*		2.5 gpm (9.5 L/min)	889.40	Chrome
T17TH305-25*		2.5 gpm (9.5 L/min)	911.20	Chrome

* Refer to Model Number Example for Options/Add-Ons

- Single function thermostatic cartridge
- Diverter valve
- Order R10700-UNWS MultiChoice® Universal rough separately
- Vandal resistant handle adjusts volume
- Dial adjusts temperature
- Red/blue indicator
- 24" long, 1-1/2" stainless slide bar/grab bar
- ADA adjustable mount
- Hand shower and 70" vinyl hose
- ADA compliant grab bar when installed per accessibility guidelines of the act
- Touch-Clean® 2-setting hand shower – Pause, Full Body Spray

MultiChoice® Rough-Ins



Model	Flow	Price	Finish
R10000-UNWS	N/A	100.35	N/A

- Valve body only
- Accepts single-function (13/14), dual function (17), or dual function thermostatic (17T) cartridge
- Cartridge ships with trim
- 1/2" universal inlets accept 1/2" copper, 1/2" iron pipe, PEX or CPVC adaptors
- 1/2" universal outlets, inlets/outlets have male threads
- Back-to-back capability
- With stops

MultiChoice® Rough-Ins



Model	Flow	Price	Finish
R10700-UNWS	N/A	141.30	N/A

- For use with MultiChoice® Universal T13H and T17TH series with diverter valve for dual showers
- Handle and flange ships with trim
- Valve and diverter cartridges ship with trim kit
- With stops

Tub/Shower

Refer to pages C35-C36 in the Quick Pick Section for a complete list of MultiChoice® Universal roughs.

Valve rating is 1.2 GPM minimum (4.5 L/min) for 13, 14, 17 series pressure-balance and 17T series thermostatic at 45 psi (310kPa). Stated flow rate for shower heads @80 psi maximum water usage. ASME A112.1016/ASSE 1016/CSA B125.16

DELTA COMMERCIAL TECHNICAL SERVICE 1-877-509-2680
ONLINE CATALOG: deltafaucet.com (Complete Product Offering & Part Numbering System)



MODEL NUMBER EXAMPLE:
Configurations vary, see below for availability.

810DPA20 - BL

Power Option

0 = Hardwire operated
1 = Battery operated
(Surface mount box only)

Flow Rate

2 = 1.0 gpm (3.8 L/min)
5 = 0.5 gpm (1.9 L/min)
9 = 0.35 gpm (1.3 L/min)

Control Box Option

0 = Surface mount box
8TR = Trim ONLY for recessed box

Finish

Blank = Chrome
SS = Stainless Steel
BL = Matte Black
CZ = Champagne Bronze*

NEW!

Architectural™ Design Series: Proximity® Deck Mount Bathroom Faucet



Model	Flow	Price	Finish
Hardwire			
810DPA20	1.0 gpm (3.8 L/min)	750.00	Chrome
810DPA20-BL	1.0 gpm (3.8 L/min)	1,050.00	Matte Black
810DPA20-CZ	1.0 gpm (3.8 L/min)	1,125.00	Champagne Bronze*
810DPA20-SS	1.0 gpm (3.8 L/min)	937.50	Brilliance® Stainless
810DPA90	0.35 gpm (1.32 L/min)	750.00	Chrome
810DPA90-SS	0.35 gpm (1.32 L/min)	937.50	Matte Black
810DPA90-BL	0.35 gpm (1.32 L/min)	1,050.00	Champagne Bronze*
810DPA90-CZ	0.35 gpm (1.32 L/min)	1,125.00	Brilliance® Stainless
Battery			
811DPA50	0.5 gpm (1.32 L/min)	750.00	Chrome
811DPA50-SS	0.5 gpm (1.32 L/min)	937.50	Matte Black
811DPA50-BL	0.5 gpm (1.32 L/min)	1,050.00	Champagne Bronze*
811DPA50-CZ	0.5 gpm (1.32 L/min)	1,125.00	Brilliance® Stainless

- Driftex™ Collection Proximity® faucet
- 1-hole installation
- Hands-free activation
- Proximity® Sensing Technology, entire spout is sensor
- 3 aerator options are available with each faucet – laminar, aerated, and Mikado spray outlets
- Adjustable sensing range, auto shut-off, metering mode, and periodic rinse feature
- Surface mounted control box
- Mixing valve required
- 2 1/2" max. deck thickness
- Serviceable filter screen upstream of the valve
- Order 061269 for 4" optional cover plate
- Hardwire with battery back-up order 063269A for recessed mount box; transformer required
- Hardwire, order AC filter (063271A) and transformer separately

NEW!

Architectural™ Design Series: Proximity® Deck Mount Bathroom Faucet Trim ONLY



Model	Flow	Price	Finish
810DPA28TR	1.0 gpm (3.8 L/min)	637.60	Chrome
810DPA28TR-SS	1.0 gpm (3.8 L/min)	797.00	Matte Black
810DPA28TR-BL	1.0 gpm (3.8 L/min)	892.64	Champagne Bronze*
810DPA28TR-CZ	1.0 gpm (3.8 L/min)	956.40	Brilliance® Stainless
810DPA98TR	0.35 gpm (1.32 L/min)	637.60	Chrome
810DPA98TR-SS	0.35 gpm (1.32 L/min)	797.00	Matte Black
810DPA98TR-BL	0.35 gpm (1.32 L/min)	892.64	Champagne Bronze*
810DPA98TR-CZ	0.35 gpm (1.32 L/min)	956.40	Brilliance® Stainless

- Contrast™ Collection Proximity® faucet
- 1-hole installation
- Hands-free activation
- Trim ONLY, requires separate order of ELAVT0008ARI for complete product
- Proximity® Sensing Technology, entire spout is sensor
- Recessed mounted control box
- Adjustable sensing range, auto shut-off, metering mode, and periodic rinse feature
- Surface mounted control box
- Mixing valve required
- Serviceable filter screen upstream of the valve
- 2 1/2" max. deck thickness
- 3 aerator options are available with each faucet – laminar, aerated, and Mikado spray outlets
- Order 061269 for 4" optional cover plate
- Hardwire with battery back-up order 063269A for recessed mount box; transformer required
- Hardwire, order AC filter (063271A) and transformer separately

Rough-in ONLY – For Use with Trim
(Must order trim number separately AND rough-in for complete product)

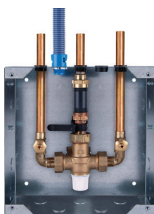

Model	Flow	Price	Finish
ELAVT0008ARI	N/A	806.90	N/A

- Rough-in ONLY, with thermostatic mixing valve
- Recessed mount 10" x 10" box with thermostatic mixing valve
- Must order TRIM for complete model

See page C62 for available transformers. Mixing valve required; mechanical mixer (R2910-MIXLF) or thermostatic mixer (R3270-MIXLF).

DELTA COMMERCIAL TECHNICAL SERVICE 1-877-509-2680
ONLINE CATALOG: deltafaucet.com (Complete Product Offering & Part Numbering System)

Architectural™ Design Series

MODEL NUMBER EXAMPLE:
Configurations vary, see below for availability.

820DPA20 - SS

Power Option

- 0 = Hardwire operated
- 1 = Battery operated
(Surface mount box only)

Flow Rate

- 2 = 1.0 gpm (3.8 L/min)
- 5 = 0.5 gpm (1.9 L/min)
- 9 = 0.35 gpm (1.3 L/min)

Control Box Option

- 0 = Surface mount box
- 8TR = Trim ONLY for recessed box

Finish

- Blank = Chrome
- SS = Stainless Steel
- BL = Matte Black
- CZ = Champagne Bronze®

NEW!



Architectural™ Design Series: Proximity® Deck Mount Bathroom Faucet

Model	Flow	Price	Finish
Hardwire			
820DPA20	1.0 gpm (3.8 L/min)	750.00	Chrome
820DPA20-BL	1.0 gpm (3.8 L/min)	1,050.00	Matte Black
820DPA20-CZ	1.0 gpm (3.8 L/min)	1,125.00	Champagne Bronze®
820DPA20-SS	1.0 gpm (3.8 L/min)	937.50	Brilliance® Stainless
820DPA90	0.35 gpm (1.32 L/min)	750.00	Chrome
820DPA90-SS	0.35 gpm (1.32 L/min)	937.50	Matte Black
820DPA90-BL	0.35 gpm (1.32 L/min)	1,050.00	Champagne Bronze®
820DPA90-CZ	0.35 gpm (1.32 L/min)	1,125.00	Brilliance® Stainless
Battery			
821DPA50	0.5 gpm (1.32 L/min)	750.00	Chrome
821DPA50-SS	0.5 gpm (1.32 L/min)	937.50	Matte Black
821DPA50-BL	0.5 gpm (1.32 L/min)	1,050.00	Champagne Bronze®
821DPA50-CZ	0.5 gpm (1.32 L/min)	1,125.00	Brilliance® Stainless

- Contrasta™ Collection Proximity® faucet
- 1-hole installation
- Hands-free activation
- Proximity® Sensing Technology, entire spout is sensor
- 3 aerator options are available with each faucet – laminar, aerated, and Mikado spray outlets
- Adjustable sensing range, auto shut-off, metering mode, and periodic rinse feature
- Surface mounted control box
- Mixing valve required
- 2 1/2" max. deck thickness
- Serviceable filter screen upstream of the valve
- Order 061305 for 4" optional cover plate
- Hardwire with battery back-up order 063269A for recessed mount box; transformer required
- Hardwire, order AC filter (063271A) and transformer separately

NEW!



Architectural™ Design Series: Proximity® Deck Mount Bathroom Faucet Trim ONLY

Model	Flow	Price	Finish
820DPA28TR	1.0 gpm (3.8 L/min)	637.60	Chrome
820DPA28TR-SS	1.0 gpm (3.8 L/min)	797.00	Matte Black
820DPA28TR-BL	1.0 gpm (3.8 L/min)	892.64	Champagne Bronze®
820DPA28TR-CZ	1.0 gpm (3.8 L/min)	956.40	Brilliance® Stainless
820DPA98TR	0.35 gpm (1.32 L/min)	637.60	Chrome
820DPA98TR-SS	0.35 gpm (1.32 L/min)	797.00	Matte Black
820DPA98TR-BL	0.35 gpm (1.32 L/min)	892.64	Champagne Bronze®
820DPA98TR-CZ	0.35 gpm (1.32 L/min)	956.40	Brilliance® Stainless

- Contrasta™ Collection Proximity® faucet
- 1-hole installation
- Hands-free activation
- Trim ONLY, requires separate order of ELAVT0008ARI for complete product
- Proximity® Sensing Technology, entire spout is sensor
- Recessed mounted control box
- Adjustable sensing range, auto shut-off, metering mode, and periodic rinse feature
- Surface mounted control box
- Mixing valve required
- Serviceable filter screen upstream of the valve
- 2 1/2" max. deck thickness
- 3 aerator options are available with each faucet – laminar, aerated, and Mikado spray outlets
- Order 061305 for 4" optional cover plate
- Hardwire with battery back-up order 063269A for recessed mount box; transformer required
- Hardwire, order AC filter (063271A) and transformer separately

Rough-in ONLY – For Use with Trim
(Must order trim number separately AND rough-in for complete product)

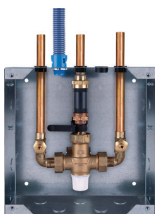

Model	Flow	Price	Finish
ELAVT0008ARI	N/A	806.90	N/A

- Rough-in ONLY, with thermostatic mixing valve
- Recessed mount 10" x 10" box with thermostatic mixing valve
- Must order TRIM for complete model

See page C62 for available transformers. Mixing valve required; mechanical mixer (R2910-MIXLF) or thermostatic mixer (R3270-MIXLF).

MODEL NUMBER EXAMPLE:

Configurations vary, see below for availability.

830DPA20 - CZ

Power Option

0 = Hardwire operated
1 = Battery operated
(Surface mount box only)

Flow Rate

2 = 1.0 gpm (3.8 L/min)
5 = 0.5 gpm (1.9 L/min)
9 = 0.35 gpm (1.3 L/min)

Control Box Option

0 = Surface mount box
8TR = Trim ONLY for recessed box

Finish

Blank = Chrome
SS = Stainless Steel
BL = Matte Black
CZ = Champagne Bronze*

NEW!



Architectural™ Design Series: Proximity® Deck Mount Bathroom Faucet

Model	Flow	Price	Finish
Hardwire			
830DPA20	1.0 gpm (3.8 L/min)	750.00	Chrome
830DPA20-BL	1.0 gpm (3.8 L/min)	1,050.00	Matte Black
830DPA20-CZ	1.0 gpm (3.8 L/min)	1,125.00	Champagne Bronze*
830DPA20-SS	1.0 gpm (3.8 L/min)	937.50	Brilliance® Stainless
830DPA90	0.35 gpm (1.32 L/min)	750.00	Chrome
830DPA90-SS	0.35 gpm (1.32 L/min)	937.50	Matte Black
830DPA90-BL	0.35 gpm (1.32 L/min)	1,050.00	Champagne Bronze*
830DPA90-CZ	0.35 gpm (1.32 L/min)	1,125.00	Brilliance® Stainless
Battery			
831DPA50	0.5 gpm (1.32 L/min)	750.00	Chrome
831DPA50-SS	0.5 gpm (1.32 L/min)	937.50	Matte Black
831DPA50-BL	0.5 gpm (1.32 L/min)	1,050.00	Champagne Bronze*
831DPA50-CZ	0.5 gpm (1.32 L/min)	1,125.00	Brilliance® Stainless

- Rustica™ Collection Proximity® faucet
- 1-hole installation
- Hands-free activation
- Proximity® Sensing Technology, entire spout is sensor
- 3 aerator options are available with each faucet – laminar, aerated, and Mikado spray outlets
- Adjustable sensing range, auto shut-off, metering mode, and periodic rinse feature
- Surface mounted control box
- Mixing valve required
- 2 1/2" max. deck thickness
- Serviceable filter screen upstream of the valve
- Order 061269* for 4" optional cover plate
- Hardwire with battery back-up order 063269A for recessed mount box; transformer required
- Hardwire, order AC filter (063271A) and transformer separately

NEW!



Architectural™ Design Series: Proximity® Deck Mount Bathroom Faucet Trim ONLY

Model	Flow	Price	Finish
830DPA28TR	1.0 gpm (3.8 L/min)	637.60	Chrome
830DPA28TR-SS	1.0 gpm (3.8 L/min)	797.00	Matte Black
830DPA28TR-BL	1.0 gpm (3.8 L/min)	892.64	Champagne Bronze*
830DPA28TR-CZ	1.0 gpm (3.8 L/min)	956.40	Brilliance® Stainless
830DPA98TR	0.35 gpm (1.32 L/min)	637.60	Chrome
830DPA98TR-SS	0.35 gpm (1.32 L/min)	797.00	Matte Black
830DPA98TR-BL	0.35 gpm (1.32 L/min)	892.64	Champagne Bronze*
830DPA98TR-CZ	0.35 gpm (1.32 L/min)	956.40	Brilliance® Stainless

- Contrasta™ Collection Proximity® faucet
- 1-hole installation
- Hands-free activation
- Trim ONLY, requires separate order of ELAVT0008ARI for complete product
- Proximity® Sensing Technology, entire spout is sensor
- Recessed mounted control box
- Adjustable sensing range, auto shut-off, metering mode, and periodic rinse feature
- Surface mounted control box
- Mixing valve required
- Serviceable filter screen upstream of the valve
- 2 1/2" max. deck thickness
- 3 aerator options are available with each faucet – laminar, aerated, and Mikado spray outlets
- Order 061269* for 4" optional cover plate
- Hardwire with battery back-up order 063269A for recessed mount box; transformer required
- Hardwire, order AC filter (063271A) and transformer separately

Rough-in ONLY – For Use with Trim
(Must order trim number separately AND rough-in for complete product)

Model	Flow	Price	Finish
ELAVT0008ARI	N/A	806.90	N/A

- Rough-in ONLY, with thermostatic mixing valve
- Recessed mount 10" x 10" box with thermostatic mixing valve
- Must order TRIM for complete model

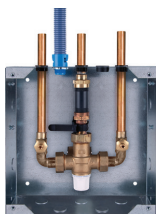

See page C62 for available transformers. Mixing valve required; mechanical mixer (R2910-MIXLF) or thermostatic mixer (R3270-MIXLF).

DELTA COMMERCIAL TECHNICAL SERVICE 1-877-509-2680
ONLINE CATALOG: deltafaucet.com (Complete Product Offering & Part Numbering System)

Architectural™ Design Series





Mechanical Mixer

Model	Flow	Price	Finish
R2910-MIXLF	N/A	82.95	N/A

- Mechanical mixer
- 2.0 gpm @ 60psi, 7.6 L/min @ 414kPa



Thermostatic Mixing Valve

Model	Flow	Price	Finish
R3270-MIXLF	N/A	172.10	N/A

- Thermostatic mixing valve
- IAPMO listed to ASSE 1070, ASME A112.1070, CSA B125.70
- 3/8" compression inlets/outlets
- Check valves on inlets
- Minimum flow rate of 0.25 gpm @ 45 psi (1.0 L/min @ 310 kPa)
- Maximum flow rate of 2.5 gpm @ 45 psi (9.5 L/min @ 310 kPa)



Thermostatic Mixing Valve

Model	Flow	Price	Finish
R3070-MIXLF	N/A	172.10	N/A

- Thermostatic mixing valve
- IAPMO listed to ASSE 1070
- 3/8" compression inlets/outlets
- Check valves on inlets
- Min. 0.35 gpm, 1.3 L/min flow rate
- Max. flow of 5.8 gpm, 22 L/min @ 45 psi pressure loss



Thermostatic Mixing Valve

Model	Flow	Price	Finish
R2570-MIXLF	N/A	212.35	N/A

- Thermostatic mixing valve
- IAPMO listed to ASSE 1069, ASSE 1070
- 1/2" copper sweat inlets/outlets
- Check valves on inlets
- Min. 0.34 gpm, 1.29 L/min flow rate
- Max. 11.0 gpm, 42 L/min flow rate

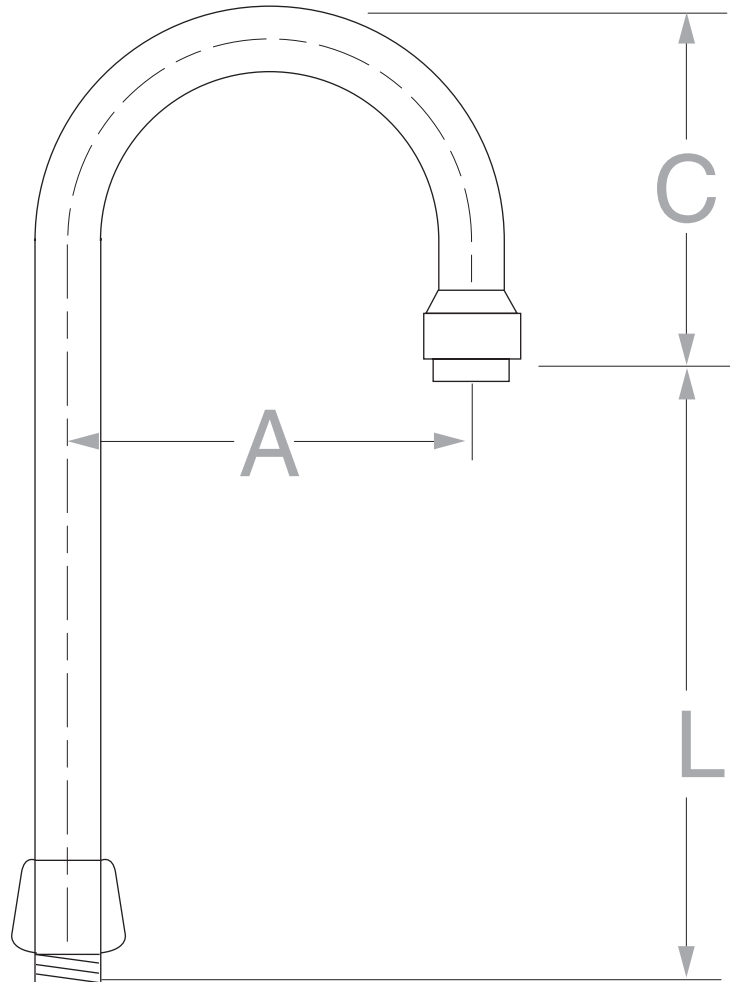

Inserts for Outlets

MODEL	DESCRIPTION		PRICE
060686A	1.9 L/min. (0.5 gpm) Insert (pkg. of 12)	Spray	51.85
060687A	3.8 L/min. (1.0 gpm) Insert (pkg. of 12)	Spray	63.85
060688A	5.7 L/min. (1.5 gpm) Antimicrobial Laminar Flow Insert (pkg. of 12)	Laminar	135.65
060689A	5.7 L/min. (1.5 gpm) Insert (pkg. of 12)	Aerated	35.90

Outlets

FLOW	MODEL	DESCRIPTION		PRICE
1.32 L/min. (0.35 gpm)	061104A	1.32 L/min. (0.35 gpm) Vandal Resistant Outlet (Male)	Spray	33.90
	063256A	1.32 L/min. (0.35 gpm) Spray Outlet M24 x 1 (Male)*	Spray	38.55
1.9 L/min. (0.5 gpm)	060726A	1.9 L/min. (0.5 gpm) Vandal Resistant Outlet (Female)	Spray	39.90
	060666A	1.9 L/min. (0.5 gpm) Outlet (Female)	Spray	17.75
	060667A	1.9 L/min. (0.5 gpm) Outlet (Male)	Spray	17.75
	061203A	1.9 L/min. (0.5 gpm) Vandal Resistant Outlet (Male)	Laminar	35.35
	RP31704	1.9 L/min. (0.5 gpm) Vandal Resistant Outlet (Male)	Spray	34.35
3.8 L/min. (1.0 gpm)	060566A	3.8 L/min. (1.0 gpm) Vandal Resistant Outlet (Male)	Spray	36.55
	060941A	3.8 L/min. (1.0 gpm) Outlet (Female)	Aerated	16.85
	060940A	3.8 L/min. (1.0 gpm) Outlet (Male)	Aerated	17.75
5.7 L/min. (1.5 gpm)	060637A	5.7 L/min. (1.5 gpm) Antimicrobial Laminar Flow Vandal Resistant Outlet (Female)	Laminar	39.90
	060638A	5.7 L/min. (1.5 gpm) Antimicrobial Laminar Flow Vandal Resistant Outlet (Male)	Laminar	39.90
	060639A	5.7 L/min. (1.5 gpm) Vandal Resistant Outlet (Female)	Aerated	24.65
	060640A	5.7 L/min. (1.5 gpm) Vandal Resistant Outlet (Male)	Aerated	24.65
	060641A	5.7 L/min. (1.5 gpm) Outlet (Female)	Aerated	17.75
	060642A	5.7 L/min. (1.5 gpm) Outlet (Male)	Aerated	17.75
	061178A	5.7 L/min. (1.5 gpm) Swivel Outlet M24 x 1 (Male)*	Laminar	35.35
	061118A	5.7 L/min. (1.5 gpm) Antimicrobial Outlet M24 x 1 (Male)*	Laminar	38.55
8.3 L/min. (2.2 gpm)	060719A	8.3 L/min. (2.2 gpm) Outlet (Female)	Aerated	17.75
	060720A	8.3 L/min. (2.2 gpm) Outlet (Male)	Aerated	17.75
	060721A	8.3 L/min. (2.2 gpm) Vandal Resistant Outlet (Female)	Laminar	39.90
	060723A	8.3 L/min. (2.2 gpm) Vandal Resistant Outlet (Female)	Aerated	24.65
	060724A	8.3 L/min. (2.2 gpm) Vandal Resistant Outlet (Male)	Aerated	24.65

Notes: Female thread 55/64" dia - 27 threads/inch. Male thread 15/16" dia - 27 threads/inch.

*(Unless otherwise stated).

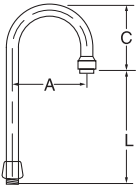

GROUP NO. 1
Regular Gooseneck

Rigid/Swivel Model ONLY	Rigid/Swivel Price	Limited Swing Model ONLY	Limited Swing Price	"A"		"C"		"L"		ADD-ON SUFFIX NO.	SPOUT DESCRIPTION
				MM	IN	MM	IN	MM	IN		
063088A	74.60	063065A	106.00	152	6.0	124	4.9	146	5.8	R4	Gooseneck Spout

Note: Contact customer service for 1500T Series Fixed Spouts.

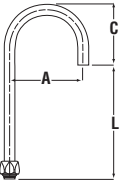

GROUP NO. 2
Smooth End-Flow Control
In Base of Gooseneck Spout
(Available on #7 outlets ONLY)

Rigid/Swivel Model ONLY	Rigid/Swivel Price	"A"		"C"		"L"		ADD-ON SUFFIX NO.	SPOUT DESCRIPTION
		MM	IN	MM	IN	MM	IN		
060878A	77.70	114	4.5	97	3.8	178	7.0	R2	Gooseneck Spout w/FC
060872A	83.95	152	6.0	117	4.6	152	6.0	R4	Gooseneck Spout w/FC
060875A	98.80	229	9.0	155	6.1	178	7.0	R7	Gooseneck Spout w/FC

Note: Contact customer service for 1500T Series Fixed Spouts.

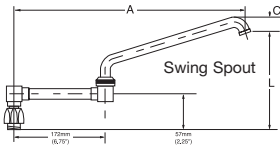

GROUP NO. 4 Double Joint

Rigid/Swivel Model ONLY	Rigid/Swivel Price	"A"		"C"		"L"		ADD-ON SUFFIX NO.	SPOUT DESCRIPTION
		MM	IN	MM	IN	MM	IN		
060269A	63.80	359	14.1	38	1.5	218	8.6	R17	Double Joint Spout

<p>ANGLE VB</p>	Model	"A"		"C"		"L"		Add-On Suffix No.	Price
		MM	Inches	MM	Inches	MM	Inches		
	W6850	152	6.0	173	6.8	137	5.4	R23	186.80

Laboratory Special Replacement Rigid/Swivel Goosenecks (Separate Orders)

<p>REGULAR</p>	Model	"A"		"C"		"L"		Add-On Suffix No.	Price
		MM	Inches	MM	Inches	MM	Inches		
	W6890-2	152	6.0	124	4.9	146	5.8	R4	95.35
	W6890	152	6.0	124	4.9	188	7.4	R5	95.35
	W6890-4	152	6.0	124	4.9	229	9.0	R6	103.90
W6890-5	229	9.0	163	6.4	170	6.7	R7	127.70	

Replacement Swing Spouts (Separate Orders)

SWING SPOUT REPAIR PART			
Model	Description	Add-on Suffix No.	Price
063044A	8" "D" Section Spout	S2	75.75
060452A	6" Tubular Spout	S3	39.45
060269A	8" Tubular Spout	S5	63.80
060455A	11" Tubular Spout	S7	79.55
060456A	14" Tubular Spout	S8	96.30

Model	Description	Price
060003A	C.P. wall flange _____	14.15
060004A	1-1/2" spud flange _____	21.75
060022A	Handle screws & index kit (for 'T' products) includes: _____	67.15
	12 – short screws	
	12 – long screws	
	12 – red indexes	
	12 – blue indexes	
	1 – driver bit	
060026A	Gooseneck spout repair parts kit includes: _____	44.00
	1 – rigid collar	
	6 – retaining rings	
	6 – swivel rings	
	12 – "O" rings	
	1 – spout nut	
060027A	Cross handle w/ screw, red & blue button (for 28T9) _____	41.50
060028A	Pkg. of 12 – set screws _____	17.80
	2 – allen keys	
060030A	Pkg. of 6 – "O" rings _____	51.25
	6 – check units	
060032A	Pkg. of 4 – springs for self-close lever handle w/ L.H. structure _____	58.35
	(cold water side)	
060033A	Pkg. of 4 – springs for self-close lever handle w/ R.H. structure _____	58.35
	(hot water side) and for 5 fluted self-close handles	
060034A	Stem structure complete w/ seat (for 28T9) _____	44.70
060037A	Pkg. of 2 – sani guards _____	37.50
060046A	2-3/4" lever handle w/ screw red and blue index (21B) _____	32.20
060047A	R.H. structure, regular and long renewable seat (21B) _____	22.75
060048A	L.H. structure, regular and long renewable seat (21B) _____	22.75
060049A	Pkg. of 12 – fiber washers _____	22.40
	12 – rubber washers	
060051A	Pkg. of 12 – plug buttons _____	14.25
060052A	Pkg. of 24 – spout "O" rings _____	17.30
060056A	Pail brace complete (for 28T9) _____	117.05
060058A	Integral stop structure complete (for 28T9) _____	47.95
060059A	Pkg. of 12 – "O" rings _____	12.45
060072A	No. 6 x 2" V.P. spanner screws (2) and driver bit _____	37.60
060073A	No. 10 x 2" V.P. spanner screws (4) and driver bit _____	43.65
060074A	Pkg. of 5 – springs _____	19.45
060075A	Pkg. of 5 – plastic handle inserts _____	9.60
060076A	Pkg. of 12 – C.P. cover screws _____	28.95
	1 – driver bit	
060077A	Cover and screw (non hold open model) _____	35.20
060078A	Pkg. of 12 – Cast cap screws _____	19.35
060079A-MMO	Pkg. of 12 – Diaphragms _____	95.65
060081A	Pkg. of 12 – Plug buttons _____	16.45
060082A	Pkg. of 20 – "O" rings _____	21.45
060083A	Pkg. of 12 – Rubber washers _____	21.45
	12 – Fiber washers	
060094A	Brass coupling nut _____	13.50
060115A	3/4" dia. C.P. brass split ring hanger _____	78.10
060117A	1-1/2" dia. C.P. brass split ring hanger _____	94.55
060139A	Seat washers (24/pkg.) _____	14.75
060164A	3" single control lever handle _____	50.50
060198A	Single inlet shank parts kit (for 28T9) _____	43.30
060253A	3/4" x 19-1/2" VB Tube _____	125.15
060264A	Package of 2 sani-guards _____	30.75

Model	Description	Price
060269A	8" Tubular swing spout complete _____	63.80
060271A	3" RCP VB spout complete _____	147.80
060280A	2.2 gpm (8.3 L/min) Female aerator (for pre-1998 gooseneck spouts) _____	17.80
060282A	Check structures complete (2 units, pre-1998) _____	73.30
060302A	Vacuum breaker repair parts kit _____	56.80
060311A	CP insert _____	33.55
060316A	1-1/2" TV elbow _____	83.05
060318A	Flow control inserts only (6/pkg.) _____	32.90
060334A	Battery holder _____	15.00
060341A	Wrench kit for brass renewable seat _____	82.55
060342A	Plug & "O" ring for handle end _____	25.40
060344A	Filter screen for FV (12/pkg.) _____	51.25
060345A	Single shank kit w/ 1.25" offset _____	47.40
060346A	12" flexible braided urinal hose _____	83.50
060354A	Union tail 1" longer _____	61.45
060355A	Union tail 2" longer _____	62.95
060365A	"O" ring kit (6/pkg.) for conn. lav. _____	32.15
060400A	1-1/2" x 10" long VB tube _____	35.20
060401A	1-1/2" x 22-3/4" long VB tube _____	69.65
060402A	3/4" x 11.5" long VB tube _____	61.00
060409A	1-1/4" x 19.6" long trap seal tube _____	147.80
060428A	Deckmount assembly for rigid/swivel spouts _____	74.80
060434A	Metal mounting hardware _____	11.95
060436A	Holddown package _____	15.65
060437A	Holddown package (2 each locknuts, cplg. nuts, lockwashers) _____	11.40
060441A	#3 square drive bit _____	9.65
060444A	Locknut _____	7.95
060445A	CP deck flange _____	15.55
060446A	Fiber washer (12/pkg.) _____	10.70
060452A	6" tubular swing spout _____	39.45
060455A	11" tubular swing spout _____	79.55
060456A	14" tubular swing spout _____	96.30
060462A	1/2" U.A.S. stop _____	88.40
060463A	3/4" spud nut, washers and flange pkg. _____	37.70
060464A	Deck flange _____	11.80
060465A	Rubber washer (12/pkg.) _____	6.90
060466A	Wall flange and set screw (2/pkg.) _____	70.45
060467A	Diverter _____	19.60
060469A	Fiber gasket kit (12/pkg.) _____	24.75
060473A	Optional thin wall trim kit _____	42.40
060479A	Handle & screw kit _____	3.65
060480A	1-1/2" x 3/4" threaded adapter _____	22.85
060481A	3/4" x 16" long rough tube - threaded one end _____	103.50
060487A	2.19" long union tail _____	30.55
060488A	3/4" IP coupling nut - chrome _____	28.65
060489A	1.75" long cover tube _____	12.45
060493A	"O" ring kit (6/pkg.) _____	23.40
060496A	Pre-rinse spring only _____	90.70
060504A	Cover tube & SS wall flange _____	25.25
060506A	Standard adjustable tail _____	43.30
060507A	Poppet pin for watercloset (3/pkg.) _____	23.55
060508A	Poppet pin for urinal (3/pkg.) _____	13.35
060514A	Optional outlet tube - 16" long _____	53.80
060524A	FP repair kit (1999 on) _____	165.75
060543A	4" hooded lever handle pkg. (1 handle, 1 screw, 1 alignment insert, 41.80 red and blue indexes)	

Model	Description	Price	Model	Description	Price
060544A	Alignment insert (12/pkg.)	23.95	060710A	Shower arm trim S/A	47.20
060546A	4" plate and holddown package	85.35	060715A	Straight VB	79.65
060547A	8" plate and holddown package	109.65	060718A	Bracket holder S/A	54.10
060553A	CER-TECK® structure "O" ring kit (24/pkg.)	19.35	060719A	Aerator, female, .859 THD, 2.2 gpm	17.75
060554A	CER-TECK® bottom seal (24/pkg.)	13.15	060720A	Aerator, male, .937 THD, 2.2 gpm	17.75
060564A	Single hole deck gasket	45.90	060721A	Moderator, female, 2.2 gpm	39.90
060566A	VR 1 gpm flow control non-aerating spray outlet	36.55	060723A	VP aerator (female) & key S/A, 2.2 gpm	24.65
060570A	3/4" coupling nut & washers	19.65	060724A	VP aerator (male) & key S/A, 2.2 gpm	24.65
060577A	12" SS cover	182.45	060726A	VP aerator (0.5 gpm), female, S/A	39.90
060583A	Balanced lever handle w/ 1 screw, 1 red and 1 blue index	56.75	060735A	Union nut	14.75
060584A	Mounting hardware (1 gasket, 1 locknut)	34.45	060755A	Cage & P.B. S/A	67.15
060585A	Cover plate and mounting hardware	109.10	060757A	CP 3/8" IP angle VB	79.30
060586A	Flexible SS supply tubes (2/pkg.) 3/8" compression connectors	102.15	060764A	1 x 3/4" MIP X FIP flush bushing	32.20
060590A	Spout w/ adj. bracket - No VB 8"	351.55	060765A	VP aerator key	7.05
060594A	Spout w/ adj. bracket - Ang VB 5 3/4"	210.75	060771A	40VA transformer	77.45
060595A	Straight wall brace assembly	138.75	060777A	1-1/2" TV offset VB & coupling ring	292.55
060596A	Fork wall brace assembly	255.90	060778A	1-1/2" RGH coupling nut S/A	9.90
060599A	3" hooded lever handle & screw	34.65	060779A	Diaphragm & guide S/A	40.95
060602A	4" blade handle w/ screw, 1 red & 1 blue index, alignment insert	79.65	060781A	1 1/2" TV outlet tube & tee S/A	116.65
060637A	Female V.R. 1.5 gpm (5.7 L/min) laminar w/ antimicrobial	39.90	060782A	TECK® 1-1/2" x 10" VB S/A	78.55
060638A	Male V.R. 1.5 gpm (5.7 L/min) laminar w/ antimicrobial	39.90	060783A	TECK® 1-1/2" x 22-3/4" VB S/A	152.50
060639A	Female V.R. 1.5 gpm (5.7 L/min) flow control aerator	24.65	060784A	TECK® 3/4" x 11-1/2" VB S/A	115.25
060640A	Male V.R. 1.5 gpm (5.7 L/min) flow control aerator	24.65	060785A	VB sleeve M.O.	18.05
060641A	Female 1.5 gpm (5.7 L/min) std. flow control aerator	17.75	060791A	Hose end VB S/A	67.60
060642A	Male 1.5 gpm (5.7 L/min) std. flow control aerator	17.75	060793A	30 deg. inst. shower head S/A	254.80
060651A	3 position switch add-on package keyed switch	249.45	060794A	TECK® fluted handle & screw S/A	41.50
060654A	ADA metering handle (plain)	60.35	060798A	Vacuum breaker S/A w/ gasket	56.15
060655A	ADA metering handle (red)	63.70	060799A	Universal TV washer repair kit	25.35
060656A	ADA metering handle (blue)	63.70	060801A	Universal TV handle kit	98.85
060657A	4" deck gasket for 86T ADA metering (3/pkg.)	22.80	060805A	Short spout S/A	212.10
060660A	Checks for 060659A (6/pkg.)	31.20	060809A	Lever handle & screw S/A	25.95
060661A	Holddown pkg. for 87T single hole	6.60	060810A	Handle cage S/A	30.70
060666A	Female std. 0.5 gpm (1.9 L/min) outlet	17.75	060815A	Osc. handle & flange S/A	78.65
060667A	Male std. 0.5 gpm (1.9 L/min) outlet	17.75	060819A	Stream straightener & VP key	45.60
060671A	3/4" NPS solenoid valve	84.35	060820A	Set screw flange S/A	30.85
060673A	10" x 10" stainless cover w/ override	194.60	060822A	PB control unit complete	266.85
060674A	14" x 14" stainless cover w/ override	232.70	060825A	Handle, gland & sleeve S/A	20.50
060676A	Sensor module - washdown urinal	364.65	060841A	Push button & set screw kit	28.50
060679A	Override button	91.50	060843A	Retrofit kit - TECK® exposed	46.10
060680A	Solenoid extension cable 48" (1600T)	28.35	060844A	Repair kit - check/stop	6.95
060681A	Battery holder (1600T) 4 C cells fla	14.40	060845A	Retrofit kit - TECK® concealed	48.35
060683A	24 VAC to 6 VDC converter	59.30	060848A	SC cartridge kit	55.45
060684A	Battery holder (1600T) 4 C cells Sq	21.45	060858A	Vacuum breaker insert	6.65
060686A	0.5 gpm (1.9 L/min) insert only	51.85	060859A	1" UAS stop assembly	173.65
060687A	1.0 gpm (3.8 L/min) insert only	63.85	060862A	1" Conc UAS complete	185.35
060688A	1.5 gpm (5.7 L/min) antimicrobial	135.65	060864A	4" blade handle & screw sub-assembly	48.95
060689A	1.5 gpm (5.7 L/min) insert only	35.90	060865A	6" wrist handle & screw S/A	59.00
060691A	Tube, urinal	27.60	060872A	Flow control gooseneck spout	83.95
060692A	Adj. TV ret. ring	4.25	060875A	Flow control gooseneck spout	98.80
060693A	Oscillating handle	19.05	060878A	Flow control gooseneck spout	77.70
060694A	3/4" C adaptor	18.65	060880A	Handle control unit & bracket	191.75
060696A	1/2" C X MIP adaptor	5.70	060895A	1-1/2" x 16" tube	117.95
060697A	1" copper inlet adaptor	22.30	060896A	1-1/2" x 6.62" L tube	83.60
060704A	20VA transformer	76.10	060897A	Anchor plate & cap S/A	43.65
060705A	CP diverter spout	61.75	060898A	Cover screws for 81T	12.40
060708A	CP 3/8" FIP x 3/8" FIP VB	145.45	060902A	36" solenoid extension cord for 81T	25.85

Model	Description	Price
060906A	Surface mount housing	29.10
060907A	Driver board for 1500T	213.80
060908A	Solenoid holder	3.35
060909A	Screen assembly	2.25
060917A	Lotion w/ moisturizers soap refill	46.05
060918A	Soap dispenser plug-in transformer	98.05
060919A	Soap dispenser 24 VAC to 6 VDC converter	77.45
060923A	Nuts for 1600T recessed (12/pkg.)	49.90
060924A	Retrofit kit for 1000T6 WC w/ 12" frame	778.10
060926A	Retrofit kit for 1000T6 UR w/ 12" frame	778.10
060928A	Retrofit kit for 1000T9 washdown w/ 10" frame	547.65
060931A	E-soap spout assembly metal	536.20
060936A	Motor housing assembly	255.50
060940A	1.0 gpm (3.8 L/min) male aerator	17.75
060941A	Female std. 1.0 gpm (3.8 L/min)	16.85
060947A	3" hooded lever handle PR. H/C-TI w/ screws	56.50
060948A	4" blade handle PR. H/C-TI w/ screws	66.45
060949A	4" hooded lever handle PR. H/C-TI w/ screws	59.55
060958A	Plug-in transformer for DEMD	55.85
060959A	Battery box (6 x 1.5AA) for DEMD	105.40
060960A	Aerator pkg. 0.5 gpm for DEMD	46.50
060961A	Aerator pkg. 1 gpm for DEMD	46.50
060963A	Holddown pkg. for DEMD	42.15
060965A	Sensor kit for DEMD	422.80
060966A	Solenoid valve kit for DEMD	161.75
060967A	Remote control for DEMD	300.40
060968A	Extension cable for DEMD	55.00
060973A	1.5 gpm outlet for 22C w/ wrench flats	23.50
060974A	Hardwire converter (DEMD Series) 24VAC to 9DC	79.65
060983A	Driver board for 860T Series	239.35
060984A	Push button extension cord for 860T series	35.70
060986A	4" SS cover & screws for 860T #6 control box	115.45
060991A	30 deg. Inst. shower head 1.75 gpm	242.55
061011A	30 deg inst shower head - 1.5 gpm	254.80
061014A	Adapter kit (DEMD-800)	11.40
061018A	TECK I parts kit	39.70
061019A	6.0 L (1.6 gal) Adj cap assembly for 81T-manual	87.50
061023A	TECK® cover cap & reg. screw	100.25
061024A	TECK® reg screw & "O" ring assembly	18.95
061025A	Univ TV parts repair kit	69.85
061031A	Gasket for 591T (3/pkg.)	44.20
061037A	0.5 gpm outlet - 500-HDF series	17.25
061038A	Aerator key for 500-HDF series	2.80
061039A	Solenoid valve kit for DEMD WM	170.00
061041A	Sensor kit for DEMD WM	361.80
061043A	Escutcheon kit for DEMD WM	11.20
061045A	Conduit for DEMD WM	35.50
061046A	Battery box for DEMD WM	100.45
061047A	Hardwire converter w/ battery backup	71.25
061051A	T13H handle kit for shower valve	47.95
061052A	Set screw & button	9.65
061054A	Temperature knob, cover & screw	66.85
061055A	Diverter handle, screw & button	68.70
061058A	Diverter valve	276.60
061063A	Replaceable lens	15.85
061069A	Hardwire converter & rigid connection assembly	96.55

Model	Description	Price
061104A	0.35 gpm (1.32 L/min.) V.R. outlet Male	33.90
061118A	Careguard 1.5 gpm laminar male	38.55
061128A	2 ceramic cartridges, hot and cold	57.50
061131A	Extension kit for 060852A diverter valve	20.90
061137A	Wrench for 061134A & R2570-MIX	5.75
061138A	Cover screws for 3rd gen. E-FV (2011)	7.65
061139A	Metal cover for 3rd gen. E-FV (2011)	67.05
061141A	Cover gasket (3/pkg.) for 3rd gen. E-FV (2011)	24.05
061142A	W.C. repair kit for 3rd gen. E-FV (2011)	542.15
061143A	UR repair kit for 3rd gen. E-FV (2011)	542.15
061157A	Spacer pkg. for high rise Prox	24.95
061158A	Spacer pkg. for 4" CS Prox	57.65
061159A	4" Deck plate and holddown pkg.	85.35
061160A	8" Deck plate and holddown pkg.	109.60
061164A	Sensor DEMD-201/211	404.55
061165A	Sensor DEMD-101/111	404.55
061166A	Solenoid valve kit DEMD-101/11 1/201/211	172.20
061168A	DEMD 101/111 hardwire converter	31.15
061169A	6.0 L (1.6 gal) Adj cap assembly for E-81T & 1600T6	395.45
061171A	Tubular spout for 28P44	34.25
061172A	Gooseneck spout for 28P49	42.10
061173A	Angular spout for 28P42	46.85
061175A	HDF Proximity® spacer package	24.50
061178A	1.5 gpm laminar swivel outlet for DEMD	35.35
061201A	4 x 4 x 4 Box w/ bushing & guard	137.10
061203A	Vandal resistant male 0.5 gpm laminar outlet	35.35
061206A	Proximity® clip-on sensor module	147.80
061209A	Wallmount sensor trim kit (red)	835.45
061210A	Wallmount sensor trim kit (blue)	835.45
061233A	Metering urinal cartridge	61.35
061237A	Bedpan diverter assembly	651.75
061241A	Urinal push button metering retrofit kit	135.20
061245A	Oscillating handle metering retrofit kit	135.50
061246A	Oscillating handle and bonnet kit	40.45
061252A	Dual driver board H ₂ Optics® and Proximity®	205.95
061255A	Battery holder - square 4-AA version	17.40
061256A	36" extension cable (H ₂ Optics®/Proximity® combo board)	59.40
061258A	Holddown pkg	44.50
061259A	Proximity® dual board grounding wire	46.30
061264A	Spout plate 4" x 4"	157.50
061266A	Pkg. of 3 - 0.5 gpm laminar outlet	105.90
061267A	Pkg. of 3 - 1.0 gpm laminar outlet	105.90
061268A	Pkg. of 3 - 1.5 gpm laminar outlet	109.05
061269A	4" plate assembly - Chrome	85.90
061269BL	4" plate assembly - Matte Black	104.00
061269SS	4" plate assembly - SS	104.00
061272A	Sensor module for WC - WMs & 1600T	364.65
061273A	Sensor module for UR - WMs & 1600T	364.65
061296A	Pkg. of 3 - 2.2 gpm laminar outlets	105.65
061297A	590-HDF 3rd gen driver board	210.95
061298A	590-HDF 3rd gen extension cable	43.55
061305A	4" Rectangular plate assembly	102.55
061305SS	4" Rectangular plate assembly	113.00
061307A	0.35 gpm spray outlet (3/pkg)	79.75
061310A	DESD-750 hardwire converter	47.60
061311A	DESD-750 remote control	99.95

Model	Description	Price	Model	Description	Price
061315A	Sensor/controller for DEMD-611	294.00	063033A	Spout adapter & fiber gasket	40.00
061317A	Sensor kit for DESD-750	287.35	063034A	Shank & washer kit	5.15
061319A	Soap dispenser pump assembly	141.45	063041A	Long renewable seat	5.15
061320A	Battery box for DESD-750	112.35	063044A	8" wallform swing spout	75.75
061322A	Push button/cage/button cap nut	67.15	063046A	Hose end adapter	16.85
061323A	WC diaphragm/guide	38.95	063049A	Escutcheon & fiber washer	44.00
061324A	UR diaphragm/guide	38.95	063054A	CER-TECK® retrofit pkg.	47.95
061325A	6.0 L (1.6 gal) Adj cap assembly for 81TBTA-MMO	395.45	063055A	Gooseneck spout adapter and gasket	33.10
061326A	Solar cell assembly - DEMD	127.85	063056A	Swing spout adapter and gasket	33.10
061327A	Battery pack - DEMD	10.00	063057A	C Series widespread renewable seat	22.55
061328A	Solenoid - DEMD	91.15	063065A	Limited swing gooseneck	106.00
061329A	Holddown pkg - DEMD	204.65	063084A	Gooseneck spout adapter pkg.	30.55
061330A	Solar PCB/sensor - DEMD	127.00	063087A	Gooseneck spout	68.40
061331A	Filter screen for solar - DEMD	3.80	063088A	Gooseneck spout	74.60
061332A	Hose for DEMD-320LF	140.05	063089A	Gooseneck spout	79.90
061333A	Hoses for DEMD-321LF	194.95	063090A	Gooseneck spout	79.90
061334A	Aerator outlet for DEMD-320/321LF	7.65	063091A	Gooseneck spout	88.65
061336A	0.5 L (0.125 gal) fixed cap assembly for 81T manual FV	87.50	063101A	RHCP brass TUF-TECK® structure kit	30.75
061337A	1.9 L (0.5 gal) fixed cap assembly for 81T manual FV	87.50	063102A	LHCP brass TUF-TECK® structure kit	30.75
061340A	1.9 L (0.5 gal) Adj. cap assembly for 81T manual FV	87.50	063103A	Deckmount gooseneck spout	145.70
061341A	0.5 L (0.125 gal) fixed cap assembly for 81T & 1600T6	395.45	063105A	Offset shank & rubber washer	166.00
061342A	1.9 L (0.5 gal) fixed cap assembly for 81T & 1600T6	395.45	063106A	Check structure, gasket & cap	210.10
061343A	4.2 L (1.1 gal) fixed cap assembly for 81T & 1600T6	395.45	063107A	3" hooded lever handle, CER-TECK®	83.35
061344A	4.8 L (1.27 gal) fixed cap assembly for 81T & 1600T6	395.45	063108A	4" blade handle w/ sani guards, CER-TECK®	116.50
061345A	6.0 L (1.6 gal) fixed cap assembly for 81T & 1600T6	395.45	063116A	CP adapter	10.00
061346A	1.9 L (0.5 gal) Adj. cap assembly for 81T & 1600T6	395.45	063120A	Escutcheon & fiber washer swing spout inline	84.30
061351A	1.9 L (0.5 gal) Adj. cap assembly for 83T manual FV	118.65	063121A	Retrofit pkg. 4" hooded lever CER-TECK®	89.20
061352A	13 L (3.4 gal) Adj. cap assembly for 81T retrofit kits	395.45	063125A	Single post cast Proximity™	410.15
061353A	0.5 L (0.125 gal) fixed cap assembly for 81T-MMO	395.45	063126A	4" cast Proximity™	517.15
061354A	4.2 L (1.1 gal) fixed cap assembly for 81T-MMO	395.45	063129A	590 HDF Proximity™ Series spout assembly	295.75
061355A	4.8 L (1.27 gal) fixed cap assembly for 81T-MMO	395.45	063130A	Mixing tee & checks for 87T Series	102.55
061356A	1.9 L (0.5 gal) Adj. cap assembly for 81T-MMO	395.45	063135A	Screwdriver stop repair kit	13.70
061365A	RP43381 w/060710A (#2 head kit for T13H & T17TH)	112.15	063136A	Thermostatic mixing valve 3/8"	196.00
061366A	52672-15-BG w/060710A (#3 head kit for T13H & 860T)	50.95	063140A	Adapter w/ flow control (1.5 gpm)	9.40
061369A	Springs for #8 self-close lever handles (1LH, 1RH)	28.05	063164A	Check Valves for R2570-MIXLF	14.00
061371A	Wrist Blade (#5) handle kit (2 handles, screws, saniguard, indexes)	114.45	063173A	Hose assembly & insulated grip	172.30
061372A	1 L soap bottle for DESD-750/751	12.50	063178A	Foot pedal cartridge	108.10
061373A	Mounting bracket for 1 L soap bottle - DESD-750/751	32.95	063180A	10 mm to 3/8" compression kit	63.80
061374A	1.9 L (0.5 gal) fixed cap assembly for E-81T-MMO	395.45	063183A	Single hole mount turret assembly	433.45
061375A	4.2 L (1.1 gal) fixed cap assembly for 81T manual FV	83.20	063185A	Single hole mount turret assembly	420.80
061376A	UR guide assembly (MMO, 2018)	37.00	063188A	Single hole mount turret assembly	420.80
062007A	Brass seat	18.90	063193A	Single hole mount turret assembly	414.25
062025A	Washer for 3rd gen. WC (3/pkg.)	18.90	063196A	VR 1.5 gpm WM shower head complete	254.80
062032A	3/8" x 3/8" compression polymer hose	21.35	063204A	Single hole mount turret assembly	420.80
063000A	RH CER-TECK® cartridge	28.65	063207A	Single hole mount turret assembly	420.80
063001A	LH CER-TECK® cartridge	28.65	063210A	590T spout assembly	453.75
063002A	Structure repair kit	47.00	063211A	591T spout assembly	453.75
063005A	R.H. TECK® structure kit	34.40	063214A	VR 2.0 gpm WM shower head complete	254.80
063006A	L.H. TECK® structure kit	34.40	063219A	Slip on spout complete 1.5 gpm	248.65
063007A	WM gooseneck spout	230.15	063220A	Slip on spout rough in box	69.15
063013A	Renewable seats (12/pkg.)	25.85	063223A	Pkg. of 2 - coupling nuts	9.05
063019A	Pre-rinse retrofit kit	660.55	063230A	590-HDF 3rd gen spout assembly	287.30
063024A	Tee assembly	31.55	063234A	Solenoid kit for DEMD-86 (2015)	157.05
063028A	Cast spout / hole	170.80	063246A	0.35 gpm spout 630TP-chrome	266.30
063029A	Center body - 10-1/2" long	92.15	063247A	0.5 gpm spout 630TP-chrome	265.20
063032A	Center body - 6-1/2" long	45.20	063248A	1.5 gpm spout 630TP-chrome	262.35

Model	Description	Price
063250A	Thermostatic cartridge assembly	418.30
063251A	Solenoid for DEMD-611	108.40
063253A	Threadlocker 0.5 ml (loctite)	15.65
063254A	Hold down package	11.30
063255A	0.5 GPM VR spray cache outlet	9.85
063256A	0.35 gpm spray outlet M24X1 for DEMD series	38.55
063257A	3/4" solenoid w/adaptors for 3/8" compression	86.75
063258A	Surface box (less driver board and battery holder)	109.40
063259A	Solar flush valve cover & set screw	54.65
063260A	Solar flush valve module & screws	151.05
063261A	Solar flush valve sensor & screws	617.00
063262A	Solar flush valve locking ring	30.15
063264A	1.0 GPM laminar outlet for DEMD-611	44.25
063266A	Plug-in power supply	52.50
063267A	Hardware filter w/20VA open frame transformer	121.05
063268A	Battery backup assembly for surface box (#0)	71.25
063269A	Battery backup assembly for recessed boxes (#1, #8)	71.25
063270A	Hardwire converter for open frame transformer	59.30
063271A	Hardware filter for Proximity® installations	45.00
063272A	Ganging wire (5 ft.)	40.40
063273A	Universal controller (w/barrel plug)	205.95

Model	Description	Price
063274A	Surface mount box housing w/solenoid	109.40
063275A	Proximity® 2.0 sensor cable	147.80
063276A	Proximity® 2.0 retrofit kit for H/W recessed box	316.90
063277A	Spray head and hold open ring (1.05 gpm)	186.80
068030A	Pol DW valve handle	7.70
068032A	Tail	12.40
068041A	CP (ball valve) nozzle	18.85
068047A	Tail & locknut pkg.	18.95
068049A	CP FE nozzle	17.00
068057A	(CW) cold water index button (3/pkg.)	17.80
068062A	(HW) hot water index button (3/pkg.)	17.80
068072A	(AIR) air index button (3/pkg.)	17.80
068074A	(GAS) gas index button (3/pkg.)	17.80
068092A	3/8" cplg. nut & 1/4" tail conn. pkg.	20.30
068106A	Repair DW stem kit	60.05
068128A	W6629 repair kit	93.05
H78	LG blade handle w/ screw-moni	42.65
W6850	Angle VB gooseneck	186.80
W6878	Flow control aerator and spout end adapter, 3/8" F.I.P. inlet	21.85
W6890	Rigid/swivel gooseneck	95.35
W6971	2-arm metal handle w/ screw	28.05

For more information, write or call the Delta Faucet Sales Representative Agency nearest you.

<p>ALABAMA</p> <p>Will & Pierce Agency 6612 Pinehill Road Daphne, AL 36526 (251) 621-1550 Fax (251) 621-3036</p>	<p>FLORIDA</p> <p>Carr Company 6000 Park of Commerce Blvd., Suite A Boca Raton, FL 33487 (800) 578-CARR (2277) Fax (561) 997-2633</p> <p>Carr Company 6306 Benjamin Rd., Suite 614 Tampa, FL 33634 (813) 901-8552 Fax (813) 901-8555</p> <p><i>Panhandle Counties</i></p> <p>Will & Pierce Agency 6612 Pinehill Road Daphne, AL 36526 (251) 621-1550 Fax (251) 621-3036</p>	<p>KANSAS</p> <p>Summit Sales, Inc. 1803 E. 123rd Terrace Olathe, KS 66061 (913) 791-9599 Fax (913) 791-9598</p>	<p>MONTANA</p> <p>Rocky Mountain Sales, Inc. 150 Capital Dr., #420 Golden, CO 80401 (303) 289-4191 Fax (303) 286-9069</p>	<p>NORTH CAROLINA</p> <p>Smith & Stevenson Co., Inc. P.O. Box 240009 Charlotte, NC 28224 (704) 525-3388 Fax (704) 888-6141</p>	<p>TEXAS</p> <p>Southwest Sales Inc. 9705 Burnet Road, Suite 506 Austin, TX 78758 (972) 881-8757 Fax (972) 881-2115</p> <p><i>Counties of El Paso, Culberson, Reeves, Hudspeth, Jeff Davis, Pecos, Brewster, Terrell & Presidio</i></p> <p>W W Sales Company 3500 Richmond Dr., N.E., Suite A Albuquerque, NM 87107 (505) 878-0636 Fax (505) 878-0638</p>
<p>ALASKA</p> <p>Synergy Sales NW, LLC 7074 S 220th St. Kent, WA 98032 (425) 502-7944 Fax (425) 502-9026</p>	<p>GEORGIA</p> <p>Pulley & Associates 430 Lovena Drive S.E., Suite 200 Marietta, GA 30067 (770) 425-0706 Fax (770) 428-3934</p>	<p>KENTUCKY</p> <p>BDA-KY, LLC 11321 Decimal Drive Louisville, KY 40299 (502) 243-0142 Fax (502) 243-0176</p>	<p>NEBRASKA</p> <p><i>Western Region</i></p> <p>Rocky Mountain Sales, Inc. 150 Capital Dr., #420 Golden, CO 80401 (303) 289-4191 Fax (303) 286-9069</p> <p><i>Central/Eastern Region</i></p> <p>Mid America Sales Group, Inc. 2001 SE 44th Court Grimes, IA 50111 (515) 986-9446 Fax (515) 986-3552</p>	<p>NORTH DAKOTA</p> <p>NCS Corp. 7440 W. 78th Street Bloomington, MN 55439 (952) 941-4464 Fax (952) 941-0396</p>	<p>UTAH</p> <p>Mountain West Marketing 3147 North Highway 89 Pleasant View, UT 84404 (801) 782-0100 Fax (801) 782-2021</p>
<p>ARIZONA</p> <p>Bobier Sales, Inc. 2125 E. Jones Avenue Phoenix, AZ 85040 (602) 304-0001 Fax (602) 304-0005</p>	<p>HAWAII</p> <p>J & B Marketing 119 Merchant Street Suite 610 Honolulu, HI 96813 (808) 548-2070 Fax (888) 965-9604</p>	<p>LOUISIANA</p> <p>Will & Pierce Agency - West 13405 Seymour Meyers Blvd. Unit 20 Covington, LA 70447 (985) 273-0229 Fax (985) 400-2498</p>	<p>NEVADA</p> <p><i>Northern Region</i></p> <p>Mega Western Sales North 81 Wright Brothers Ave. Livermore, CA 94551 (510) 385-5014 Fax (310) 323-9421</p> <p><i>Southern Region</i></p> <p>Mega Western Sales South 8737 Dice Rd. Santa Fe Springs, CA 90670 (310) 323-7900 Fax (310) 323-9421</p>	<p>OHIO</p> <p>Libb Company, Inc. 7860 N. Central Dr. Lewis Center, OH 43035 (740) 549-1516 Fax (740) 548-0985</p>	<p>VERMONT</p> <p>Futura Sales 1451 Concord St. Suite 6 Framingham, MA 01701 (508) 788-9257 Fax (508) 788-9258</p>
<p>ARKANSAS</p> <p>Rich Sales, Inc. P.O. Box 241010 Little Rock, AR 72223 (501) 868-9711 Fax (501) 868-9787</p>	<p>IDAHO</p> <p><i>Southern Region</i></p> <p>Mountain West Marketing 3147 North Highway 89 Pleasant View, UT 84404 (801) 782-0100 Fax (801) 782-2021</p>	<p>MAINE</p> <p>Futura Sales 1451 Concord St. Suite 6 Framingham, MA 01701 (508) 788-9257 Fax (508) 788-9258</p>	<p>NEW HAMPSHIRE</p> <p>Futura Sales 1451 Concord St. Suite 6 Framingham, MA 01701 (508) 788-9257 Fax (508) 788-9258</p>	<p>OKLAHOMA</p> <p>NSC Marketing Group 46 East Hill St. Oklahoma City, OK 73105 (405) 602-2800 Fax (405) 602-2824</p>	<p>WEST VIRGINIA</p> <p><i>Northeastern Region</i></p> <p>Barger & Associates 101 Production Dr., Suite 104 Yorktown, VA 23693 (757) 873-4574 Fax (757) 873-9530</p>
<p>CALIFORNIA</p> <p><i>Northern Region</i></p> <p>Mega Western Sales North 81 Wright Brothers Ave. Livermore, CA 94551 (510) 385-5014 Fax (310) 323-9421</p> <p><i>Southern Region</i></p> <p>Mega Western Sales South 8737 Dice Rd. Santa Fe Springs, CA 90670 (800) 304-3909 Fax (310) 323-9421</p>	<p>MARYLAND</p> <p>Barger and Associates 101 Production Dr., Suite 104 Yorktown, VA 23693 (757) 873-4574 Fax (757) 873-9530</p>	<p>MASSACHUSETTS</p> <p>Futura Sales 1451 Concord St. Suite 6 Framingham, MA 01701 (508) 788-9257 Fax (508) 788-9258</p>	<p>NEW JERSEY</p> <p><i>Northern Region</i></p> <p>Althem, Inc. 1040 Wilt Ave. 2nd Floor Ridgefield, NJ 07657 (201) 871-0500 Fax (201) 871-0314</p> <p><i>Southern Region</i></p> <p>Rich Tomkins Company, Inc. 235 Bridgewater Road Ashton, PA 19014 (610) 859-3552 Fax (610) 859-6080</p>	<p>PENNSYLVANIA</p> <p><i>Eastern Region</i></p> <p>Rich Tomkins Company, Inc. 235 Bridgewater Road Ashton, PA 19014 (610) 859-3552 Fax (610) 859-6080</p> <p><i>Western Region</i></p> <p>Triangle Sales 412 Darby Way, Suite 3 Bridgeville, PA 15017 (412) 257-2300 Fax (412) 257-2303</p>	<p>WASHINGTON</p> <p>Synergy Sales NW, LLC 7074 S 220th St Kent, WA 98032 425-502-7944 Fax (425) 502-9026</p>
<p>COLORADO</p> <p>Rocky Mountain Sales, Inc. 150 Capital Dr., #420 Golden, CO 80401 (303) 289-4191 Fax (303) 286-9069</p>	<p>ILLINOIS</p> <p><i>Northern Region</i></p> <p>Synergy Sales NW, LLC 7074 S. 220th St. Kent, WA 98032 (425) 502-7944 Fax (425) 502-9026</p> <p><i>Southern Region</i></p> <p>Summit Sales, Inc. - East 29202 Cotton Road Foristell, MO 63348 (913) 791-9599 Fax (913) 791-9598</p>	<p>MICHIGAN</p> <p>Burke Agency Inc. 2605 E. Oakley Park Rd., Suite A Commerce Twp, MI 48390 (248) 669-2800 Fax (248) 669-3310</p>	<p>NEW MEXICO</p> <p>W W Sales Company 3500 Richmond Dr., N.E., Suite A Albuquerque, NM 87107 (505) 878-0636 Fax (505) 878-0638</p>	<p>RHODE ISLAND</p> <p>Futura Sales 1451 Concord St. Suite 6 Framingham, MA 01701 (508) 788-9257 Fax (508) 788-9258</p>	<p>WEST VIRGINIA</p> <p>Barger and Associates 101 Production Dr., Suite 104 Yorktown, VA 23693 (757) 873-4574 Fax (757) 873-9530</p> <p>Triangle Sales 412 Darby Way, Suite 3 Bridgeville, PA 15017 (412) 257-2300 Fax (412) 257-2303</p>
<p>CONNECTICUT</p> <p>Futura Sales 1451 Concord St. Suite 6 Framingham, MA 01701 (508) 788-9257 Fax (508) 788-9258</p>	<p>INDIANA</p> <p>BDA-IN 8100 E 106th St., Suite 210 Fishers, IN 46038 (317) 867-3799 Fax (317) 867-5949</p>	<p>MINNESOTA</p> <p>NCS Corp. 7440 W. 78th Street Bloomington, MN 55439 (952) 941-4464 Fax (952) 941-0396</p>	<p>NEW YORK</p> <p><i>NY Metro and Long Island</i></p> <p>Althem, Inc. 1040 Wilt Ave. 2nd Floor Ridgefield, NJ 07657 (201) 871-0500 Fax (201) 871-0314</p> <p><i>Upstate Region</i></p> <p>Twin "D" Associates, Inc. 1184 Troy Schenectady Rd., Suite 101 Latham, NY 12110 (518) 862-9500 Fax (518) 464-3410</p>	<p>SOUTH CAROLINA</p> <p>Smith & Stevenson Co., Inc. P.O. Box 240009 Charlotte, NC 28224 (704) 525-3388 Fax (704) 888-6141</p>	<p>WISCONSIN</p> <p><i>Eastern Region</i></p> <p>Midwest Sales & Marketing 530 Progress Drive Hartland, WI 53029 (800) 246-8440 Fax (800) 246-6464</p> <p><i>Western Region</i></p> <p>NCS Corp. 7440 West 78th Street Bloomington, MN 55439 (952) 941-4464 Fax (952) 941-0396</p>
<p>DELAWARE</p> <p><i>Sussex County</i></p> <p>Barger and Associates 101 Production Dr., Suite 104 Yorktown, VA 23693 (757) 873-4574 Fax (757) 873-9530</p> <p>Rich Tomkins Company, Inc. 235 Bridgewater Road Ashton, PA 19014 (610) 859-3552 Fax (610) 859-6080</p>	<p>IOWA</p> <p>Mid America Sales Group, Inc. 2001 SE 44th Court Grimes, IA 50111 (515) 986-9446 Fax (515) 986-3552</p>	<p>MISSISSIPPI</p> <p>Will & Pierce Agency - West 13405 Seymour Meyers Blvd. Unit 20 Covington, LA 70447 (985) 273-0229 Fax (985) 400-2498</p>	<p>MISSOURI</p> <p><i>Eastern Region</i></p> <p>Summit Sales Inc. - East 29202 Cotton Road Foristell, MO 63348 (913) 791-9599 Fax (913) 791-9598</p> <p><i>Western Region</i></p> <p>Summit Sales Inc. - West 1803 East 123rd Ter. Olathe, KS 66061 (913) 791-9599 Fax (913) 791-9598</p>	<p>SOUTH DAKOTA</p> <p><i>Western Region</i></p> <p>Rocky Mountain Sales, Inc. 150 Capital Dr., Suite 420 Golden, CO 80401 (303) 289-4191 Fax (303) 286-9069</p> <p><i>Central/Eastern Region</i></p> <p>NCS Corp. 7440 W. 78th Street Bloomington, MN 55439 (952) 941-4464 Fax (952) 941-0396</p>	<p>TENNESSEE</p> <p>Pulley & Associates 430 Lovena Drive S.E., Suite 200 Marietta, GA 30067 (770) 425-0706 Fax (770) 428-3934</p>
<p>DISTRICT OF COLUMBIA</p> <p>Barger and Associates 101 Production Dr., Suite 104 Yorktown, VA 23693 (757) 873-4574 Fax (757) 873-9530</p>					

Unparalleled Support

Delta Faucet Company has an office in virtually every major city in the United States. Delta® agencies are staffed nationwide with more than 400 highly experienced sales professionals who live and work in your market to meet your needs at a local level promptly and efficiently. Your local representative will assume responsibility for communication throughout the supply chain, becoming an extension of your business to ease everyday tasks and troubleshoot. Your agency is readily available to assist with customer service, stocked warranty and service parts, provisioning and training, literature and displays. This level of advanced service is brought to you only by Delta Faucet Company.



WARRANTY

These Delta® products are warranted to the original consumer purchaser or commercial user. Please refer to the “Limited Warranty” enclosed with each Delta product for specific details. Additional copies are available upon request.

RETURNED GOODS

Merchandise MAY NOT be returned for credit or replacement without prior inspection and written authorization from Delta Faucet Company (DFC). Any unauthorized return of products is expressly prohibited. A handling charge of 50% will be assessed against anyone attempting to return merchandise without prior authorization. Only product purchased directly from Delta Faucet Company by a wholesaler will be authorized for return. NO EXCEPTIONS.

WARRANTY RETURNS

A full wholesale price credit will be issued to authorized Delta Faucet wholesaler customers for returned merchandise that is defective as described in the warranty. The defective merchandise must be shipped freight prepaid by the least costly method of shipment and the freight cost of such shipment will be added to the price credit. If a replacement is made rather than a credit issued, Delta Faucet Company will ship the replacement freight prepaid. Product returned as defective that is found to be misused, abused, modified or otherwise NOT DEFECTIVE will receive credit at scrap value only.

OTHER RETURNS

All other returns will be handled in accordance with the then-current DFC Return Policy for Non-Defective Faucets, copies of which are available upon request.

PRICES

All prices and specifications of models are subject to change without notice. Orders will be invoiced at the prices prevailing at time of shipment.

NOTE

All orders are subject to all applicable DFC policies in effect at the time of order.

These Terms of Sale are subject to change without notice.

RETURN ADDRESS

All returns are to be sent to the following address:

Delta Faucet Company
3445 Ridgecrest Road Extended
Jackson, Tennessee 38305
Attn: Returned Goods Department

ActivTouch, Allora, Ara, Arctic, Arzo, Ashlyn, Brilliance, CER-TECK, Compel, Delta, DURAMOUNT, Esque, Essa, EZ Anchor, Foundations, HDF, H2Okinetic, H2Optics, HydraChoice, HydroRain, InnoFlex, In2ition, Jetted Shower XO, Lahara, Leland, MagnaTite, Mateo, Monitor, MultiChoice, Palm, Palo, Pilar, Pivotal, PowerDrench, Proximity, ShieldSpray, SpotShield, Teck, TempAssure, TempSense, Temp2O, Tesla, Touch2O, Touch2O.xt, Touch-Clean, Trinsic, Tuf-Teck, Venetian Bronze, Vero, Victorian, Windemere, Woodhurst and Zura are registered trademarks of Delta Faucet Company.

Addison, Botanical, Broderick, Cassidy, Champagne Bronze, Collins, Décor Assist, DIAMOND, Dorval, Dryden, eFlow, Emerge, Fundamentals, Fuse, Grail, Innovations, Linden, Multi-Flow, Orleans, Quick-Snap, Scald-Guard, Signature, Stryke, Talbott, Tract-Pack, Waterfall and XO Jet Module are trademarks of Delta Faucet Company.

Celcon® is a registered trademark of CNA Holdings, LLC.



THERE'S MORE TO SEE ON DELTAFAUCET.COM

The Commercial section has been added on deltafaucet.com.

You can now find all things related to Delta® Commercial in the Commercial tab and have access to all commercial products, brochures, technical documents, and support information. All in one place.

Scan the QR code to visit the website.



The new commercial section of the website includes all Delta® Commercial's relevant information including:

- Commercial Product Assortment
- List Pricing
- Technical Documents: Spec Sheets, M&I, etc.
- Commercial Innovations and Landing Pages
- Catalogs, Brochures and Sell Sheets

Delta Commercial Technical Service
1-877-509-2680

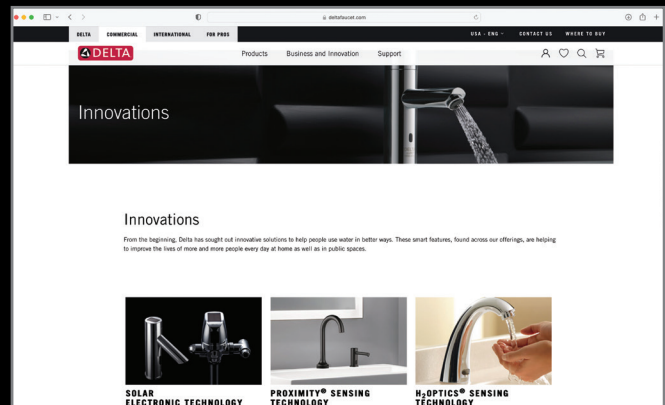
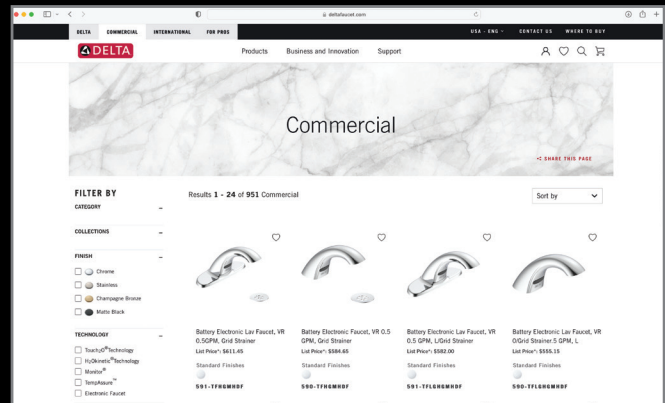
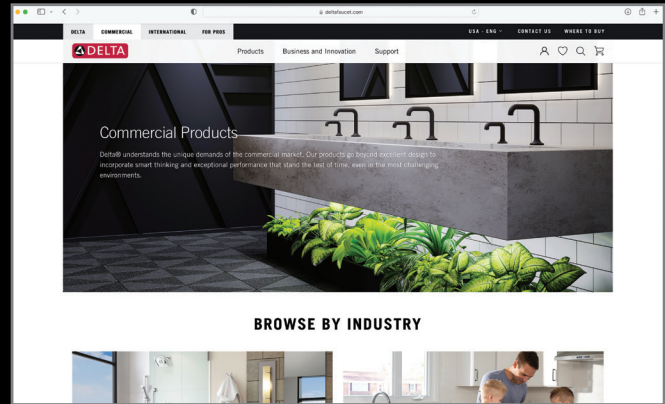



see what Delta can do™

A MASCO COMPANY

Masco Canada Limited
350 S. Edgeware Rd.
St. Thomas, Ontario N5P 4L1

Delta Faucet Company
55 E. 111th St., P.O. Box 40980
Indianapolis, IN 46280

deltafaucet.com
800.345.DELTA (3358)

Delta Commercial Technical Service
877.509.2680

©2023 Delta Faucet Company
MKT-23-013 09/23