

# Parts & Accessories

## Catalog

## Catálogo de Piezas y Accesorios

1 9 9 6 - 1 9 9 7

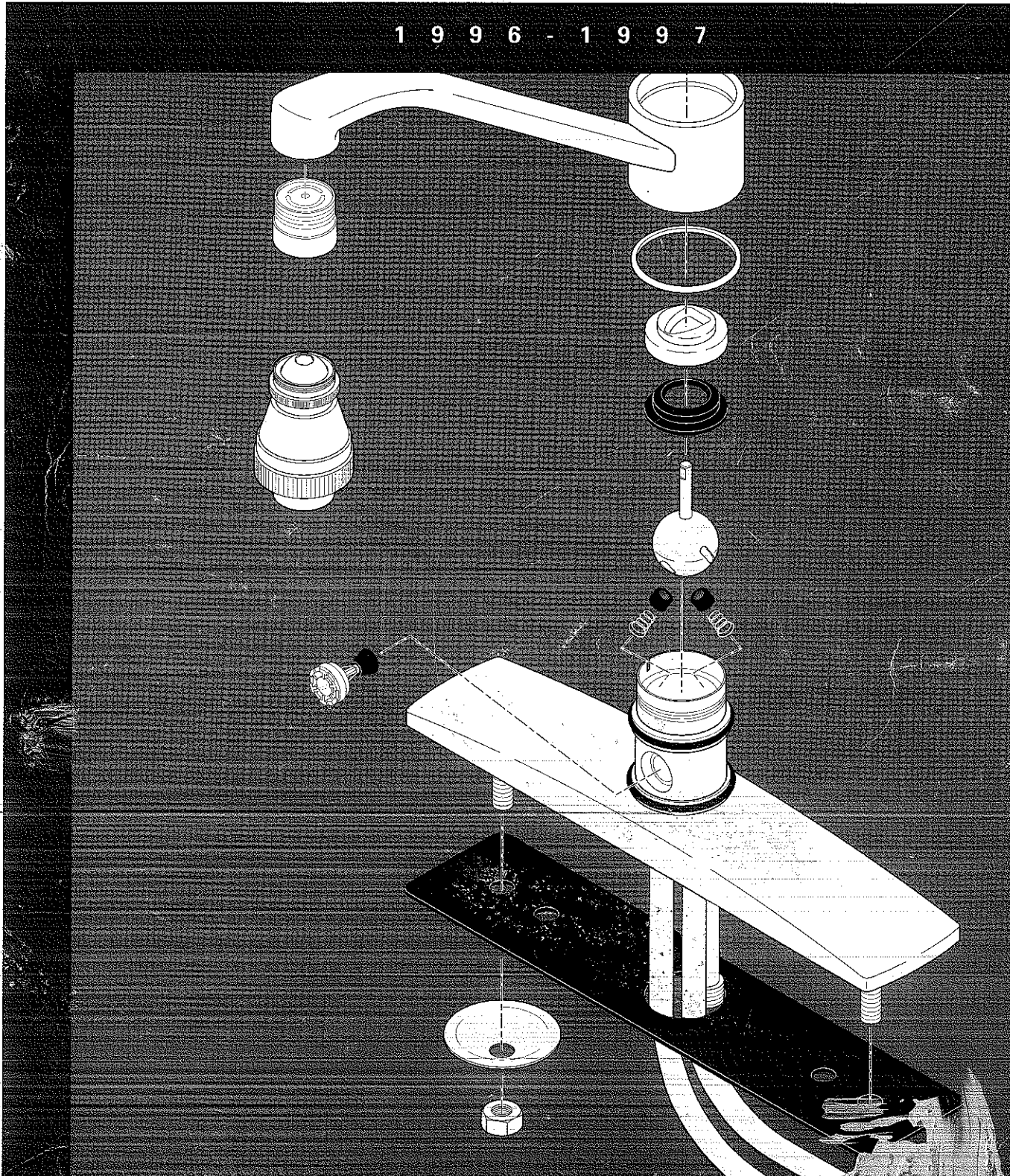

# INDEX/INDICE

SERIES	PAGE/PÁGINA	SERIES	PAGE/PÁGINA	SERIES	PAGE/PÁGINA
33	78, 79	603*	55	2527-HDF	50
44	78, 79	604*	55	2530	29
100	2	606	54	2567	30
100-D	2	611	54	2576*	31
101	4	612	54	2581*	32
110	2	621	54	2593-HDF	33
120	5	622	54	2599-HDF	33
130*	12	623*	55	2600	62, 63
150	6	624*	55	2653	64, 65
151	7	635	54	2683	64, 65
172	8	636	54	2702*	66
173	8	637*	55	2708	68
174	8	638*	55	2710	69
175	4	641	54	2711	69
200	9	642	54	2714	76
275	9	643*	55	2730	70
300	3	644*	55	2731	70
300-D	3	701-HDF	50	2746*	66
350	6	710-WFHDF	52	2750	68
400	2	711-WFHDF	52	2767	71
400-D	2	750	49	2768	71
420	5	752	49	2770	72
430*	12	1300	56, 57	2771	72
450	6	1400	56, 57	2780	73
451	7	1500	58, 59	2781	73
460*	10	1600*	60, 61	2800	62, 63
461*	10	2100	14	2885	64, 65
462	11	2102	14	2897	64, 65
466	11	2121	47	3501-HDF	34
500	25	2123	47	3504	36
501	25	2147	16, 17	3507-WFHDF	51
502	24	2167	15	3509-HDF	34
503	24	2170	22	3514-WFHDF	51
504	24	2171	22	3517-WFHDF	51
505	25	2172	22	3523	36
511	25	2174	18, 19	3524	36
515	25	2176	18, 19	3530	42
516	25	2177	23	3541-HDF	35
520	25	2274	20, 21	3543	37
522	24	2276	20, 21	3544	37
523	25	2302	48	3545	37
524	24	2303-HDF	48	3545-HDF	35
525	25	2400	14	3548-HDF	35
550	26	2402	14	3549-HDF	35
552	26	2447	16, 17	3551-HDF	35
560	46	2467	15	3567	38
561*	46	2474	18, 19	3576*	39
562	46	2476	18, 19	3577	40
563*	46	2500	28	3579-HDF	53
570	27	2502	28	3583	41
575	27	2507-HDF	50	3584	41
601	54	2517-HDF	50	4530	43
602	54	2520	28	21460*	13

\*Discontinued Series/Series Descontinuados

## SECTION/SECCION

	PAGE(S)/PÁGINA(S)
Handle Suffix Chart/Tabla de Designación de Sufijos de Manijas y Características	19
Kitchen Faucets/Fregaderos	2 - 21
Bar Faucets/Bares	22 - 23
Lavatory Faucets/Lavamanos	24 - 43
Lavatory Drain Assemblies/Ensamblajes para Desagües Automáticos para Lavamanos	44 - 45
Specialty Faucets/Llaves de Especialidad	46 - 53
Tub & Shower/Bañeras y Regaderas	54 - 66
Hand Showers & Accessories/Regaderas de Mano y Accesorios	66
Tub & Shower Accessories/Accesorios de Bañeras y Regaderas	67
Deck/Ledge Mount Tub Fillers/Tubos de Salida de Agua para Montar en Bordos de Bañeras	68
Roman Tub Faucets & Rough-In Kits/Llaves para Bañeras Romanas y Equipo para Preparación de Instalación	68 - 76
Roman Tub Hand Held Showers/Regaderas de Mano para Bañeras Romanas	77
Bidet Valves/Válvulas de Bidé	78 - 79
Bath Wastes/Desagüe de la Bañera	80 - 81
Miscellaneous Parts/Piezas Misceláneas	82 - 114
Abbreviations & Suffixes/Abreviaciones y Sufijos	115

# Single Handle Kitchen Faucets Manija de Palanca para Fregaderos

## Models/Modelos 100, 110 & 400 Series

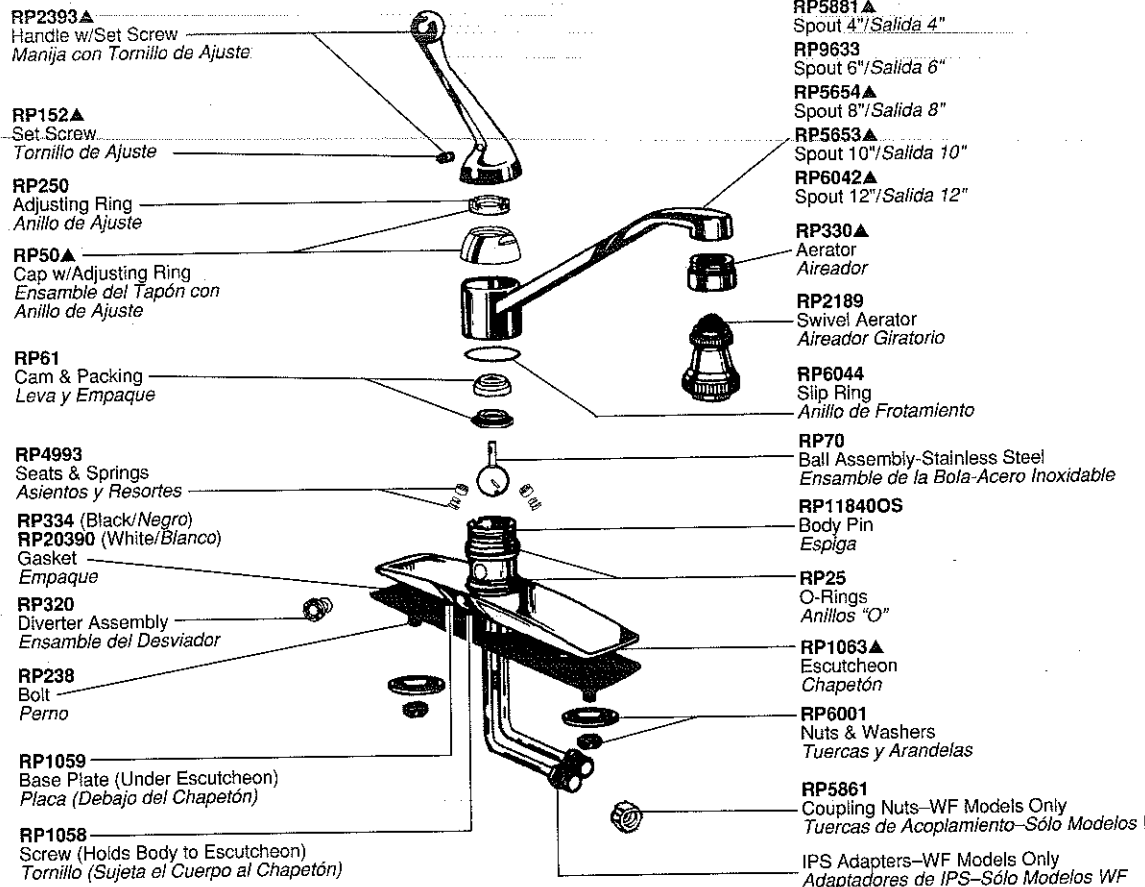

## Models/Modelos 100-D & 400-D Series

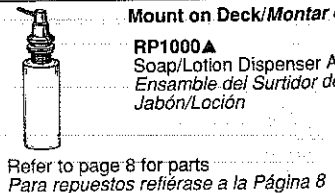
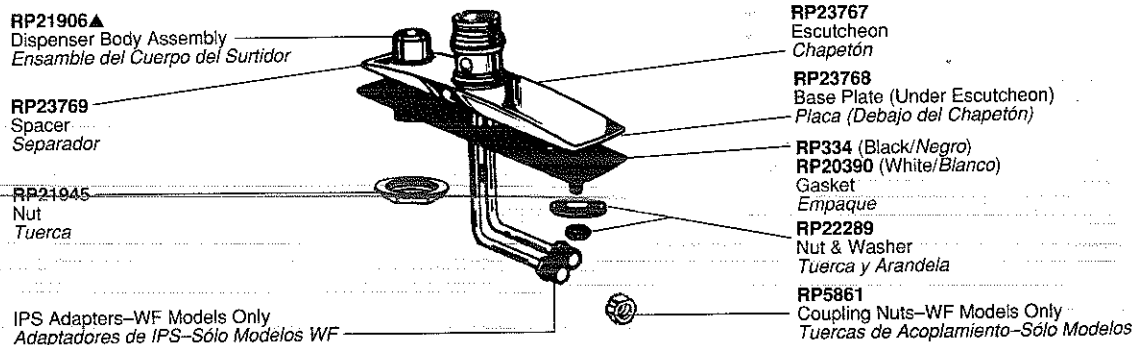

▲ Designate proper finish suffix. Verify available finishes in Miscellaneous Parts Section. **Note:** Chrome models have no finish suffix. AL=Almond, WH=White.

▲ *Designe el sufijo apropiado para el acabado. Verifique acabados disponibles en la sección de Piezas Misceláneas. **Nota:** El acabado de los modelos de cromo no tienen sufijo. AL=Almendra, WH=Blanco.*

## Model/Modelo 300 Series

**RP2393▲**  
Handle w/Set Screw  
*Manija con Tornillo de Ajuste*

**RP152▲**  
Set Screw  
*Tornillo de Ajuste*

**RP250**  
Adjusting Ring  
*Anillo de Ajuste*

**RP50▲**  
Cap w/Adjusting Ring  
*Ensamble del Tapón con Anillo de Ajuste*

**RP61**  
Cam & Packing  
*Leva y Empaque*

**RP4993**  
Seats & Springs  
*Asientos y Resortes*

**RP334 (Black/Negro)**  
**RP20390 (White/Blanco)**  
Gasket  
*Empaque*

**RP320**  
Diverter Assembly  
*Ensamble del Desviador*

**RP238**  
Bolt/Perno

**RP22289**  
Nut & Washer  
*Tuerca y Arandela*

**RP1060**  
Base Plate (Under Escutcheon)  
*Placa (Debajo del Chapetón)*

**RP1058**  
Screw (Holds Body to Escutcheon)  
*Tornillo (Sujeta el Cuerpo al Chapetón)*

**RP5881▲**  
Spout 4"/Salida 4"

**RP9633**  
Spout 6"/Salida 6"

**RP5654▲**  
Spout 8"/Salida 8"

**RP5653▲**  
Spout 10"/Salida 10"

**RP6042▲**  
Spout 12"/Salida 12"

**RP330▲**  
Aerator  
*Aireador*

**RP6044**  
Slip Ring  
*Anillo de Frotamiento*

**RP70**  
Ball Assembly—Stainless Steel  
*Ensamble de la Bola—Acero Inoxidable*

**RP118400S**  
Body Pin/Espiga

**RP25**  
O-Rings/Anillos "O"

**RP1064▲**  
Escutcheon/Chapetón

**RP286▲**  
Spray Support/Soporte del Rociador

**RP288**  
Grommet (Black)  
*Anillo (Negro)*

**RP287**  
Shank/Espiga

**RP6315**  
Nut & Washer  
*Tuerca y Arandela*

**RP5861**  
Coupling Nuts—WF Models Only  
*Tuercas de Acoplamiento—Sólo Modelos WF*

IPS Adapters—WF Models Only  
*Adaptadores de IPS—Sólo Modelos WF*

## Model/Modelo 300-D Series

**RP21906▲**  
Dispenser Body Assembly  
*Ensamble del Cuerpo Surtidor*

**RP23769**  
Spacer/Separador

**RP21945**  
Nut/Tuerca

IPS Adapters—WF Models Only  
*Adaptadores de IPS—Sólo Modelos WF*

**RP23771**  
Escutcheon  
*Chapetón*

**RP23770**  
Base Plate (Under Escutcheon)  
*Placa (Debajo del Chapetón)*

**RP6315**  
Nut & Washer  
*Tuerca y Arandela*

**RP5861**  
Coupling Nuts—WF Models Only  
*Tuercas de Acoplamiento—Sólo Modelos WF*

**RP21905▲**  
Head Assembly  
*Ensamble de la Cabeza*

**RP21908**  
Pump Assembly  
*Ensamble de la Bomba*

**RP21904**  
Bottle  
*Botella*

**RP3614**  
Repair Kit  
*Herramientas para Reparaciones*

**RP1974**  
Wrench—Handle/Adjusting Ring  
*Llave—Manija/Anillo de Ajuste*

# Single Handle Kitchen Faucets

## Manija de Palanca para Fregaderos

Models/Modelos 101 & 175 Series

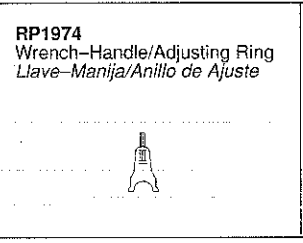
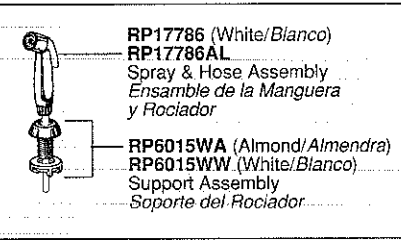
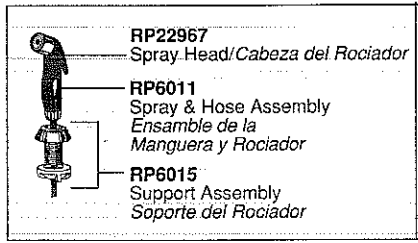
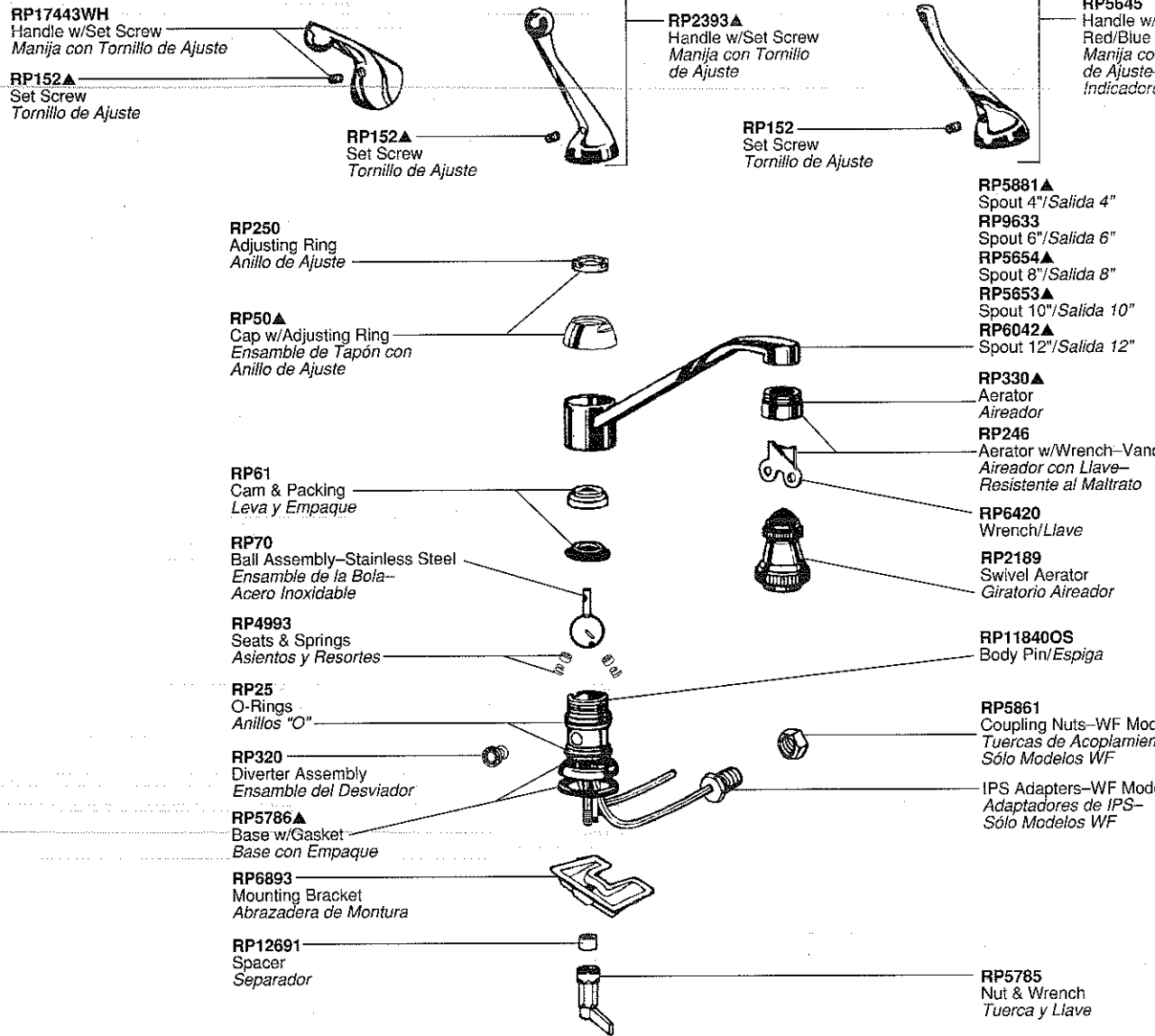

▲ Designate proper finish suffix. Verify available finishes in Miscellaneous Parts Section. **Note:** Chrome models have no finish suffix. AL=Almond, WH=White.

▲ *Designe el sufijo apropiado para el acabado. Verifique acabados disponibles en la sección de Piezas Misceláneas. Nota:* El acabado de los modelos de cromo no tienen sufijo. AL=Almendra, WH=Blanco.

## Models/Modelos 120 & 420 Series

**RP2393**  
Handle w/Set Screw  
*Manija con Tornillo de Ajuste*

**RP152**  
Set Screw  
*Tornillo de Ajuste*

**RP250**  
Adjusting Ring  
*Anillo de Ajuste*

**RP50**  
Cap w/Adjusting Ring  
*Ensamble de Tapón con Anillo de Ajuste*

**RP7462**  
Snap Ring  
*Aro de Resorte*

**RP61**  
Cam & Packing  
*Leva y Empaque*

**RP4993**  
Seats & Springs  
*Asientos y Resortes*

**RP320**  
Diverter Assembly  
*Ensamble del Desviador*

**RP6183**  
Locknuts  
*Contratuercas*

**RP5861**  
Coupling Nuts  
*Tuercas de Acoplamiento*

**RP5881**  
Spout 4"/Salida 4"

**RP9633**  
Spout 6"/Salida 6"

**RP5654**  
Spout 8"/Salida 8"

**RP5653**  
Spout 10"/Salida 10"

**RP6042**  
Spout 12"/Salida 12"

**RP330**  
Aerator  
*Aireador*

**RP2189**  
Swivel Aerator  
*Aireador Giratorio*



**RP70**  
Ball Assembly—Stainless Steel  
*Ensamble de la Bola—Acero Inoxidable*

**RP11840OS**  
Body Pin/Espiga

**RP25**  
O-Rings  
*Anillos "O"*

**RP7461**  
Escutcheon  
*Chapetón*

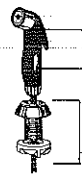
**RP6075**  
Gasket (Black)  
*Empaque (Negro)*

 <p><b>RP22967</b> Spray Head/Cabeza del Rociador</p> <p><b>RP6011</b> Spray &amp; Hose Assembly <i>Ensamble de la Manguera y Rociador</i></p> <p><b>RP6015</b> Support Assembly <i>Soporte del Rociador</i></p>	<p><b>RP1974</b> Wrench—Handle/Adjusting Ring <i>Llave—Manija/Anillo de Ajuste</i></p> 	<p><b>RP3614</b> Repair Kit <i>Herramientas para Reparaciones</i></p> 
---	---	---

# Single Handle Kitchen Faucets Manija de Palanca para Fregaderos

Models/Modelos 150, 350 & 450 Series

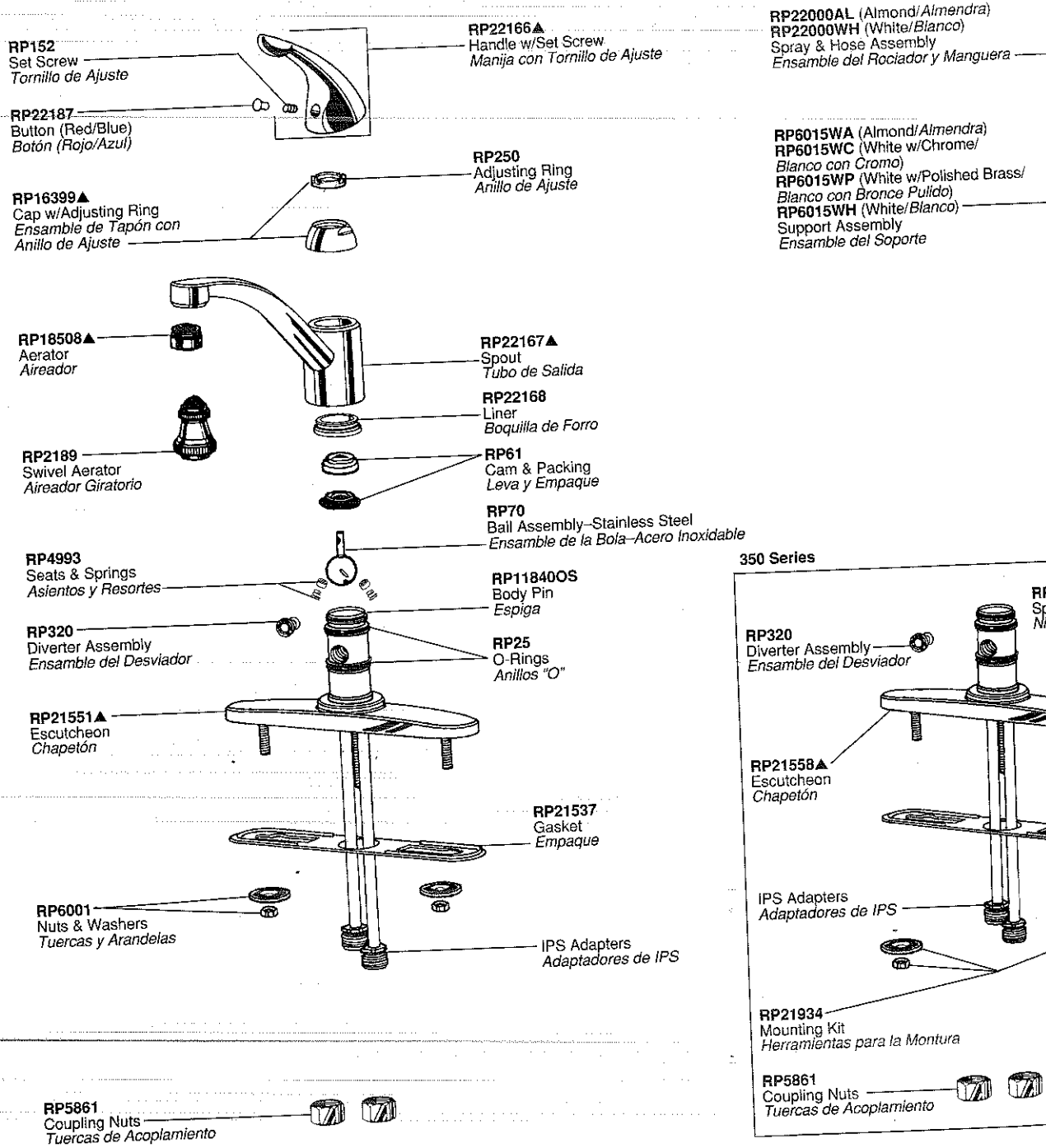

▲ Designate proper finish suffix. Verify available finishes in Miscellaneous Parts Section. **Note:** Chrome models have no finish suffix. AL=Almond, PB=Polished Brass, WH=White.

▲ *Designe el sufijo apropiado para el acabado. Verifique acabados disponibles en la sección de Piezas Misceláneas. Nota: El acabado de los modelos de cromo no tienen sufijo. AL=Almendra, PB=Bronce Pulido, WH=Blanco.*

## Models/Modelos 151 & 451 Series

**RP152**  
Set Screw  
Tornillo de Ajuste

**RP22187**  
Button (Red/Blue)  
Botón (Rojo/Azul)

**RP16399▲**  
Cap w/Adjusting Ring  
Ensamble del Tapón con Anillo de Ajuste

**RP18508▲**  
Aerator  
Aireador

**RP2189**  
Swivel Aerator  
Aireador Giratorio

**RP4993**  
Seats & Springs  
Asientos y Resortes

Mounting Shank  
Espiga de Montura

Notch  
Ranura/Muesca

**RP21538▲**  
Base/Base

**RP23075**  
O-Ring  
Anillo "O"

**RP6893**  
Mounting Bracket  
Abrazadera de Montura

**RP5785**  
Nut & Wrench  
Tuerca y Llave

**RP5861**  
Coupling Nuts  
Tuercas de Acoplamiento

**RP22166▲**  
Handle w/Set Screw  
Manija con Tornillo de Ajuste

**RP250**  
Adjusting Ring  
Anillo de Ajuste

**RP22167▲**  
Spout  
Tubo de Salida

**RP22168**  
Liner  
Boquilla de Forro

**RP61**  
Cam & Packing  
Leva y Empaque

**RP70**  
Ball Assembly—Stainless Steel  
Ensamble de la Bola—Acero Inoxidable

**RP11840QS**  
Body Pin  
Espiga

**RP25**  
O-Rings  
Anillos "O"

IPS Adapters  
Adaptadores de IPS

**RP22000AL** (Almond/Almendra)  
**RP22000WH** (White/Blanco)  
Spray & Hose Assembly  
Ensamble del Rociador y Manguera

**RP6015WA** (Almond/Almendra)  
**RP6015WC** (White w/Chrome/  
Blanco con Cromo)  
**RP6015WP** (White w/Polished Brass/  
Blanco con Bronce Pulido)  
**RP6015WH** (White/Blanco)  
Support Assembly  
Ensamble del Soporte

### 451 Series

**RP320**  
Diverter Assembly  
Ensamble del Desviador

Mounting Shank  
Espiga de Montura

IPS Adapters  
Adaptadores de IPS

Notch  
Ranura/Muesca  
**RP21538▲**  
Base/Base

**RP23075**  
O-Ring  
Anillo "O"

**RP11721**  
Mounting Bracket  
Abrazadera de Montura

**RP11722**  
Nut & Wrench  
Tuerca y Llave

**RP5861**  
Coupling Nuts  
Tuercas de Acoplamiento



# Single Handle Kitchen Faucets

## Manija de Palanca para Fregaderos

### Models/Modelos 172, 173 & 174 Series

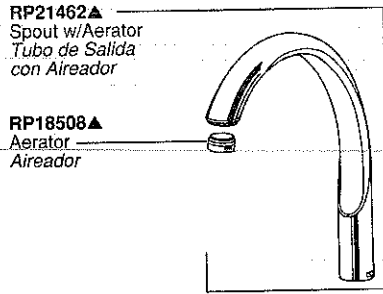

**RP21462▲**  
Spout w/Aerator  
Tubo de Salida  
con Aireador

**RP18508▲**  
Aerator  
Aireador



**RP2189**  
Swivel Aerator  
Aireador Giratorio

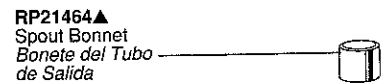

**RP21464▲**  
Spout Bonnet  
Bonete del Tubo  
de Salida

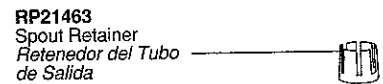

**RP21463**  
Spout Retainer  
Retenedor del Tubo  
de Salida

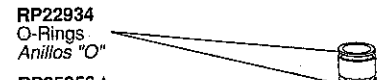

**RP22934**  
O-Rings  
Anillos "O"



**RP25056▲**  
Body & Base  
Cuerpo y Base



**RP6052**  
Gasket  
Empaque

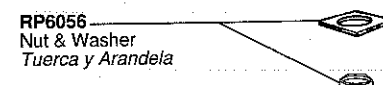

**RP6056**  
Nut & Washer  
Tuerca y Arandela

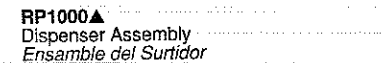

**RP1000▲**  
Dispenser Assembly  
Ensamble del Surtidor

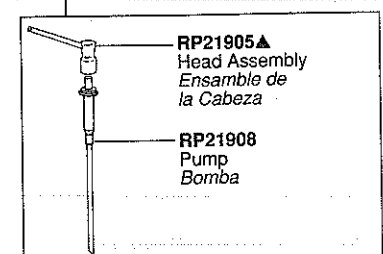

**RP21905▲**  
Head Assembly  
Ensamble de  
la Cabeza

**RP21908**  
Pump  
Bomba

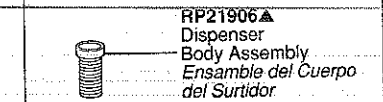

**RP21906▲**  
Dispenser  
Body Assembly  
Ensamble del Cuerpo  
del Surtidor

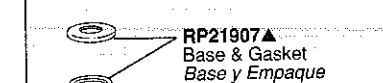

**RP21907▲**  
Base & Gasket  
Base y Empaque



**RP21945**  
Nut  
Tuerca

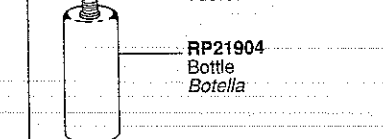

**RP21904**  
Bottle  
Botella

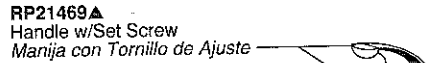

**RP21469▲**  
Handle w/Set Screw  
Manija con Tornillo de Ajuste

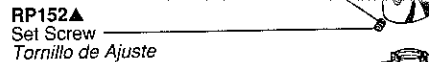

**RP152▲**  
Set Screw  
Tornillo de Ajuste

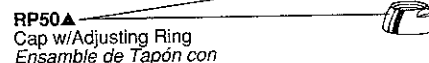

**RP50▲**  
Cap w/Adjusting Ring  
Ensamble de Tapón con  
Anillo de Ajuste

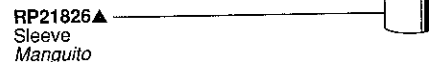

**RP21826▲**  
Sleeve  
Manguito



**RP61**  
Cam & Packing  
Leva y Empaque

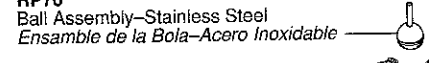

**RP70**  
Ball Assembly—Stainless Steel  
Ensamble de la Bola—Acero Inoxidable



**RP4993**  
Seats & Springs  
Asientos y Resortes



**RP320**  
Diverter Assembly  
Ensamble del Desviador

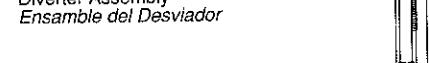

**RP11721**  
Bracket  
Abrazadera

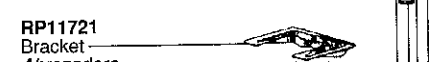

**RP11722**  
Nut & Wrench  
Tuerca y Llave

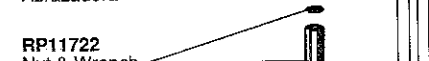

**RP25548▲ †**  
**RP15442▲ ††**  
Base w/Gasket  
Base con Empaque



**RP6052**  
Gasket  
Empaque

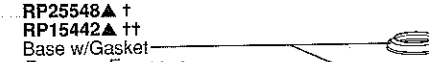

**RP5861**  
Coupling Nuts  
Tuercas de Acoplamiento

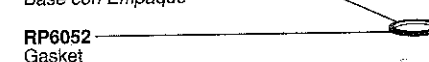

**RP6050**  
Spout Hose  
Manguera del Tubo  
de Salida

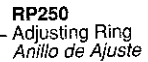

**RP250**  
Adjusting Ring  
Anillo de Ajuste



**RP61**  
Cam & Packing  
Leva y Empaque

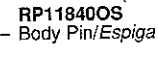

**RP11840OS**  
Body Pin/Espiga

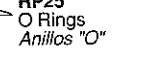

**RP25**  
O Rings  
Anillos "O"

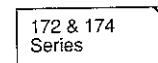

**IPS Adapters**  
Adaptadores de IPS



**172 & 174 Series**  
Spout Hose  
Conexión de  
la Manguera  
del Tubo de  
Salida

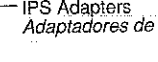

**IPS Adapters**  
Adaptadores de IPS

† Manufactured after May  
Fabricado después de M

†† Manufactured before May  
Fabricado antes de Mayo

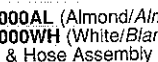

**RP22000AL (Almond/Almendra)**  
**RP22000WH (White/Blanco)**  
Spray & Hose Assembly  
Ensamble del Rociador y Manguera

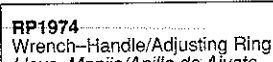

**RP1974**  
Wrench—Handle/Adjusting Ring  
Llave—Manija/Anillo de Ajuste

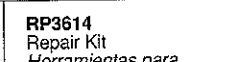

**RP3614**  
Repair Kit  
Herramientas para  
Reparaciones

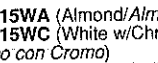

**RP6015WA (Almond/Almendra)**  
**RP6015WC (White w/Chrome/**  
**Blanco con Cromo)**

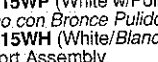

**RP6015WP (White w/Polished Brass/**  
**Blanco con Bronce Pulido)**  
**RP6015WH (White/Blanco)**



Support Assembly  
Ensamble del Soporte

▲ Designate proper finish suffix. Verify available finishes in Miscellaneous Parts Section. **Note:** Chrome models have no finish suffix. AL=Almond, CB=Chrome/Polished Brass, PB=Polished Brass, WH=White.

▲ *Designe el sufijo apropiado para el acabado. Verifique acabados disponibles en la sección de Piezas Misceláneas. Nota: El acabado de los modelos de cromo no tienen sufijo. AL=Almendra, CB=Cromo/Bronce Pulido, PB=Bronce Pulido, WH=Blanco.*

## Models/Modelos 200 & 275 Series

**RP2393**  
Handle w/Set Screw  
*Manija con Tornillo de Ajuste*

**RP152**  
Set Screw  
*Tornillo de Ajuste*

**RP50**  
Cap w/Adjusting Ring  
*Ensamble del Tapón con Anillo de Ajuste*

**RP330**  
Aerator  
*Aireador*

**RP2189**  
Swivel Aerator  
*Aireador Giratorio*

**RP61**  
Cam & Packing  
*Leva y Empaque*

**RP70**  
Ball Assembly—Stainless Steel  
*Ensamble de la Bola—Acero Inoxidable*

**RP4993**  
Seats & Springs  
*Asientos y Resortes*

**RP320**  
Diverter Assembly  
*Ensamble del Desviador*

**RP19363**  
Insert Assembly  
*Ensamble del Accesorio de Inserción*

**RP6034**  
Escutcheon  
*Chapetón*

**RP1058**  
Screw  
*Tornillo*

**RP250**  
Adjusting Ring  
*Anillo de Ajuste*

**RP5881†**  
Spout 4"/Salida 4"

**RP9633†**  
Spout 6"/Salida 6"

**RP5654†**  
Spout 8"/Salida 8"

**RP5879††**  
Spout 8"/Salida 8"

**RP5653†**  
Spout 10"/Salida 10"

**RP6042†**  
Spout 12"/Salida 12"

**RP6044**  
Slip Ring  
*Anillo de Frotamiento*

**RP118400S**  
Body Pin/Espiga

**RP25**  
O-Rings  
*Anillos "O"*

**RP6315**  
Washers & Nuts  
*Arandelas y Tuercas*

**RP6038**  
Connectors, Washers & Nuts  
*Conectores, Arandelas y Tuercas*

**RP19361†**  
**RP6036††**  
Insert Assembly  
*Ensamble del Accesorio*

†Manufactured after April 1, 1993 / *Fabricado Después de 4-1-93*  
††Manufactured before April 1, 1993 / *Fabricado Antes de 4-1-93*



**RP22967**  
Spray Head/Cabeza del Rociador

**RP19362**  
Spray and Hose Assembly  
*Ensamble de la Manguera y Rociador*

**RP1974**  
Wrench—Handle/Adjusting Ring  
*Llave—Manija/Anillo de Ajuste*



**RP3614**  
Repair Kit  
*Herramientas para Reparaciones*



RP19361



# Single Handle Kitchen Faucets

## Manija de Palanca para Fregaderos

Models/Modelos 460\* & 461\* Series

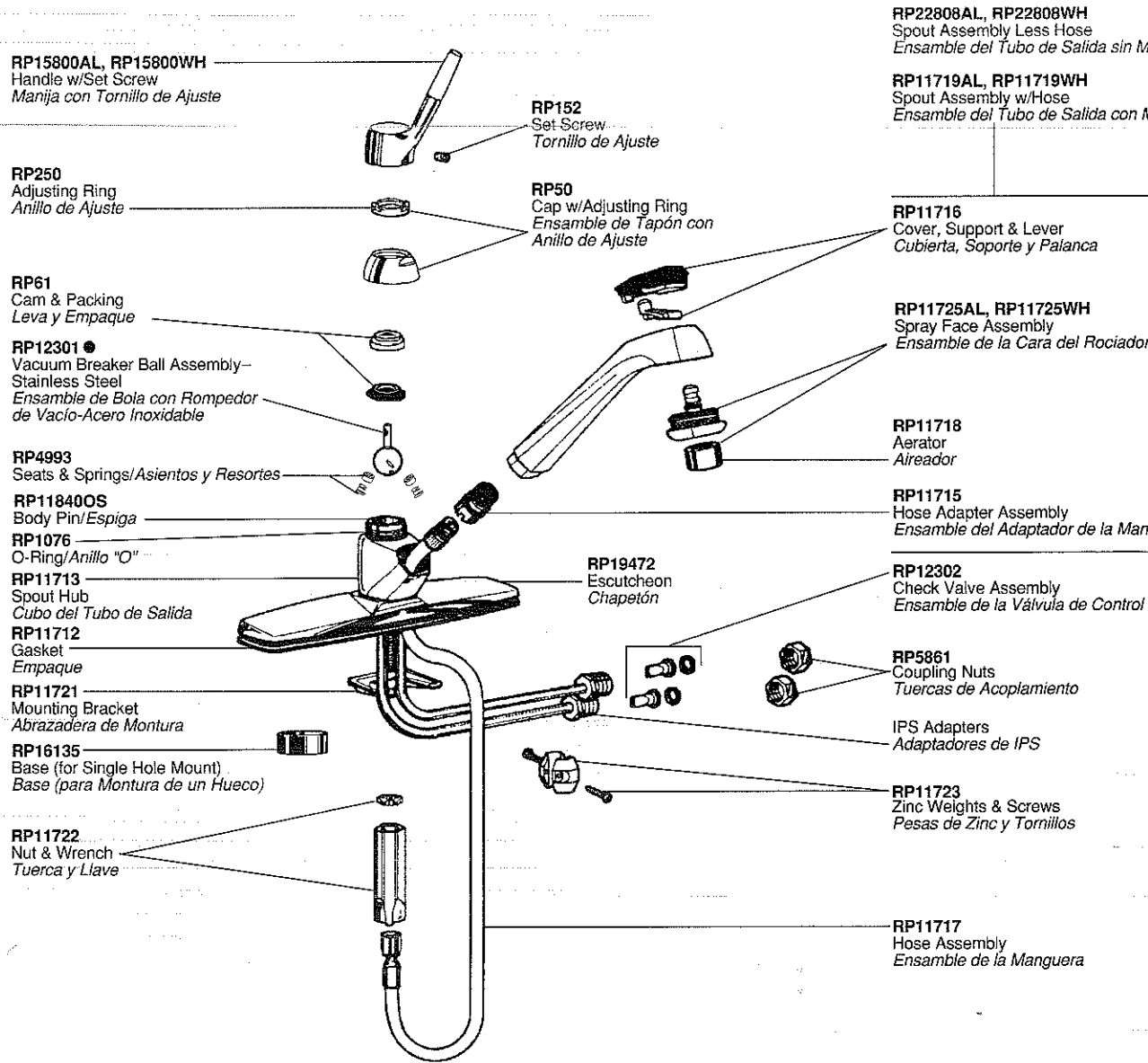

**RP1974**  
Wrench—Handle/Adjusting Ring  
Llave—Manija/Anillo de Ajuste



**RP3614**  
Repair Kit  
Herramientas para Reparaciones



● The vacuum breaker ball assembly is an important part of protecting your drinking water from contamination by back siphonage. Use only the Delta RP12301 ball assembly.

● El ensamble de la bola con rompedor de vacío es una parte importante en la protección de su agua potable la cual puede ser contaminada por causa del retrosedimiento de agua. Use sólo el ensamble Delta RP12301.

\*Discontinued/Descontinuados

▲ Designate proper finish suffix. Verify available finishes in Miscellaneous Parts Section. **Note:** Chrome models have no finish suffix. AL=Almond, CW=Chrome/White, WH=White.

▲ *Designe el sufijo apropiado para el acabado. Verifique acabados disponibles en la sección de Piezas Misceláneas. **Nota:** El acabado de los modelos de cromo no tienen sufijo. AL=Almendra, CW=Cromo/Blanco, WH=Blanco.*

## Models/Modelos 462 & 466 Series

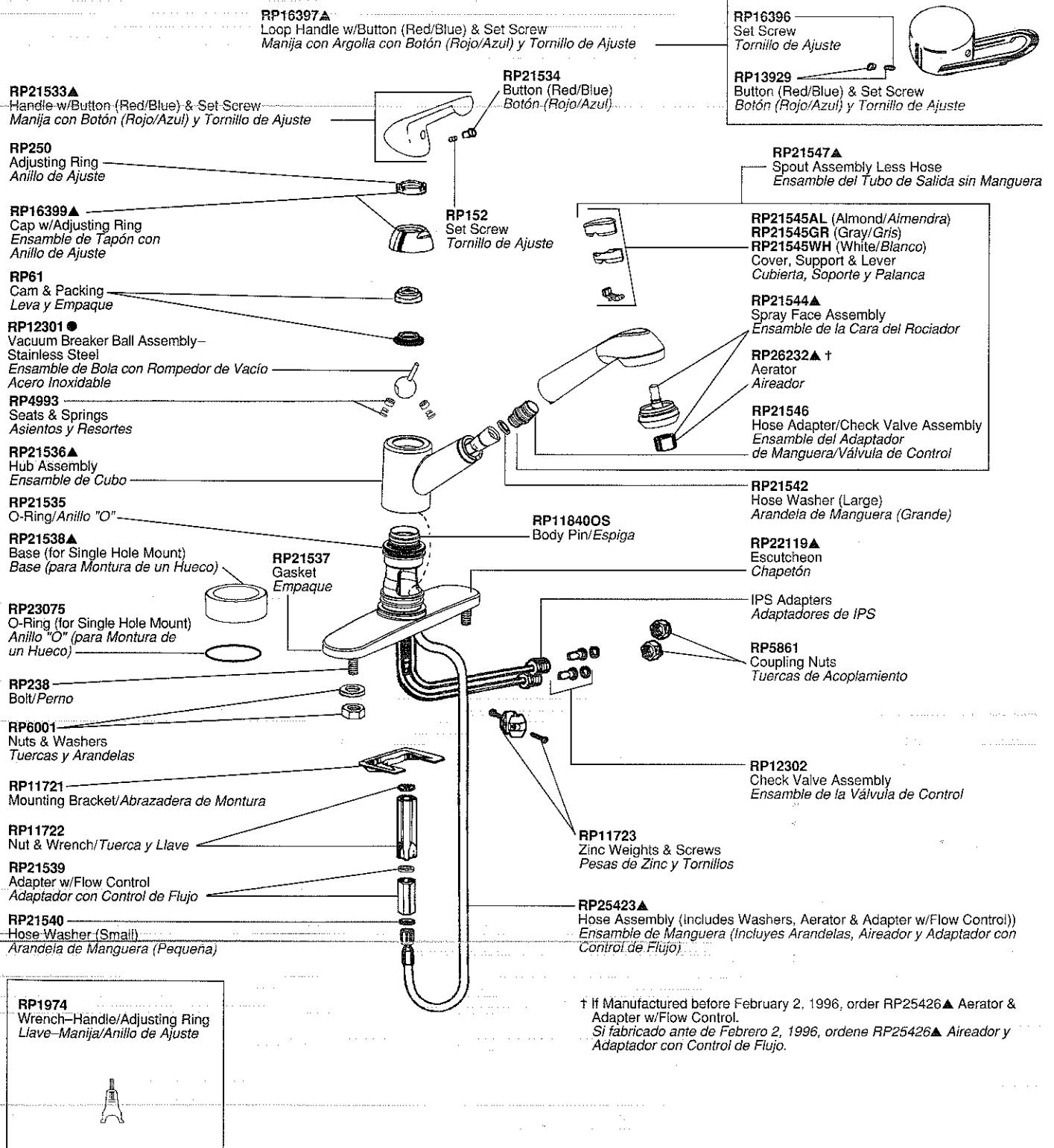

† If Manufactured before February 2, 1996, order RP25426▲ Aerator & Adapter w/Flow Control.  
*Si fabricado ante de Febrero 2, 1996, ordene RP25426▲ Aireador y Adaptador con Control de Flujo.*

● The vacuum breaker ball assembly is an important part of protecting your drinking water from contamination by back siphonage. Use only the Delta RP12301 ball assembly.

● El conjunto de bola con rompevacío es una parte importante en proteger su agua potable de contaminación por causa del retrosedimiento de agua. Use sólo el conjunto de bola Delta RP12301.

# Single Handle Kitchen Faucets

## Manija de Palanca para Fregaderos

Models/Modelos 130\* & 430\* Series

**RP16397▲**  
Handle w/Button (Red/Blue) & Set Screw  
Manija con Botón (Rojo/Azul) y Tornillo de Ajuste

**RP13929**  
Button (Red/Blue) & Set Screw  
Botón (Rojo/Azul) y Tornillo de Ajuste

**RP250**  
Adjusting Ring  
Anillo de Ajuste

**RP330▲**  
Aerator  
Aireador

**RP16399▲**  
Cap w/Adjusting Ring  
Ensamble del Tapón con Anillo

**RP16400▲**  
Spout  
Tubo de Salida

**RP61**  
Cam & Packing  
Leva y Empaque

**RP70**  
Ball Assembly-Stainless Steel  
Ensamble de la Bola-Acero Inoxidable

**RP4993**  
Seats & Springs  
Asientos y Resortes

**RP25**  
O-Rings  
Anillos "O"

**RP118400S**  
Body Pin  
Espiga

**RP16398**  
Washer  
Arandela

**RP13935**  
Retaining Seal  
Sello de Retención

**RP320**  
Diverter Assembly  
Ensamble del Desviador

**RP13936▲**  
Escutcheon  
Chapetón

**RP13937**  
Gasket  
Empaque

**RP16471**  
Support Ring  
Anillo de Soporte

**RP11721**  
Mounting Bracket  
Abrazadera de Montura

IPS Ad  
Adapt

**RP5861**  
Coupling Nuts  
Tuercas de Acoplamiento

**RP11722**  
Nut & Wrench  
Tuerca y Llave

**RP19138**  
Gasket (for Single Hole Mount)  
Empaque (para Montura de un



**RP17781** (White w/Chrome/Blanco con Cromo)  
**RP17786** (White/Blanco)  
**RP17786AL**  
Spray & Hose Assembly  
Ensamble de la Manguera y Rociador

**RP6015WC** (White w/Chrome/Blanco con Cromo)  
**RP6015WA** (Almond/Almendra)  
**RP6015WW** (White/Blanco)  
Support Assembly/Soporte del Rociador

**RP13941**  
Wrench-Handle/Adjusting Ring  
Llave-Manija/Anillo de Ajuste



**RP3614**  
Repair Kit  
Herramientas para Reparaciones



▲ Designate proper finish suffix. Verify available finishes in Miscellaneous Parts Section. **Note:** Chrome models have no finish suffix. AL=Almond, PB=Polished Brass, WH=White.

▲ *Designe el sufijo apropiado para el acabado. Verifique acabados disponibles en la sección de Piezas Misceláneas. Nota: El acabado de los modelos de cromo no tienen sufijo. AL=Almendra, PB=Bronce Pulido, WH=Blanco.*

## Model/Modelo 21460\* Series

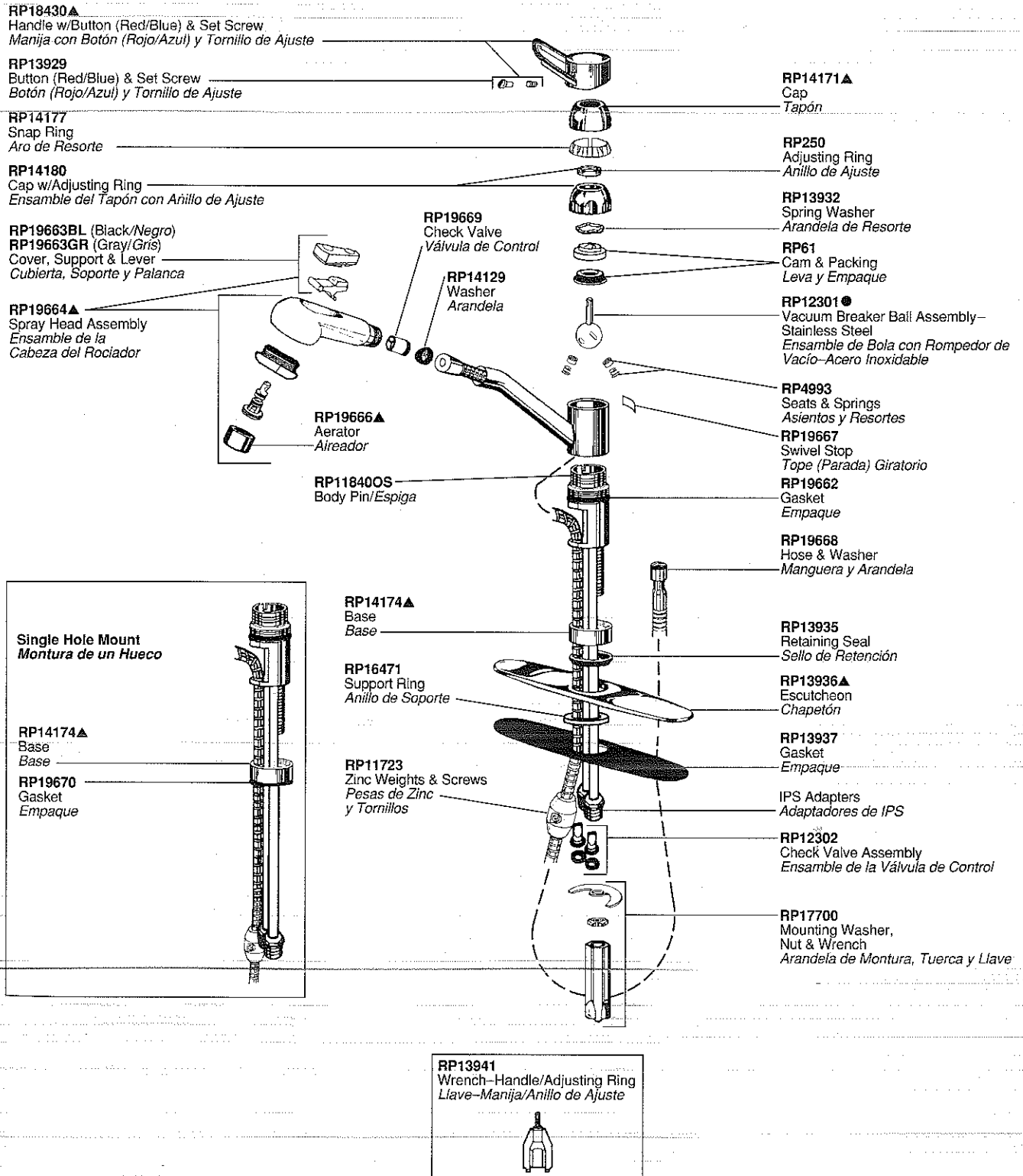

●The vacuum breaker ball assembly is an important part of protecting your drinking water from contamination by back siphonage. Use only the Delta RP12301 ball assembly.

●*El ensamble de la bola con rompedor de vacío es una parte importante en la protección de su agua potable la cual puede ser contaminada por causa del retrosedimiento de agua... Use sólo el ensamble de bola Delta RP12301.*

\*Discontinued/Descontinuados

# Two Handle Kitchen Faucets Manijas de Palanca para Fregaderos

Models/Modelos 2100, 2102, 2400 & 2402 Series

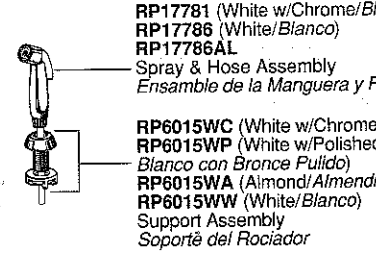
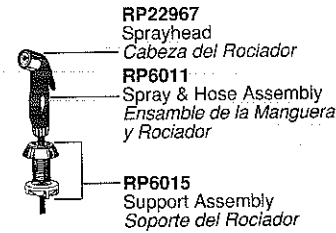
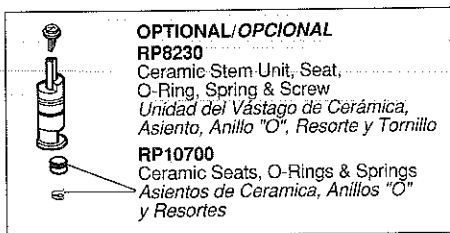
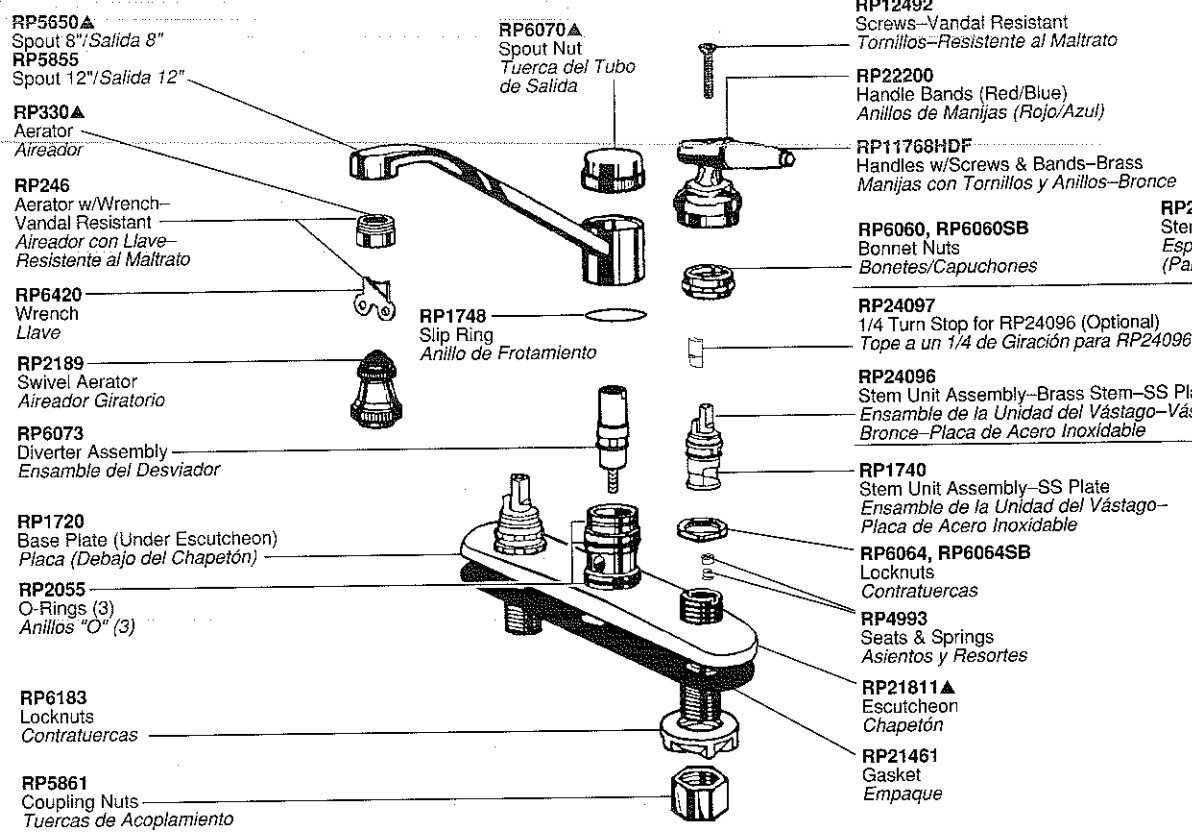

**H41, H41PB**  
Medium Knob Handles w/Buttons & Screws  
Manijas de Perilla Mediana con Botones y Tornillos

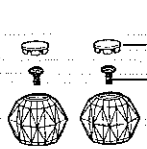

**RP18373, RP18373PB** Button Set (Red/Blue Indicators) Botones (Indicadores: Rojo/Azul)

**RP5885** Screws Tornillos

**H27, H27PB**  
Small Porcelain Cross Handles w/Screws  
Manijas de Cruz, Pequeñas, de Porcelana con Tornillos

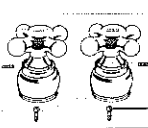

**RP25620** Set Screws Tornillos de Ajuste

**RP20185** Retention Screws Tornillos de Retención

**H46, H46AC, H46AP, H46CB, H46PB, H46PBH**  
Medium Metal Cross Handles w/Screws  
Manijas de Cruz de Metal Mediana con Tornillos

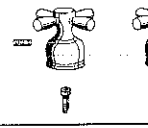

**RP25620** Set Screws Tornillos

**RP20185** Retention Screws Tornillos

**H48**  
Metal Knob Handles w/Buttons & Screws  
Manijas de Perilla de Metal con Botones y Tornillos

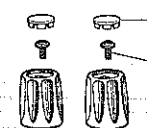

**RP19659** Button Set (Red/Blue Indicators) Botones (Indicadores: Rojo/Azul)

**RP5885** Screws Tornillos

**H21, H21PB**  
Small Knob Handles w/Buttons & Screws  
Manijas de Perilla Pequeña con Botones y Tornillos

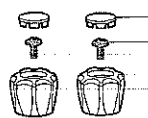

**RP18373, RP18373PB** Button Set (Red/Blue Indicators) Botones (Indicadores: Rojo/Azul)

**RP5885** Screws Tornillos

**H28**  
Blade Handles w/Buttons & Screws  
Manijas de Palanca con Botones y Tornillos

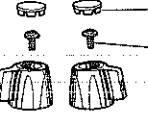

**RP2412** Button Set Botones

**RP5885** Screws Tornillos

▲ Designate proper finish suffix. Verify available finishes in Miscellaneous Parts Section. **Note:** Chrome models have no finish suffix. AC=Almond/Chrome, AL=Almond, AP=Almond/Polished Brass, CB=Chrome/Polished Brass, PB=Polished Brass, WC=White/Chrome, WH=White, WP=White/Polished Brass.

▲ Designe el sufijo apropiado para el acabado. Verifique acabados disponibles en la sección de Piezas Misceláneas. **Nota:** El acabado de los modelos de cromo no tienen sufijo. AC=Aimendra/Cromo, AL=Aimendra, AP=Aimendra/Bronce Pulido, CB=Cromo/Bronce Pulido, PB=Bronce Pulido, WC=Blanco/Cromo, WH=Blanco, WP=Blanco/Bronce Pulido.

## Models/Modelos 2167 & 2467 Series

**RP21962▲**  
Spout Assembly  
Ensamble del Tubo de Salida

**RP18454, RP18454PB**  
Aerator  
Aireador

**RP1129**  
Thin O-Ring  
Anillo "O" Delgado

**RP21963**  
Bushing  
Casquillo (Buje)

**RP20049**  
Thick O-Ring  
Anillo "O" Grueso

**RP15535▲**  
Spout Bonnet  
Bonete del Tubo de Salida

**RP6073**  
Diverter-Assembly  
Ensamble del Desviador

**RP15536▲**  
Escutcheon  
Chapetón

**RP21461 (Black/Negro)**  
**RP20944 (Almond/Aimendra)**  
**RP20782 (White/Blanco)**  
Gasket  
Empaque

**RP6183**  
Locknuts  
Contratuercas

**RP5861**  
Coupling Nuts  
Tuercas para Acoplamiento

**RP6060, RP6060SB**  
Bonnet Nuts  
Bonetes/Capuchones

**RP1740**  
Stem Unit Assembly-SS Plate  
Ensamble de la Unidad del Vástago-  
Placa de Acero Inoxidable

**RP6064, RP6064SB**  
Locknuts  
Contratuercas

**RP4993**  
Seats & Springs  
Asientos y Resortes

**RP1720**  
Base Plate (Under Escutcheon)  
Placa (Inferior de Chapetón)

**RP17781 (White w/Chrome/Blanco con Cromo)**

**RP17786 (White/Blanco)**

**RP17786AL**

Spray & Hose Assembly

Ensamble de la Manguera y Rociador

**RP6015AC (Almond w/Chrome/Aimendra con Cromo)**

**RP6015AP (Almond w/Polished Brass/Aimendra con Bronce Pulido)**

**RP6015WC (White w/Chrome/Blanco con Cromo)**

**RP6015WP (White w/Polished Brass/Blanco con Bronce Pulido)**

Spray Support

Soporte para el Rociador

**H22, H22AB, H22AL, H22PB, H22WH**  
Small Lever Handles w/Screws  
Manijas Pequeña de Palanca con Tornillos

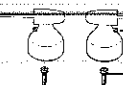

**RP25620**

Set Screws/Tornillos de Ajuste

**RP20185**

Retention Screws

Tornillos de Retención

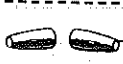

**A22, A22AB, A22AL, A22CL, A22OK, A22PB, A22PR, A22RS, A22WH, A22WW**  
Handle Accents/Acentos para Manijas

**H25, H25AC, H25AP, H25CA, H25CB, H25CW, H25CK, H25PA, H25PB, H25PK, H25PW, H25WC, H25WP**  
Small Lever Handles w/Screws  
Manijas Pequeñas de Palanca con Tornillos



**RP25620**

Set Screws/Tornillos de Ajuste

**RP20185**

Retention Screws

Tornillos de Retención

**H24, H24AL, H24PB, H24WH**  
Small Lever Handles w/Screws  
Manijas Pequeñas de Palanca con Tornillos

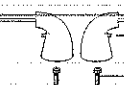

**RP25620**

Set Screws/Tornillos de Ajuste

**RP20185**

Retention Screws

Tornillos de Retención

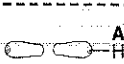

**A24, A24AL, A24CL, A24PB, A24WH**  
Handle Accents/Acentos para Manijas

**RP12490**  
Screws-Vandal Resistant  
(Red/Blue)  
Tornillos-Resistente al  
Maltrato (Rojo/Azul)



**RP12491**  
Wrist Blade Handles  
w/Screws (Red/Blue)  
Manijas Tipo Aleta  
con Tornillos  
(Rojo/Azul)



**H23, H23AB, H23AL, H23PB, H23WH**  
Small Ring Handles w/Caps & Screws  
Manijas de Anillo Pequeño con Casquetes y Tornillos



**RP18342, RP18342AB, RP18342AL, RP18342PB, RP18342WH**  
Handle Cap  
Casquete de la Manija

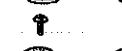

**RP5885**  
Screws/Tornillos



**RP18340, RP18340AB, RP18340AL, RP18340PB, RP18340WH**  
Handle Base  
Base de la Manija



**A23, A23AB, A23AL, A23OK, A23PB, A23ST, A23WH**  
Handle Accents  
Acentos para Manijas

See Page 19 for Handle Suffix Chart/Vea la Tabla en Página 19 para Más Detalles Sobre Sufijos de Manijas



# Two Handle Kitchen Faucets

## Manijas de Palanca para Fregaderos

Models/Modelos 2147 & 2447 Series

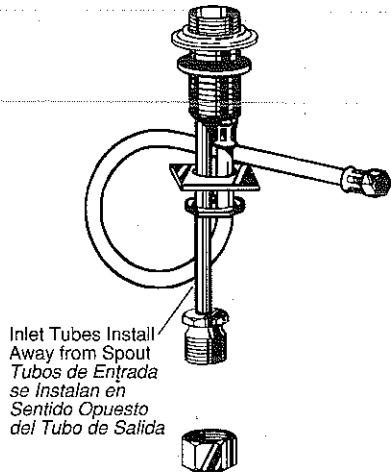

Inlet Tubes Install Away from Spout  
Tubos de Entrada se Instalan en Sentido Opuesto del Tubo de Salida

RP21962, RP21962PB  
Spout Assembly  
Ensamble del Tubo de Salida

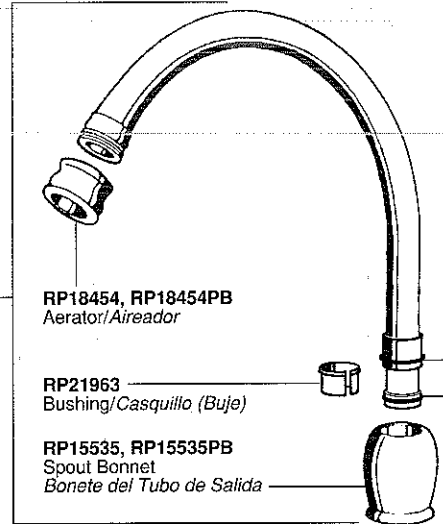

RP18454, RP18454PB  
Aerator/Aireador

RP21963  
Bushing/Casquillo (Buje)

RP15535, RP15535PB  
Spout Bonnet  
Bonete del Tubo de Salida

RP1129  
Thin O-Ring  
Anillo "O"

RP2004  
Thick O-Ring  
Anillo "O"

RP23101, RP23101PB  
Body Assembly (w/Spray)  
Ensamble del Cuerpo (con Rociador)

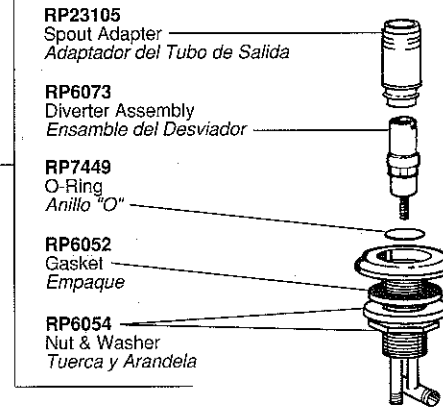

RP23105  
Spout Adapter  
Adaptador del Tubo de Salida

RP6073  
Diverter Assembly  
Ensamble del Desviador

RP7449  
O-Ring  
Anillo "O"

RP6052  
Gasket  
Empaque

RP6054  
Nut & Washer  
Tuerca y Arandela

RP22132  
Helpful Hand Installation Aid  
Utilisilio para Asistencia en Instalaciones a Mano

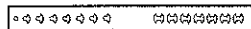

RP11053  
RP11017 (Bulk Kit/Equipo de Cantidades Grandes)  
Thick Tile Mounting Kit  
Equipo/Herramientas para Monturas en Losa (Mosaico) Gruesa

H41, H41PB  
Medium Knob Handles w/Buttons & Screws  
Manijas de Perilla Mediana con Botones y Tornillos

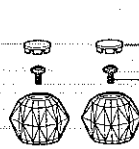

RP18373, RP18373PB  
Button Set (Red/Blue Indicators)  
Botones (Indicadores: Rojo/Azul)  
RP5885  
Screws  
Tornillos

H27, H27PB  
Small Porcelain Cross Handles w/Screws  
Manijas de Cruz Pequeña de Porcelana con Tornillos

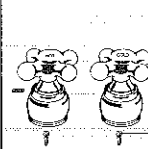

RP25620  
Set Screws  
Tornillos de Ajuste  
RP20185  
Retention Screws  
Tornillos de Retención

H46, H46AC, H46AP, H46CB, H46PB, H46PC  
Medium Metal Cross Handles w/Screws  
Manijas de Cruz de Metal Mediana con Tornillos

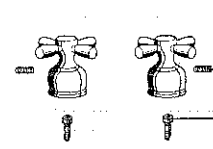

RP25620  
Set Screws  
Tornillos  
RP20185  
Retention  
Tornillos

H48  
Metal Knob Handles w/Buttons & Screws  
Manijas de Perilla de Metal con Botones y Tornillos

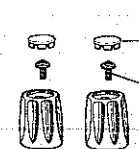

RP19659  
Button Set (Red/Blue Indicators)  
Botones (Indicadores: Rojo/Azul)  
RP5885  
Screws  
Tornillos

H21, H21PB  
Small Knob Handles w/Buttons & Screws  
Manijas de Perilla Pequeña con Botones y Tornillos

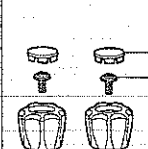

RP18373, RP18373PB  
Button Set (Red/Blue Indicators)  
Botones (Indicadores: Rojo/Azul)  
RP5885  
Screws  
Tornillos

H28  
Blade Handles w/Buttons & Screws  
Manijas de Palanca con Botones y Tornillos

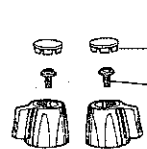

RP2412  
Button Set  
Botones  
RP5885  
Screws  
Tornillos

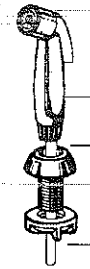

**RP17786**  
Spray & Hose Assembly  
Ensamble de Rociador y Manguera

**RP6015WC** (White w/Chrome/  
Blanco con Cromo)  
**RP6015WP** (White w/Polished Brass/  
Blanco con Bronce Pulido)  
Spray Support  
Soporte para Rociador

**RP23102, RP23102PB**  
Body Assembly (Less Spray)  
Ensamble del Cuerpo (Sin Rociador)

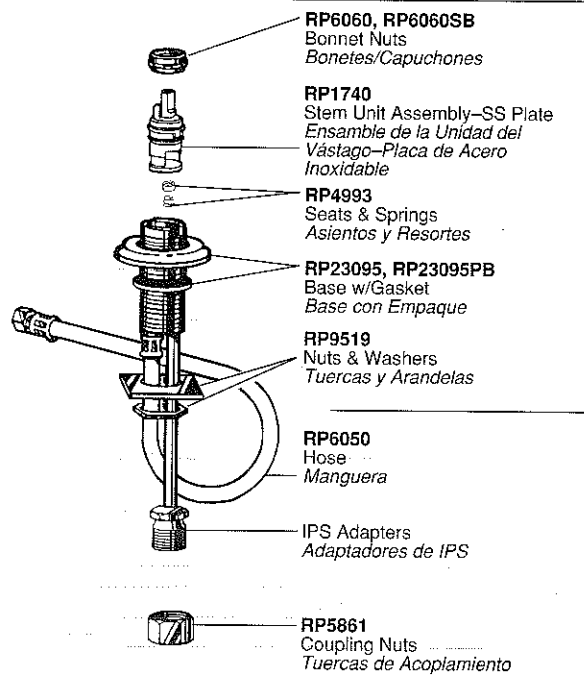
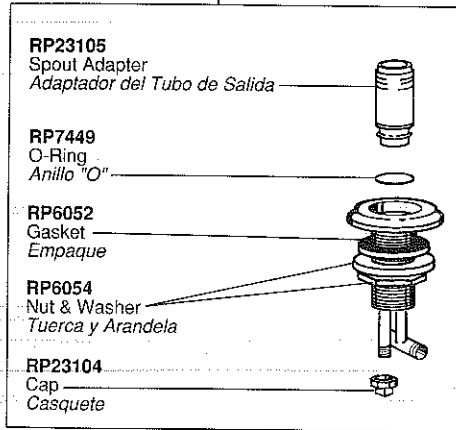

**RP23096, RP23096PB**  
End Valve Assembly—  
WF (IPS Adapter)  
Ensamble de la Válvula Final—  
WF (Adaptador de IPS)

<p><b>H22, H22AB, H22AL, H22PB, H22WH</b> Small Lever Handles w/Screws Manijas Pequeña de Palanca con Tornillos</p>	<p><b>H24, H24AL, H24PB, H24WH</b> Small Lever Handles w/Screws Manijas Pequeñas de Palanca con Tornillos</p>	<p><b>H23, H23AB, H23AL, H23PB, H23WH</b> Small Ring Handles w/Caps &amp; Screws Manijas de Anillo Pequeño con Casquetes y Tornillos</p>
<p><b>RP25620</b> Set Screws/Tornillos de Ajuste</p> <p><b>RP20185</b> Retention Screws Tornillos de Retención</p>	<p><b>RP25620</b> Set Screws/Tornillos de Ajuste</p> <p><b>RP20185</b> Retention Screws Tornillos de Retención</p>	<p><b>RP18342, RP18342AB, RP18342AL, RP18342PB, RP18342WH</b> Handle Cap Casquete de la Manija</p>
<p><b>A22, A22AB, A22AL, A22CL, A22OK, A22PB, A22PR, A22RS, A22WH, A22WW</b> Handle Accents/Acentos para Manijas</p>	<p><b>A24, A24AL, A24CL, A24PB, A24WH</b> Handle Accents/Acentos para Manijas</p>	<p><b>RP5885</b> Screws/Tornillos</p>
<p><b>H25, H25AC, H25AP, H25CA, H25CB, H25CW, H25CK, H25PA, H25PB, H25PK, H25PW, H25WC, H25WP</b> Small Lever Handles w/Screws Manijas Pequeñas de Palanca con Tornillos</p>	<p><b>RP12490</b> Screws—Vandal Resistant (Red/Blue) Tornillos—Resistente al Maltrato (Rojo/Azul)</p> <p><b>RP12491</b> Wrist Blade Handles w/Screws (Red/Blue) Manijas Tipo Aleta con Tornillos (Rojo/Azul)</p>	<p><b>RP18340, RP18340AB, RP18340AL, RP18340PB, RP18340WH</b> Handle Base Base de la Manija</p>
<p><b>RP25620</b> Set Screws/Tornillos de Ajuste</p> <p><b>RP20185</b> Retention Screws Tornillos de Retención</p>	<p><b>A23, A23AB, A23AL, A23OK, A23PB, A23ST, A23WH</b> Handle Accents Acentos para Manijas</p>	<p><b>A23, A23AB, A23AL, A23OK, A23PB, A23ST, A23WH</b> Handle Accents Acentos para Manijas</p>

See Page 19 for Handle Suffix Chart/Vea la tabla en página 19 para más detalles sobre sufijos de manijas

# Two Handle Kitchen Faucets

## Manijas de Palanca para Fregaderos

Models/Modelos 2174, 2176, 2474 & 2476 Series

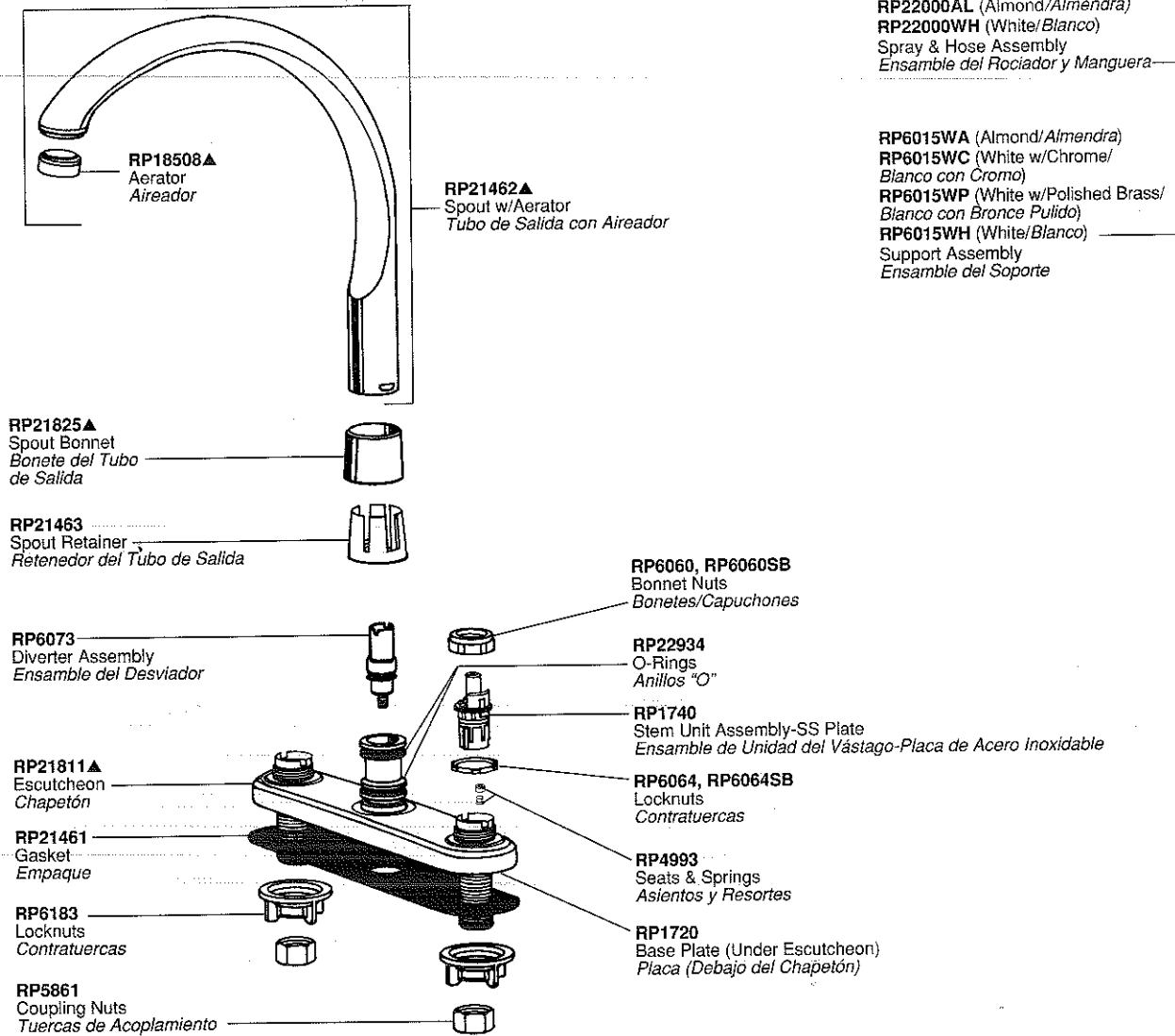

**RP22000AL** (Almond/Almendra)  
**RP22000WH** (White/Blanco)  
Spray & Hose Assembly  
Ensamble del Rociador y Manguera

**RP6015WA** (Almond/Almendra)  
**RP6015WC** (White w/Chrome/  
Blanco con Cromo)  
**RP6015WP** (White w/Polished Brass/  
Blanco con Bronce Pulido)  
**RP6015WH** (White/Blanco)  
Support Assembly  
Ensamble del Soporte

**H41, H41PB**  
Medium Knob Handles w/Buttons & Screws  
Manijas de Perilla Mediana con Botones y Tornillos

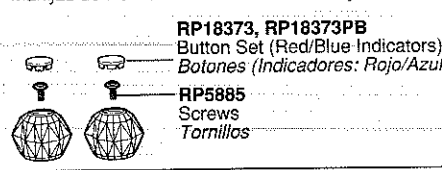

**H27, H27PB**  
Small Porcelain Cross Handles w/Screws  
Manijas de Cruz, Pequeña, de Porcelana con Tornillos

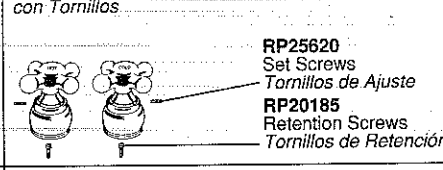

**H46, H46AC, H46AP, H46CB, H46PB**  
Medium Metal Cross Handles w/Screws  
Manijas de Cruz de Metal Mediana con Tornillos

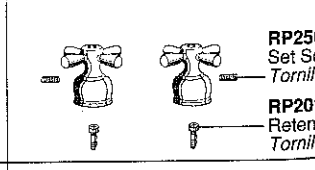

**H48**  
Metal Knob Handles w/Buttons & Screws  
Manijas de Perilla de Metal con Botones y Tornillos

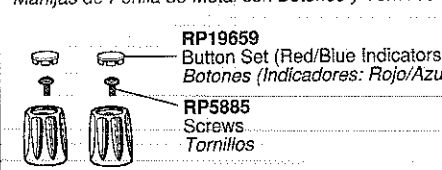

**H21, H21PB**  
Small Knob Handles w/Buttons & Screws  
Manijas de Perilla Pequeña con Botones y Tornillos

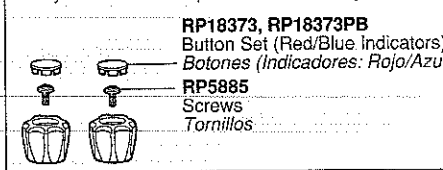

**H28**  
Blade Handles w/Buttons & Screws  
Manijas de Aleta Pequeña con Botones y Tornillos

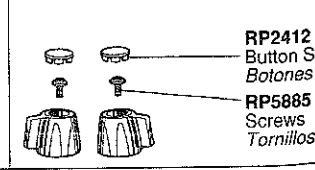

▲ Designate proper finish suffix. Verify available finishes in Miscellaneous Parts Section. **Note:** Chrome models have no finish suffix. AL=Almond, CB=Chrome/Polished Brass, PB=Polished Brass, WH=White.









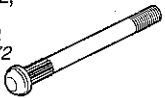
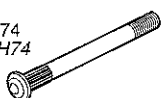

▲ Designe el sufijo apropiado para el acabado. Verifique acabados disponibles en la sección de Piezas Misceláneas. **Nota:** El acabado de los modelos de cromo no tienen sufijo. AL=Almendra, CB=Cromo/Bronce, PB=Bronce Pulido, WH=Blanco.

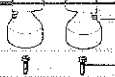
## HANDLE AND HANDLE ACCENT SUFFIX DESIGNATION CHART

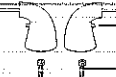
### Tabla de Designación de Sufijos de Manijas y Características

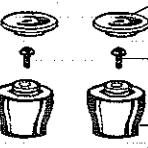
Complete handles and handle bases begin with an "H" and lever and ring accents begin with an "A".  
Las manijas y bases de manerale empiezan con una "H" y los detalles de éstas empiezan con una "A".

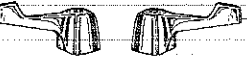
No Suffix	Chrome	Cromo
AB	Antique Brass	Bronce Antiguo
AC	Almond/Chrome	Almendra/Cromo
AL	Almond	Almendra
AP	Almond/Polished Brass	Almendra/Bronce Pulido
CA	Chrome/Almond	Cromo/Almendra
CB	Chrome/Polished Brass	Cromo/Bronce Pulido
CK	Chrome/Oak	Cromo/Roble
CL	Clear	Transparente
CW	Chrome/White	Cromo/Blanco
OK	Oak	Roble
PA	Polished Brass/Almond	Bronce Pulido/Almendra
PB	Polished Brass	Bronce Pulido
PK	Polished Brass/Oak	Bronce Pulido/Roble
PL	Polished Brass/Clear	Bronce Pulido/
PR	Porcelain	Porcelana
PW	Polished Brass/White	Bronce Pulido/Blanco
RS	Rosewood	Palo de Rosa
ST	Soft Touch®/Chrome Lift Rod Finial	Toque Suave/Cromo con Barra-Botón del Desaghe
STAB	Soft Touch®/Antique Brass Lift Rod Finial	Toque Suave/Bronce Antiguo, con Barra-Botón del Desaghe
STAL	Soft Touch®/Almond Lift Rod Finial	Toque Suave/Almendra, con Barra-Botón del Desaghe
STPB	Soft Touch®/Polished Brass Lift Rod Finial	Toque Suave/Bronce Pulido, con Barra-Botón del Desaghe
STWH	Soft Touch®/White Lift Rod Finial	Soft Touch/Blanco, con Barra-Botón del Desaghe
WB	See PW	Ver PW
WC	White/Chrome	Blanco/Cromo
WH	White	Blanco
WP	White/Polished Brass	Blanco/Bronce Pulido
WW	Whitewash (Pickle)	Blanqueado



<p>RP26851, RP26851AB, RP26851AL, RP26851PB, RP26851WH Spindle for H12/H22/H52/H62/H72 Husillo para H12/H22/H52/H62/H72</p> 	<p>RP26852, RP26852AL, RP26852PB, RP26852WH Spindle for H14/H24/H54/H64/H74 Husillo para H14/H24/H54/H64/H74</p> 	<p>RP26853 Allen Wrench for Side Mount Handles-3/32" Llave de Allen para Manijas de Montura de Lado-3/32"</p> 
<p>H22, H22AB, H22AL, H22PB, H22WH Small Lever Handles w/Screws Manijas Pequeña de Palanca con Tornillos</p>  <p>RP25620 Set Screws/Tornillos de Ajuste</p> <p>RP20185 Retention Screws Tornillos de Retención</p>  <p>A22, A22AB, A22AL, A22CL, A22OK, A22PB, A22PR, A22RS, A22WH, A22WW Handle Accents/Acentos para Manijas</p>	<p>H24, H24AL, H24PB, H24WH Small Lever Handles w/Screws Manijas Pequeñas de Palanca con Tornillos</p>  <p>RP25620 Set Screws/Tornillos de Ajuste</p> <p>RP20185 Retention Screws Tornillos de Retención</p>  <p>A24, A24AL, A24CL, A24PB, A24WH Handle Accents/Acentos para Manijas</p>	<p>H23, H23AB, H23AL, H23PB, H23WH Small Ring Handles w/Caps &amp; Screws Manijas de Anillo Pequeño con Casquetes y Tornillos</p>  <p>RP18342, RP18342AB, RP18342AL, RP18342PB, RP18342WH Handle Cap Casquete de la Manija</p> <p>RP5885 Screws/Tornillos</p> <p>RP18340, RP18340AB, RP18340AL, RP18340PB, RP18340WH Handle Base Base de la Manija</p>
<p>H25, H25AC, H25AP, H25CA, H25CB, H25CW, H25CK, H25PA, H25PB, H25PK, H25PW, H25WC, H25WP Small Lever Handles w/Screws Manijas Pequeñas de Palanca con Tornillos</p>  <p>RP25620 Set Screws/Tornillos de Ajuste</p> <p>RP20185 Retention Screws Tornillos de Retención</p>	<p>RP12490 Screws - Vandal Resistant (Red/Blue) Tornillos - Resistente al Maltrato (Rojo/Azul)</p>  <p>RP12491 Wrist Blade Handles w/Screws (Red/Blue) Manijas Tipo Aleta con Tornillos (Rojo/Azul)</p>	<p>A23, A23AB, A23AL, A23OK, A23PB, A23ST, A23WH Handle Accents Acentos para Manijas</p> 

See Above for Handle Suffix Chart/ Vea la tabla en esta página para más detalles sobre sufijos de manijas

# Two Handle Kitchen Faucets Manijas de Palanca para Fregaderos

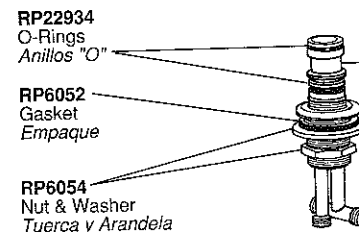
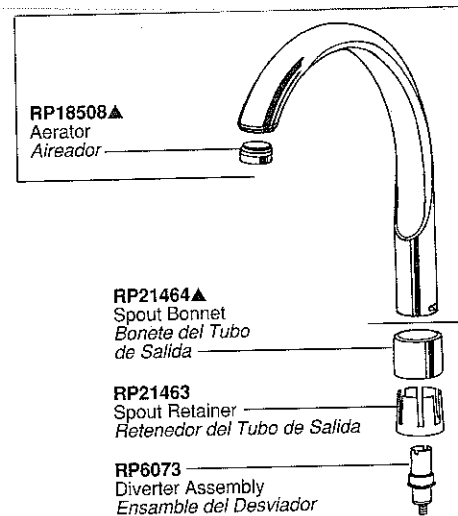
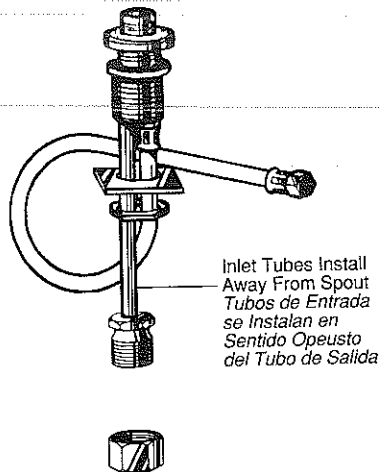
Models/Modelos 2274 & 2276 Series

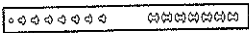
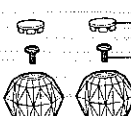
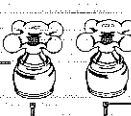

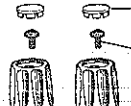
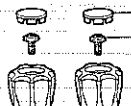
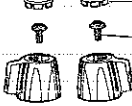
<p><b>RP22132</b> Helpful Hand Installation Aid Utensilio para Asistencia en Instalaciones a Mano</p> 	<p><b>RP11052</b> RP11016 (Bulk Kit/Equipo de Cantidades Grandes) Thick Tile Mounting Kit for 2274 Equipo/Herramientas para Monturas en Losa (Mosaico) Gruesa para 2274</p>	<p><b>RP11053</b> RP11017 (Bulk Kit/Equipo de Cantidades Grandes) Thick Tile Mounting Kit for 2276 Equipo/Herramientas para Monturas en Losa (Mosaico) Gruesa para 2276</p>
<p><b>H41, H41PB</b> Medium Knob Handles w/Buttons &amp; Screws Manijas de Perilla Mediana con Botones y Tornillos</p>  <p><b>RP18373, RP18373PB</b> Button Set (Red/Blue Indicators) Botones (Indicadores: Rojo/Azul)</p> <p><b>RP5885</b> Screws Tornillos</p>	<p><b>H27, H27PB</b> Small Porcelain Cross Handles w/Screws Manijas de Cruz Pequeño de Porcelana con Tornillos</p>  <p><b>RP25620</b> Set Screws Tornillos de Ajuste</p> <p><b>RP20185</b> Retention Screws Tornillos de Retención</p>	<p><b>H46, H46AC, H46AP, H46CB, H46PB</b> Medium Metal Cross Handles w/Screws Manijas de Cruz de Metal Mediana con Tornillos</p>  <p><b>RP20185</b> Retention Screws Tornillos de Retención</p>
<p><b>H48</b> Metal Knob Handles w/Buttons &amp; Screws Manijas de Perilla de Metal con Botones y Tornillos</p>  <p><b>RP19659</b> Button Set (Red/Blue Indicators) Botones (Indicadores: Rojo/Azul)</p> <p><b>RP5885</b> Screws Tornillos</p>	<p><b>H21, H21PB</b> Small Knob Handles w/Buttons &amp; Screws Manijas de Perilla Pequeña con Botones y Tornillos</p>  <p><b>RP18373, RP18373PB</b> Button Set (Red/Blue Indicators) Botones (Indicadores: Rojo/Azul)</p> <p><b>RP5885</b> Screws Tornillos</p>	<p><b>H28</b> Blade Handles w/Buttons &amp; Screws Manijas de Aleta Pequeña con Botones y Tornillos</p>  <p><b>RP241</b> Button Set Botones</p> <p><b>RP5885</b> Screws Tornillos</p>

▲ Designate proper finish suffix. Verify available finishes in Miscellaneous Parts Section. **Note:** Chrome models have no finish suffix. AL=Almond, CB=Chrome/Polished Brass, PB=Polished Brass, WH=White.

▲ *Designe el sufijo apropiado para el acabado. Verifique acabados disponibles en la sección de Piezas Misceláneas. Nota: El acabado de los modelos de cromo no tienen sufijo. AL=Almendra, CB=Cromo/Bronce Pulido, PB=Bronce Pulido, WH=Blanco.*

RP22000AL (Almond/Almendra)  
RP22000WH (White/Blanco)  
Spray & Hose Assembly  
Ensamble del Rociador y Manguera

RP6015WA (Almond/Almendra)  
RP6015WC (White w/Chrome/  
Blanco con Cromo)  
RP6015WP (White w/Polished Brass/  
Blanco con Bronce Pulido)  
RP6015WH (White/Blanco)  
Support Assembly  
Ensamble del Soporte

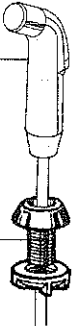

For Less Spray Models  
Para Modelos de Llave sin Rociador

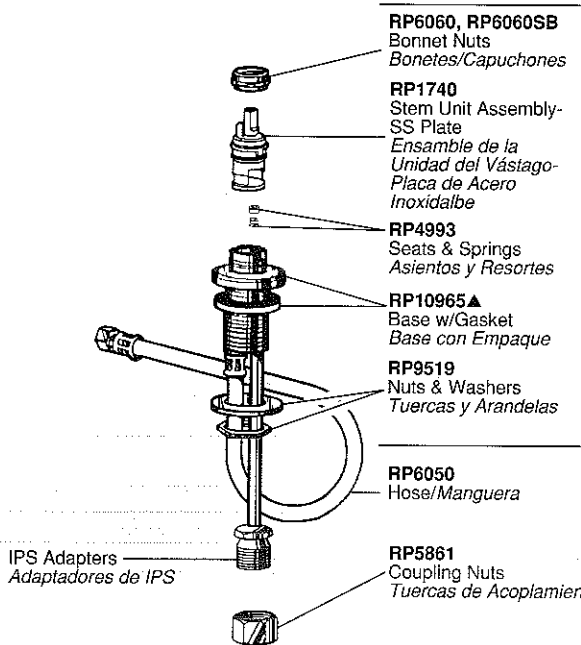
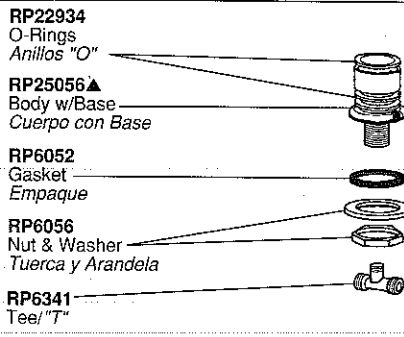

RP4258▲  
End Valve Assembly-  
WF (IPS Adapter)  
Ensamble de Válvula Final-WF  
(Adaptador de IPS)

IPS Adapters  
Adaptadores de IPS

H22, H22AB, H22AL, H22PB, H22WH  
Small Lever Handles w/Screws  
Manijas Pequeñas de Palanca con Tornillos

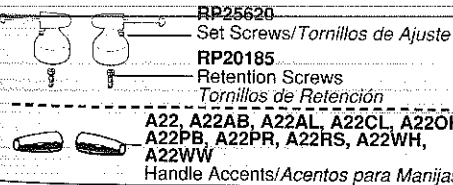

H25, H25AC, H25AP, H25CA, H25CB, H25CW, H25CK,  
H25PA, H25PB, H25PK, H25PW, H25WC, H25WP  
Small Lever Handles w/Screws  
Manijas de Pequeñas de Palanca con Tornillos



H24, H24AL, H24PB, H24WH  
Small Lever Handles w/Screws  
Manijas Pequeñas de Palanca con Tornillos



RP12490  
Screws-Vandal Resistant  
(Red/Blue)  
Tornillos-Resistente al  
Maltrato (Rojo/Azul)

RP12491  
Wrist Blade Handles  
w/Screws (Red/Blue)  
Manijas de Tipo Aleta  
con Tornillos  
(Rojo/Azul)



H23, H23AB, H23AL, H23PB, H23WH  
Small Ring Handles w/Caps & Screws  
Manijas de Anillo Pequeña con Casquetes y Tornillos

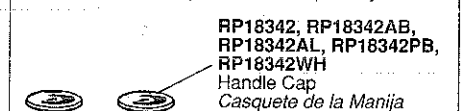

RP5885  
Screws/Tornillos

RP18340, RP18340AB,  
RP18340AL, RP18340PB,  
RP18340WH  
Handle Base  
Base de la Manija

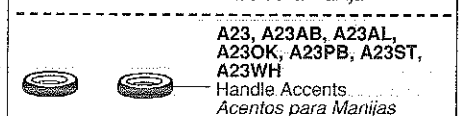

See Page 19 for Handle Suffix Chart/ Vea la tabla en página 19 para más detalles sobre sufijos de manijas

# Two Handle Bar Faucets Manijas de Palanca para Bares

Models/Modelos 2170, 2171 & 2172 Series

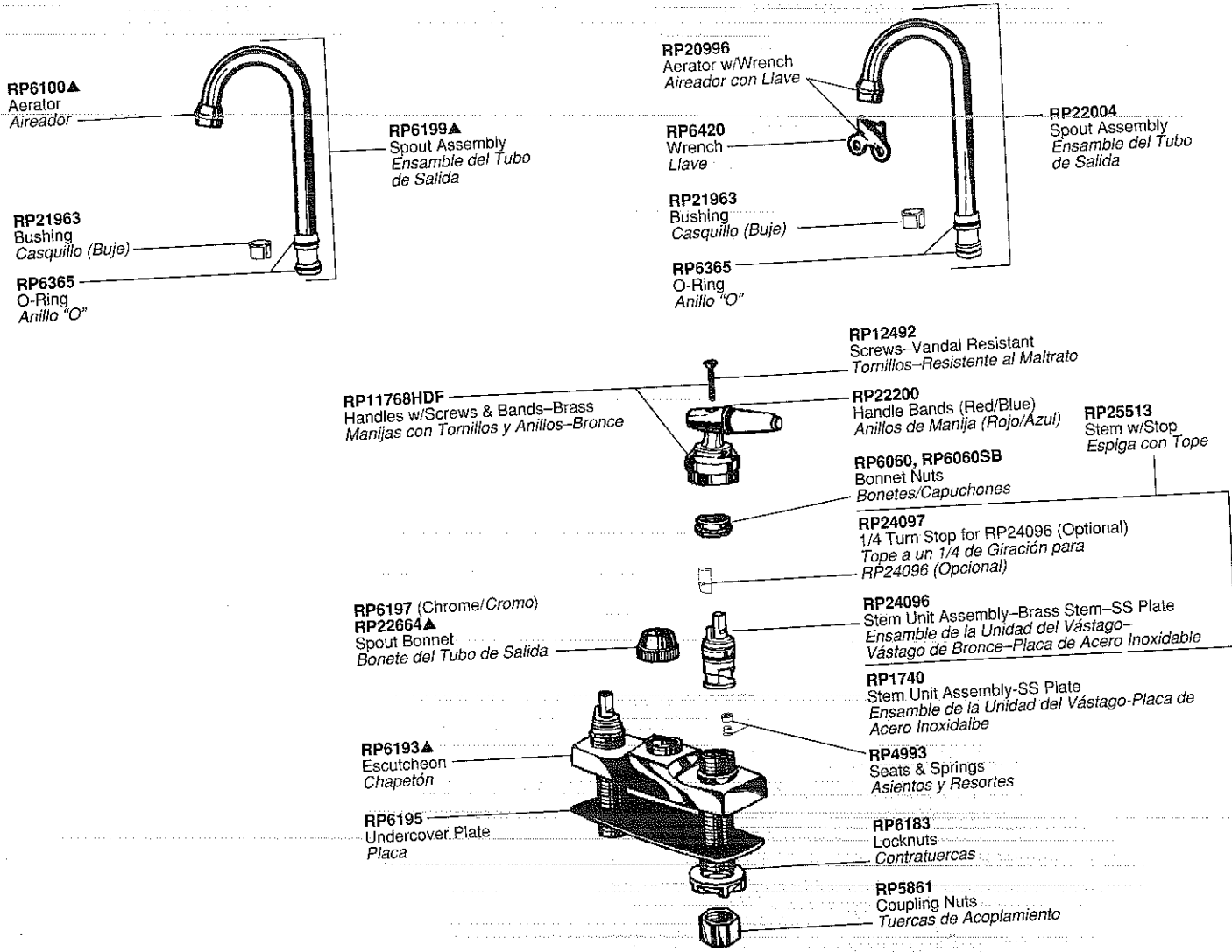

<p><b>OPTIONAL/OPCIONAL</b></p> <p><b>RP8230</b> Ceramic Stem Unit, Seat, O-Ring, Spring &amp; Screw Unidad del Vástago de Cerámica, Asiento, Anillo "O", Resorte y Tornillo</p> <p><b>RP10700</b> Ceramic Seats, O-Rings &amp; Springs Asientos de Cerámica, Anillos "O" y Resortes</p>	<p><b>H27, H27PB</b> Small Porcelain Cross Handles w/Screws Manijas de Cruz Pequeño de Porcelana con Tornillos</p> <p><b>RP25620</b> Set Screws Tornillos de Ajuste</p> <p><b>RP20185</b> Retention Screws Tornillos de Retención</p>	<p><b>H26, H26AC, H26AP, H26CB, H26PB, H26WC, H26WP</b> Small Metal Cross Handles w/Screws Manijas de Cruz, de Metal, Pequeñas con Tornillos</p> <p><b>RP25620</b> Set Screws Tornillos de Ajuste</p> <p><b>RP20185</b> Retention Screws Tornillos de Retención</p>
<p><b>RP21963</b> Ceramic Seats, O-Rings &amp; Springs Asientos de Cerámica, Anillos "O" y Resortes</p>	<p><b>H21, H21PB</b> Small Knob Handles w/Buttons &amp; Screws Manijas de Perilla Pequeña con Botones y Tornillos</p> <p><b>RP18373, RP18373PB</b> Button Set (Red/Blue Indicators) Botones (Indicadores Rojo/Azul)</p> <p><b>RP5885</b> Screws Tornillos</p>	<p><b>H28</b> Blade Handles w/Buttons &amp; Screws Manijas de Palanca con Botones y Tornillos</p> <p><b>RP2412</b> Button Set Botones</p> <p><b>RP5885</b> Screws Tornillos</p>

▲ Designate proper finish suffix. Verify available finishes in Miscellaneous Parts Section. **Note:** Chrome models have no finish suffix. AB=Antique Brass, AC=Almond/Chrome, AL=Almond, AP=Almond/Polished Brass, CB=Chrome/Polished Brass, PB=Polished Brass, WC=White/Chrome, WH=White, WP=White/Polished Brass.

▲ *Designe el sufijo apropiado para el acabado. Verifique acabados disponibles en la sección de Piezas Misceláneas. **Nota:** El acabado de los modelos de cromo no tienen sufijo. AB=Bronce Antiguo, AC=Almendra/Cromo, AL=Almendra, AP=Almendra/Bronce Pulido, CB=Cromo/Bronce Pulido, PB=Bronce Pulido, WC=Blanco/Cromo, WH=Blanco, WP=Blanco/Bronce Pulido.*

## Model/Modelo 2177 Series

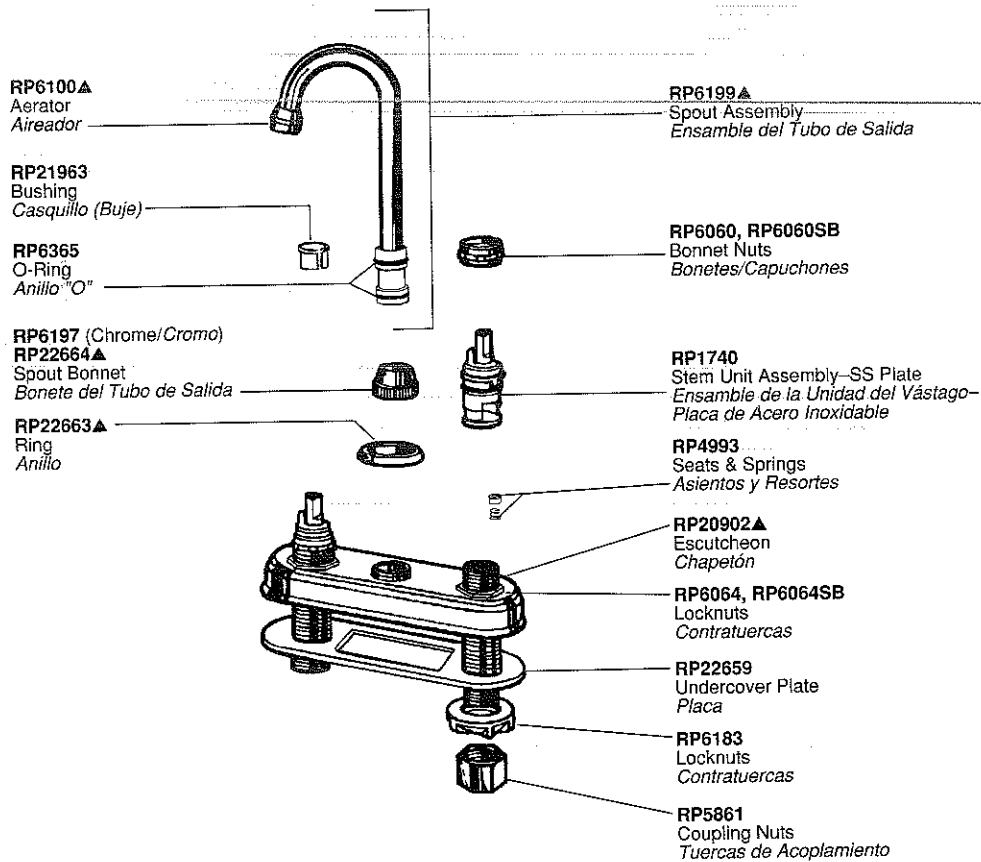

**H22, H22AB, H22AL, H22PB, H22WH**  
Small Lever Handles w/Screws  
Manijas Pequeña de Palanca con Tornillos

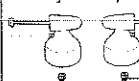

**RP25620**  
Set Screws/Tornillos de Ajuste

**RP20185**  
Retention Screws  
Tornillos de Retención

**A22, A22AB, A22AL, A22CL, A22OK, A22PB, A22PR, A22RS, A22WH, A22WW**  
Handle Accents/Acentos para Manijas

**H24, H24AL, H24PB, H24WH**  
Small Lever Handles w/Screws  
Manijas Pequeña de Palanca con Tornillos

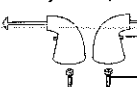

**RP25620**  
Set Screws/Tornillos de Ajuste

**RP20185**  
Retention Screws  
Tornillos de Retención

**A24, A24AL, A24CL, A24PB, A24WH**  
Handle Accents/Acentos para Manijas

**H23, H23AB, H23AL, H23PB, H23WH**  
Small Ring Handles w/Caps & Screws  
Manijas de Anillo Pequeño con Casquetes y Tornillos

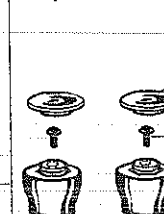

**RP18342, RP18342AB, RP18342AL, RP18342PB, RP18342WH**  
Handle Cap  
Casquete del Manija

**RP5885**  
Screws/Tornillos

**RP18340, RP18340AB, RP18340AL, RP18340PB, RP18340WH**  
Handle Base  
Base de la Manija

**H25, H25AC, H25AP, H25CA, H25CB, H25CW, H25CK, H25PA, H25PB, H25PK, H25PW, H25WC, H25WP**  
Small Lever Handles w/Screws  
Manijas de Pequeña de Palanca con Tornillos

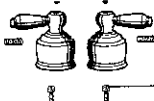

**RP25620**  
Set Screws/Tornillos de Ajuste

**RP20185**  
Retention Screws  
Tornillos de Retención

**RP12490**  
Screws—Vandal Resistant  
(Red/Blue)  
Tornillos—Resistente al  
Maltrato (Rojo/Azul)

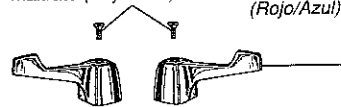

**RP12491**  
Wrist Blade Handles  
w/Screws (Red/Blue)  
Manijas Tipo Aleta  
con Tornillos  
(Rojo/Azul)

**A23, A23AB, A23AL, A23OK, A23PB, A23ST, A23WH**  
Handle Accents  
Acentos para Manijas

See Page 19 for Handle Suffix Chart/Vea la tabla en página 19 para más detalles sobre sufijos de manijas



# Single Handle Lavatory Faucets Llave (Mezcladora, Grifo) MonoControl para Lavamanos

Models/Modelos 502, 503, 504, 522 & 524 Series

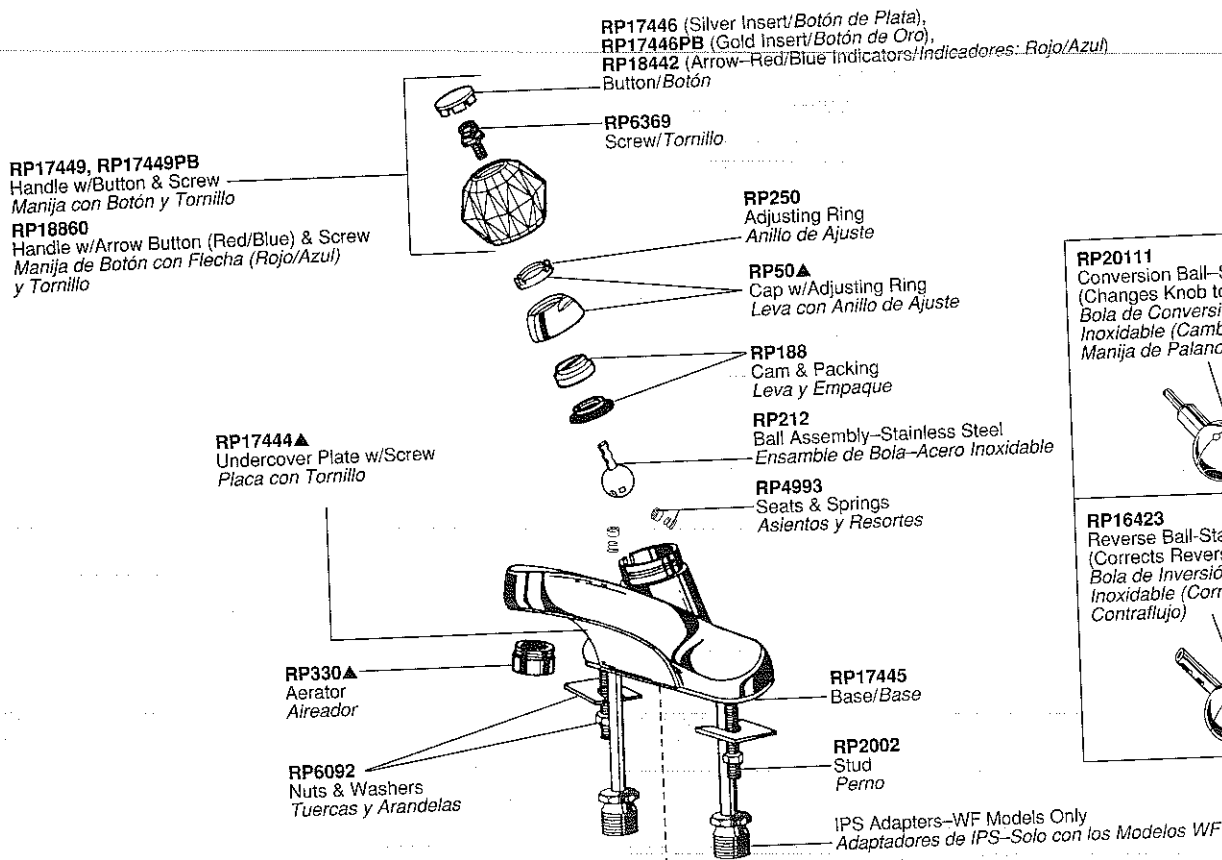

**RP20111**  
 Conversion Ball—Stainless Steel  
 (Changes Knob to Lever Handle)  
 Bola de Conversión—Acero  
 Inoxidable (Cambia de Perilla a  
 Manija de Palanca)

**RP16423**  
 Reverse Ball—Stainless Steel  
 (Corrects Reverse Supply Lines)  
 Bola de Inversión—Acero  
 Inoxidable (Corrige las Líneas de  
 Contraflujo)

**RP7584**  
 Chain & Stopper  
 Cadena y Tapón

**RP5861**  
 Coupling Nuts—WF Models Only  
 Tuercas de Acoplamiento—  
 Solo con los Modelos WF

For Models w/Notched Undercover Plate  
 Para Modelos con Placas Muecadas

**RP3614**  
 Repair-Kit  
 Equipo para Reparaciones

**RP1974**  
 Wrench—Handle/Adjusting Ring  
 Llave—Manija/Anillo de Ajuste

**504 & 524 Series**

**RP6183**  
 Locknuts  
 Contratuerzas

**RP5861**  
 Coupling Nuts  
 Tuercas de  
 Acoplamiento

**RP5651▲**  
 Pop-Up Assembly  
 Ensamble de Desagüe  
 Automático

**RP6463**  
 Pop-Up Assembly  
 Ensamble de Desagüe  
 Automático

Refer to pages 44 & 45 for lavatory drain assemblies.  
 Para ensambles de drenaje para lavamanos refiérase a la página 44 & 45.

▼ Designate proper finish suffix. Verify available finishes in Miscellaneous Parts Section. Note: Chrome models have no finish suffix. AB=Antique Brass, PB=Polished Brass, WC=White/Chrome, WP=White/Polished Brass, CB=Chrome/Polished Brass, AL=Almond, CB=Chrome/Polished Brass. Pulido, PB=Bronce Pulido, WC=Blanco/Cromo, WP=Blanco/Bronce Pulido. como no tienen sufixo. AB=Bronce Antiguo, AL=Almendra, CB=Cromo/Bronce en la sección de Piezas Misceláneas. Nota: El acabado de los modelos de ▼ Designe el sufixo apropiado para el acabado. Verifique acabados disponibles

**Models/Modelos 500, 501, 505, 511, 515, 516, 520, 523 & 525 Series**

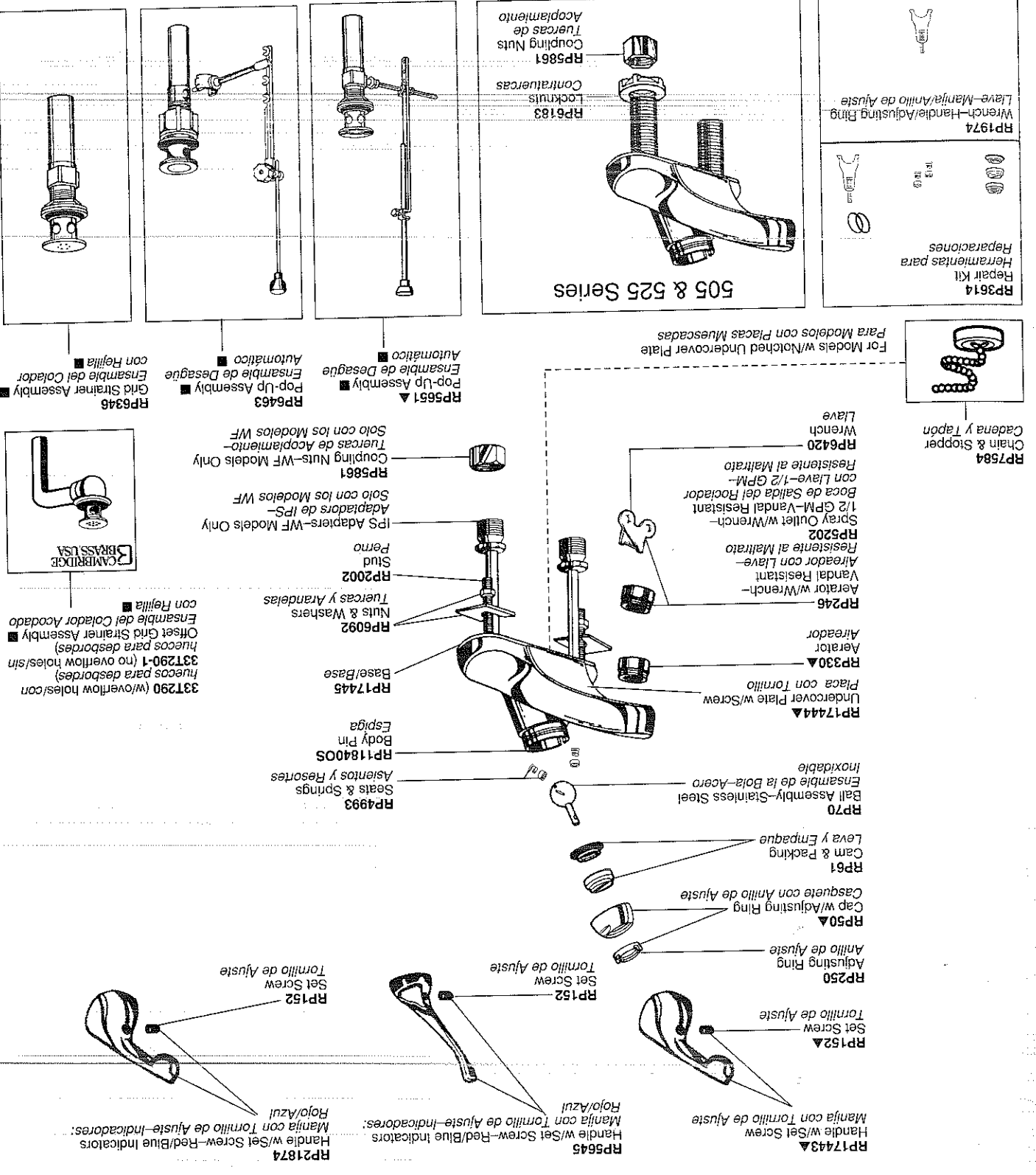

For Models w/Notched Undercover Plate  
 Para Modelos con Fajas Muscadas

- RP5651 ▲ Pop-Up Assembly - Ensamble de Desagüe Automático
- RP6463 Pop-Up Assembly - Ensamble de Desagüe Automático
- RP6346 Grid Strainer Assembly - Ensamble del Colador con Fejilla



- RP4993 Seats & Springs - Asientos y Resortes
- RP184005 Body Pin - Espiga
- RP17445 Base/Base - Base/Asiento
- RP6092 Nuts & Washers - Tuercas y Arandelas
- RP2002 Stud - Perno
- RP5861 IPS Adapters-WF Models Only - Adaptadores de IPS Solo con los Modelos WF
- RP5861 Coupling Nuts-WF Models Only - Tuercas de Acoplamiento Solo con los Modelos WF

- RP17444 ▲ Undercover Plate w/Screw - Placa con Tornillo
- RP330 ▲ Aerator - Aireador
- RP246 Aerator w/Wrench - Aireador con Llave
- RP246 Spray Outlet w/Wrench - Boca de Salida del Rocador
- RP5202 Vandal Resistant 1/2 GPM-Wrench - Resistente al Maltrato con Llave-1/2 GPM
- RP6420 Wrench - Resistente al Maltrato con Llave

- RP70 Ball Assembly-Stainless Steel - Ensamble de la Bola-Acero Inoxidable
- RP250 Adjusting Ring - Anillo de Ajuste
- RP50 ▲ Cap w/Adjusting Ring - Casquete con Anillo de Ajuste
- RP61 Cam & Packing - Leva y Empaque
- RP152 ▲ Set Screw - Tornillo de Ajuste
- RP152 ▲ Set Screw - Tornillo de Ajuste
- RP17443 ▲ Handle w/Set Screw - Manija con Tornillo de Ajuste
- RP5645 Handle w/Set Screw-Red/Blue Indicators - Manija con Tornillo de Ajuste-Indicadores Rojo/Azul
- RP21874 Handle w/Set Screw-Red/Blue Indicators - Manija con Tornillo de Ajuste-Indicadores Rojo/Azul

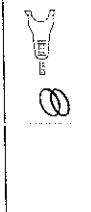
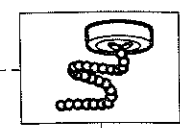
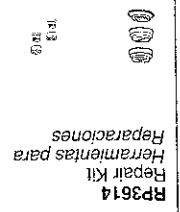

RP1974 Wrench-Adjusting Ring - Llave-Manija/Anillo de Ajuste

505 & 525 Series

- RP5861 Coupling Nuts - Tuercas de Acoplamiento
- RP5183 Locknuts - ContraTuercas

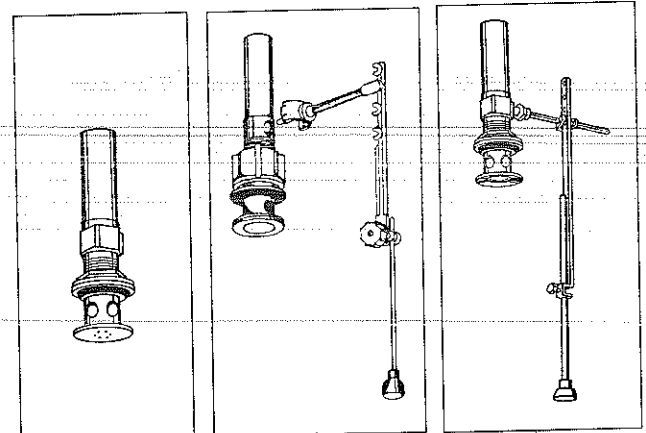

# Single Handle Lavatory Faucets Llave (Mezcladora) MonoControl para Lavamanos

Models/Modelos 550 & 552 Series

RP17446 (Silver Insert/Botón de Plata),  
RP17446PB (Gold Insert/Botón de Oro),  
RP18442 (Arrow-Red/Blue Indicators/  
Flecha-Indicadores: Rojo/Azul)  
Button/Botón

RP6369  
Screw  
Tornillo

RP18015, RP18015PB  
Spout Assembly  
Ensamble del Tubo de Salida

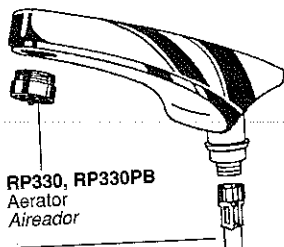

RP330, RP330PB  
Aerator  
Aireador

RP18026  
Shank  
Espiga

RP17445  
Gasket  
Empaque

RP6183  
Locknut  
Contratuercas

RP5869  
Nut & Washer  
Tuerca y Arandela

RP18011  
Hose  
Manguera

RP18054  
Hook-Up Kit  
Equipo para Conexión

RP18145  
Adapters & Gaskets  
Adaptadores y Empaques

RP5861  
Coupling Nuts  
Tuercas de Acoplamiento

RP17449, RP17449PB  
Handle w/Button & Screw  
Manija con Botón y Tornillo

RP18860  
Handle w/Arrow Button (Red/Blue)  
& Screw  
Manija de Botón con Flecha  
(Rojo/Azul) y Tornillo

RP250  
Adjusting Ring  
Anillo de Ajuste

RP50, RP50PB  
Cap w/Adjusting Ring  
Casquete con Anillo de Ajuste

RP188  
Cam & Packing  
Leva y Empaque

RP18037 ●  
Vacuum Breaker Ball Assembly—Stainless Steel  
Ensamble de Bola con Rompevacío—Acero Inoxidable

RP4993  
Seats & Springs  
Asientos y Resortes

RP18027, RP18027PB  
Rod Guide  
Guía para la Barra

RP118400S  
Body Pin for Model 550  
Espiga para Modelo 550

RP17443, RP17443PB  
Handle w/Set Screw  
Manija con Tornillo de Ajuste

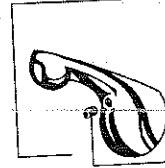

RP152  
Set Screw  
Tornillo de Ajuste

RP61  
Cam & Packing  
Leva y Empaque

RP12301 ●  
Vacuum Breaker Ball  
Assembly—Stainless Steel  
Ensamble de la Bola con  
Rompevacío—Acero Inoxidable

RP5651, RP5651PB  
Pop-Up Assembly  
Ensamble de Desagüe  
Automático

RP3614  
Repair Kit  
Herramientas para  
Reparaciones

RP1974  
Wrench—Handle/Adjusting Ring  
Llave—Manija/Anillo de Ajuste

● The vacuum breaker-ball assembly is an important part of protecting your drinking water from contamination by back siphonage. Use only the Delta RP18037 or RP12301 ball assembly.

■ Refer to pages 44 & 45 for lavatory drain assemblies. Para ensamble de drenaje para lavamanos refiérase a la páginas 44 y 45.

● El ensamble de bola con rompevacío es una parte importante en proteger su agua potable de contaminación por causa del retrocedimiento de agua. Use sólo el ensamble de bola Delta RP18037 o RP12301.

# Models / Modelos 570 & 575 Series

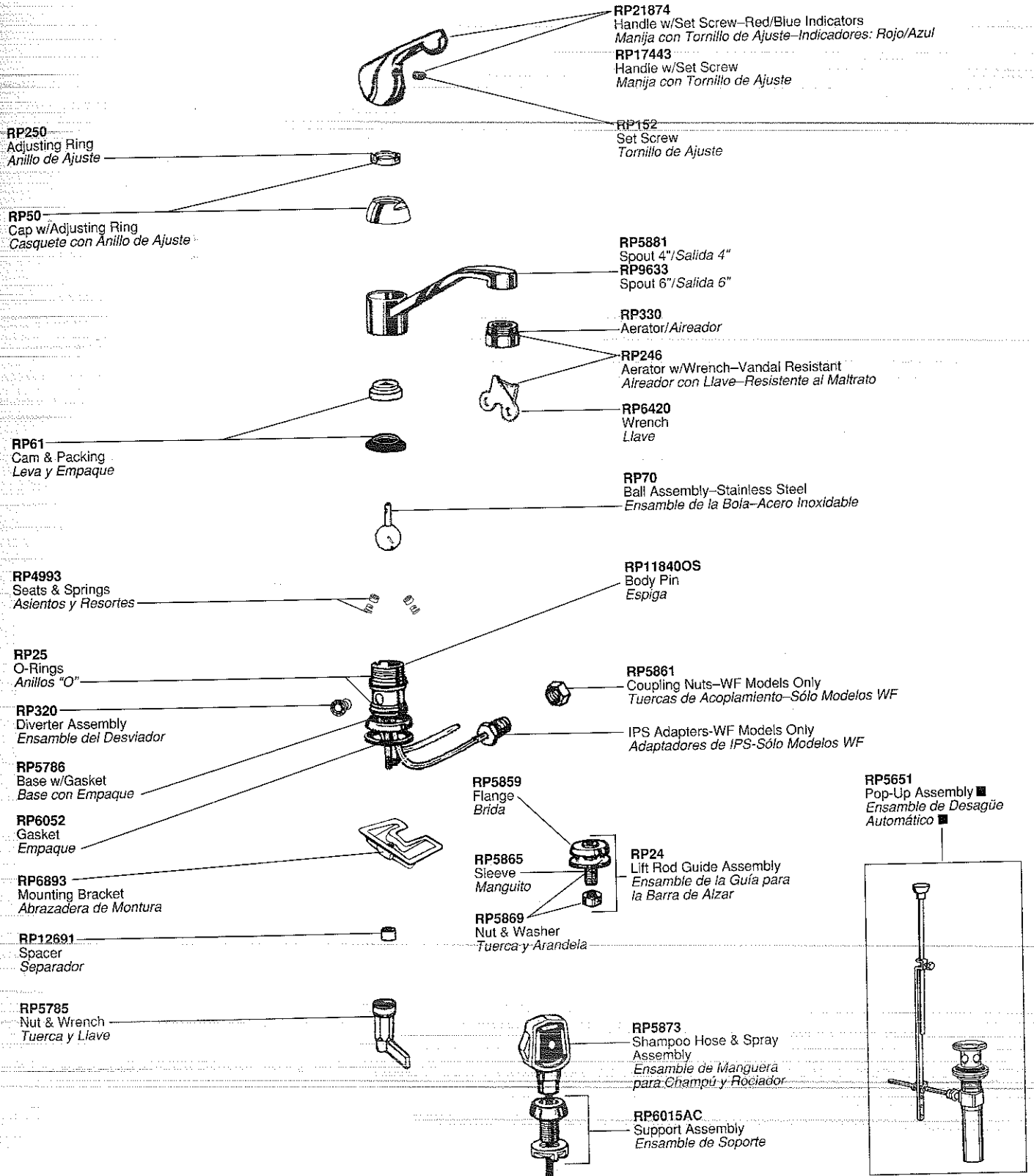

■ Refer to pages 44 & 45 for lavatory drain assemblies.  
Para ensamble de drenaje para lavamanos refiérase a la páginas 44 y 45.

# Two Handle Lavatory Faucets Llave de Dos Manijas (Manerales) para Lavamanos

Models/Modelos 2500, 2502 & 2520 Series

**RP22200**  
Handle Bands (Red/Blue)  
Anillos para Manijas (Rojo/Azul)

**RP12492**  
Screws—Vandal Resistant  
Tornillos—Resistente al Maltrato

**RP11768HDF**  
Handles w/Screws & Bands—Brass  
Manijas con Tornillos y Anillos—Bronce

**RP25513**  
Stem w/Stop  
Espiga con Tope

**RP24097**  
1/4 Turn Stop for RP24096 (Optional)  
Tope a un 1/4 de Giración para  
RP24096 (Opcional)

**RP24096**  
Stem Unit Assembly—Brass Stem-SS Plate  
Ensamble de la Unidad del Vástago—  
Vástago de Bronce-Placa de Acero Inoxidable

**RP1740**  
Stem Unit Assembly—SS Plate  
Ensamble de la Unidad del Vástago—  
Placa de Acero Inoxidable

**RP330▲**  
Aerator  
Aireador

**RP246**  
Aerator w/Wrench—  
Vandal Resistant  
Aireador con Llave—  
Resistente al Maltrato

**RP5202**  
Spray Outlet w/Wrench—  
1/2 GPM—Vandal Resistant  
Boca de Salida del Rociador  
con Llave—1/2 GPM—  
Resistente al Maltrato

**RP6420**  
Wrench  
Llave

**RP19420**  
Gasket  
Empaque

**RP6183**  
Locknuts  
Contratuercas

**RP5861**  
Coupling Nuts  
Tuercas de Acoplamiento

**RP6060, RP6060SB**  
Bonnet Nuts  
Bonetes/Capuchones

**RP4993**  
Seats & Springs  
Asientos y Resortes

**RP6068**  
Button  
Botón

**RP6064, RP6064SB**  
Locknuts  
Contratuercas

**RP19119**  
Undercover Plate  
Placa

**RP7584**  
Chain & Stopper (For models  
w/notched undercover plate)  
Cadena y Tapón (Para mode-  
los con placas muescadas)

**33T290** (w/overflow holes/con  
huecos para desbordes)  
**33T290-1** (no overflow holes/sin  
huecos para desbordes)  
Offset Grid Strainer Assembly  
Ensamble del Colador Acodado  
con Rejilla

**RP6346**  
Grid Strainer Assembly  
Ensamble del Colador  
con Rejilla

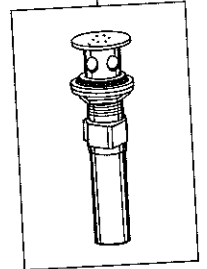
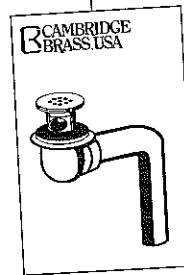

**RP5651▲**  
Pop-Up Assembly  
Ensamble del Desagüe  
Automático

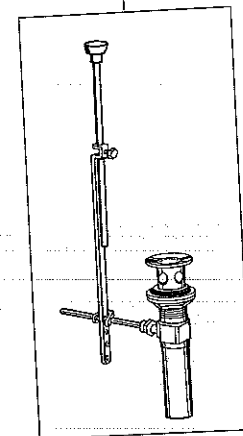

**RP6463**  
Pop-Up Assembly  
Ensamble del Desagüe  
Automático

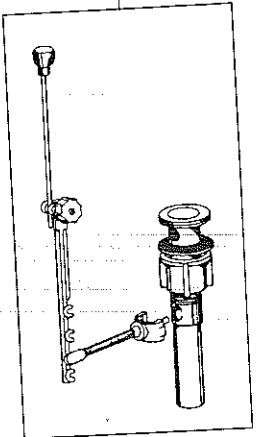

Refer to pages 44 & 45 for lavatory drain assemblies. Para ensamble de drenaje para lavamanos refiérase a la páginas 44 y 45.

**OPTIONAL/OPCIONAL**



**RP8230**  
Ceramic Stem Unit, Seat,  
O-Ring, Spring & Screw  
Unidad del Vástago de Cerámica,  
Asiento, Anillo "O", Resorte y Tornillo

**RP10700**  
Ceramic Seats, O-Rings & Springs  
Asientos de Cerámica, Anillos "O" y  
Resortes

**H27, H27PB**  
Small Porcelain Cross Handles w/Screws  
Manijas de Cruz Pequeño de Porcelana con Tornillos



**RP25620**  
Set Screws  
Tornillos de Ajuste

**RP20185**  
Retention Screws  
Tornillos de Retención

**H26, H26AC, H26AP, H26CB, H26PB, H26WC, H26WP**  
Small Metal Cross Handles w/Screws  
Manijas de Cruz de Metal Pequeño con Tornillos

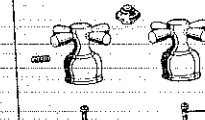

**RP25620**  
Set Screws  
Tornillos de Ajuste

**RP20185**  
Retention Screws  
Tornillos de Retención

**H21, H21PB**  
Small Knob Handles w/Buttons & Screws  
Manijas de Perilla Pequeña con Botones y Tornillos

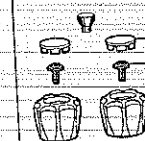

**RP18373, RP18373PB**  
Button Set (Red/Blue Indicators)  
Botones (Indicadores: Rojo/Azul)

**RP5885**  
Screws  
Tornillos

**H28**  
Blade Handles w/Buttons & Screws  
Manijas de Palanca con Botones y Tornillos

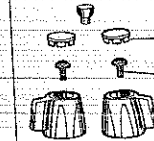

**RP2412**  
Button Set  
Botones

**RP5885**  
Screws  
Tornillos

▲ Designate proper finish suffix. Verify available finishes in Miscellaneous Parts Section. **Note:** Chrome models have no finish suffix. AB=Antique Brass, AL=Almond, CB=Chrome/Polished Brass, PB=Polished Brass, WH=White.

▲ Designe el sufijo apropiado para el acabado. Verifique acabados disponibles en la sección de Piezas Misceláneas. **Nota:** El acabado de los modelos de cromo no tienen sufijo. AB=Bronce Antiguo, AL=Almendra, CB=Cromo/Bronce Pulido, PB=Bronce Pulido, WH=Blanco.

# Model/Modelo 2530 Series

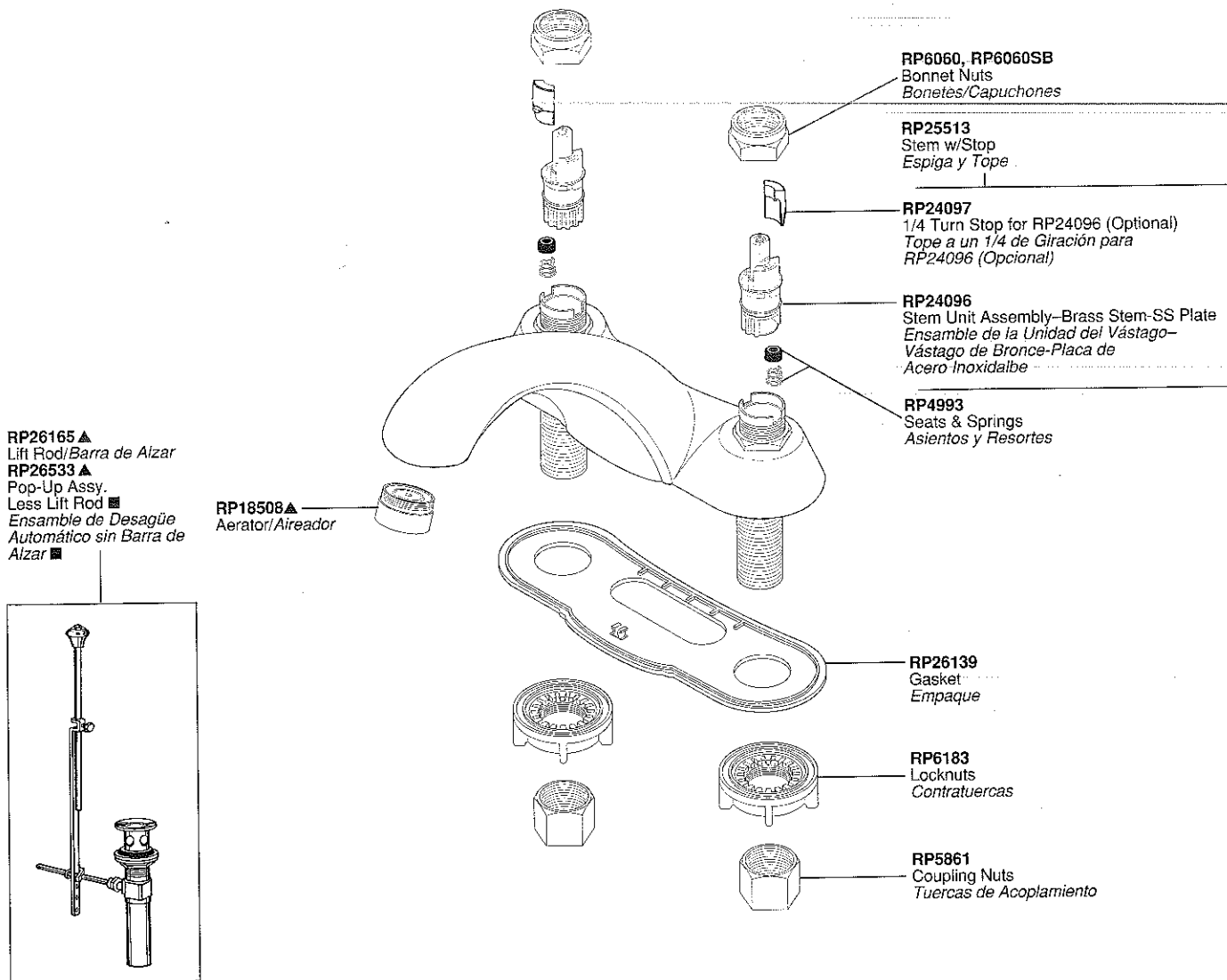

■ Refer to pages 44 & 45 for lavatory drain assemblies. Para ensamble de drenaje para lavamanos refiérase a la páginas 44 y 45.

<p><b>H22, H22AB, H22AL, H22PB, H22WH</b> Small Lever Handles w/Screws Manijas Pequeñas de Palanca con Tornillos</p> <p><b>RP25620</b> Set Screws/Tornillos de Ajuste</p> <p><b>RP20185</b> Retention Screws Tornillos de Retención</p> <p><b>A22, A22AB, A22AL, A22CL, A22OK, A22PB, A22PR, A22RS, A22WH, A22WW</b> Handle Accents w/Finial Acces. Manijas/Botón/Barra Desagüe</p>	<p><b>H24, H24AL, H24PB, H24WH</b> Small Lever Handles w/Screws Manijas Pequeña de Palanca con Tornillos</p> <p><b>RP25620</b> Set Screws/Tornillos de Ajuste</p> <p><b>RP20185</b> Retention Screws Tornillos de Retención</p> <p><b>A24, A24AL, A24CL, A24PB, A24WH</b> Handle Accents w/Finial Acces. Manijas/Botón/Barra Desagüe</p>	<p><b>H23, H23AB, H23AL, H23PB, H23WH</b> Small Ring Handles w/Caps &amp; Screws Manijas de Anillo Pequeña con Casquetes y Tornillos</p> <p><b>RP18342, RP18342AB, RP18342AL, RP18342PB, RP18342WH</b> Handle Cap Casquete de la Manija</p> <p><b>RP5885</b> Screws/Tornillos</p> <p><b>RP18340, RP18340AB, RP18340AL, RP18340PB, RP18340WH</b> Handle Base Base de la Manija</p>
<p><b>H25, H25AC, H25AP, H25CA, H25CB, H25CW, H25CK, H25PA, H25PB, H25PK, H25PW, H25WC, H25WP</b> Small Lever Handles w/Screws Manijas de Pequeña de Palanca con Tornillos</p> <p><b>RP25620</b> Set Screws/Tornillos de Ajuste</p> <p><b>RP20185</b> Retention Screws Tornillos de Retención</p>	<p><b>RP12490</b> Screws—Vandal-Resistant (Red/Blue) Tornillos—Resistente al Maltrato (Rojo/Azul)</p> <p><b>RP12491</b> Wrist Blade Handles w/Screws (Red/Blue) Manijas Tipo Aleta con Tornillos (Rojo/Azul)</p>	<p><b>A23, A23AB, A23AL, A23OK, A23PB, A23ST, A23STAB, A23STAL, A23STPB, A23STWH, A23SWH</b> Handle Accents w/Finial Accesorios de Manijas con Botón para la Barra del Desagüe</p>

See Page 19 for Handle Suffix Chart/Vea la tabla en página 19 para más detalles sobre sufijos de manijas

# Two Handle Lavatory Faucets Llave de Dos Manijas (Manerales) para Lavamanos

Model/Modelo 2567 Series

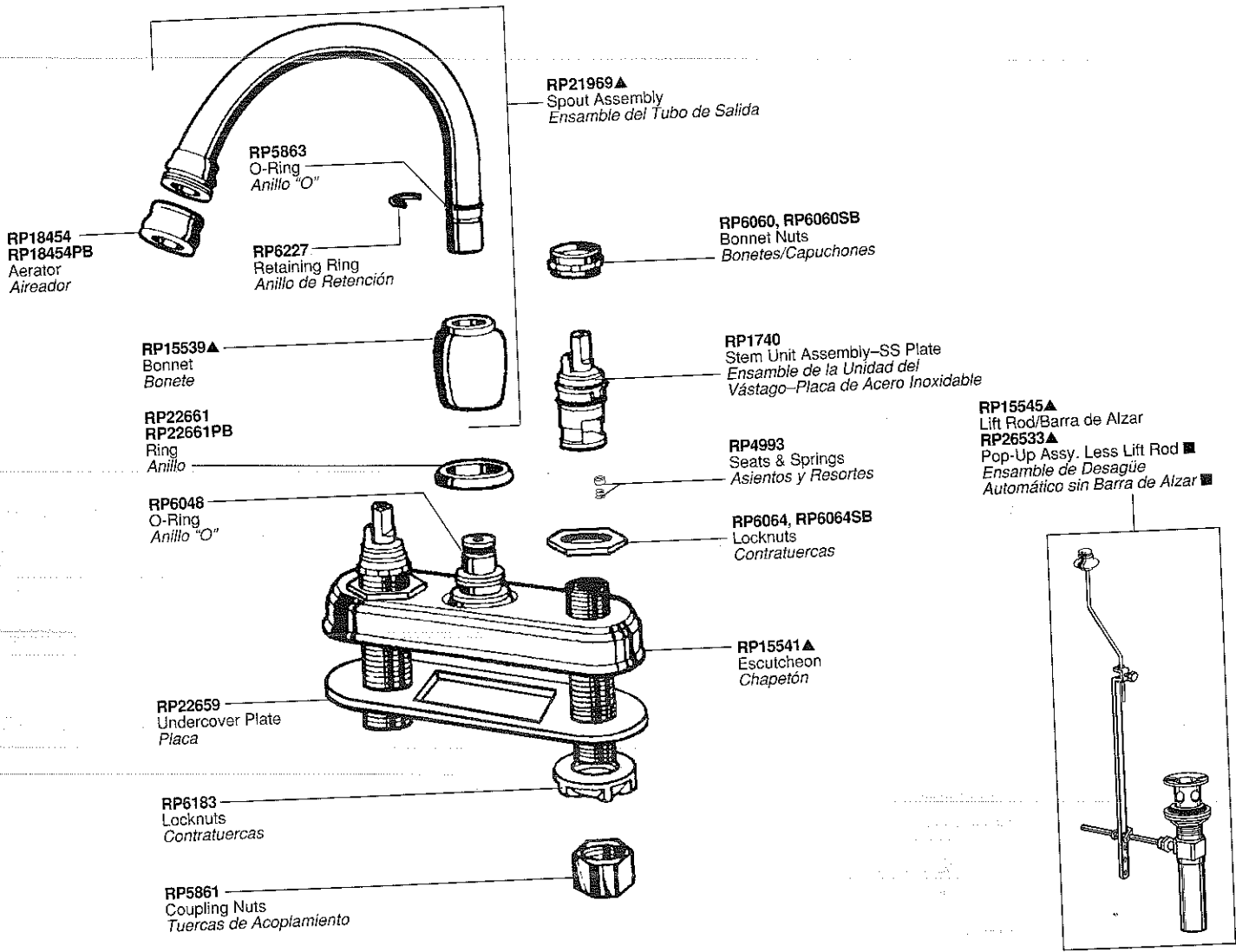

■ Refer to pages 44 & 45 for lavatory drain assemblies. Para ensamble de drenaje para lavamanos refiérase a la páginas 44 y 45.

See Page 19 for Handle Suffix Chart/Vea la tabla en página 19 para más detalles sobre sufijos de manijas.

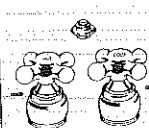
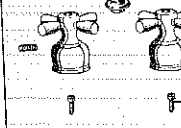
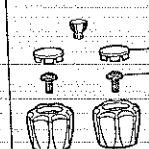
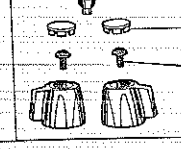
<p><b>H27, H27PB</b> Small Porcelain Cross Handles w/Screws Manijas de Cruz Pequeña de Porcelana con Tornillos.</p>  <p><b>RP25620</b> Set Screws Tornillos de Ajuste</p> <p><b>RP20185</b> Retention Screws Tornillos de Retención</p>	<p><b>H26, H26AC, H26AP, H26CB, H26PB, H26WC, H26WP</b> Small Metal Cross Handles w/Screws Manijas de Cruz de Metal Pequeño con Tornillos</p>  <p><b>RP25620</b> Set Screws Tornillos de Ajuste</p> <p><b>RP20185</b> Retention Screws Tornillos de Retención</p>
<p><b>H21, H21PB</b> Small Knob Handles w/Buttons &amp; Screws Manijas de Perilla Pequeña con Botones y Tornillos</p>  <p><b>RP18373, RP18373PB</b> Button Set (Red/Blue Indicators) Botones (Indicadores: Rojo/Azul)</p> <p><b>RP5885</b> Screws Tornillos</p>	<p><b>H28</b> Blade Handles w/Buttons &amp; Screws Manijas de Aleta Pequeña con Botones y Tornillos</p>  <p><b>RP2412</b> Button Set Botones</p> <p><b>RP5885</b> Screws Tornillos</p>

▲ Designate proper finish suffix. Verify available finishes in Miscellaneous Parts Section. **Note:** Chrome models have no finish suffix. AC=Almond/Chrome, AL=Almond, AP=Almond/Polished Brass, CB=Chrome/Polished Brass, PB=Polished Brass, WC=White/Chrome, WH=White, WP=White/Polished Brass.

▲ Designe el sufijo apropiado para el acabado. Verifique acabados disponibles en la sección de Piezas Misceláneas. **Nota:** El acabado de los modelos de cromo no tienen sufijo. AC=Almendra/Cromo, AL=Almendra, AP=Almendra/Bronce Pulido, CB=Cromo/Bronce Pulido, PB=Bronce Pulido, WC=Blanco/Cromo, WH=Blanco, WP=Blanco/Bronce Pulido.

## Model/Modelo 2576\* Series

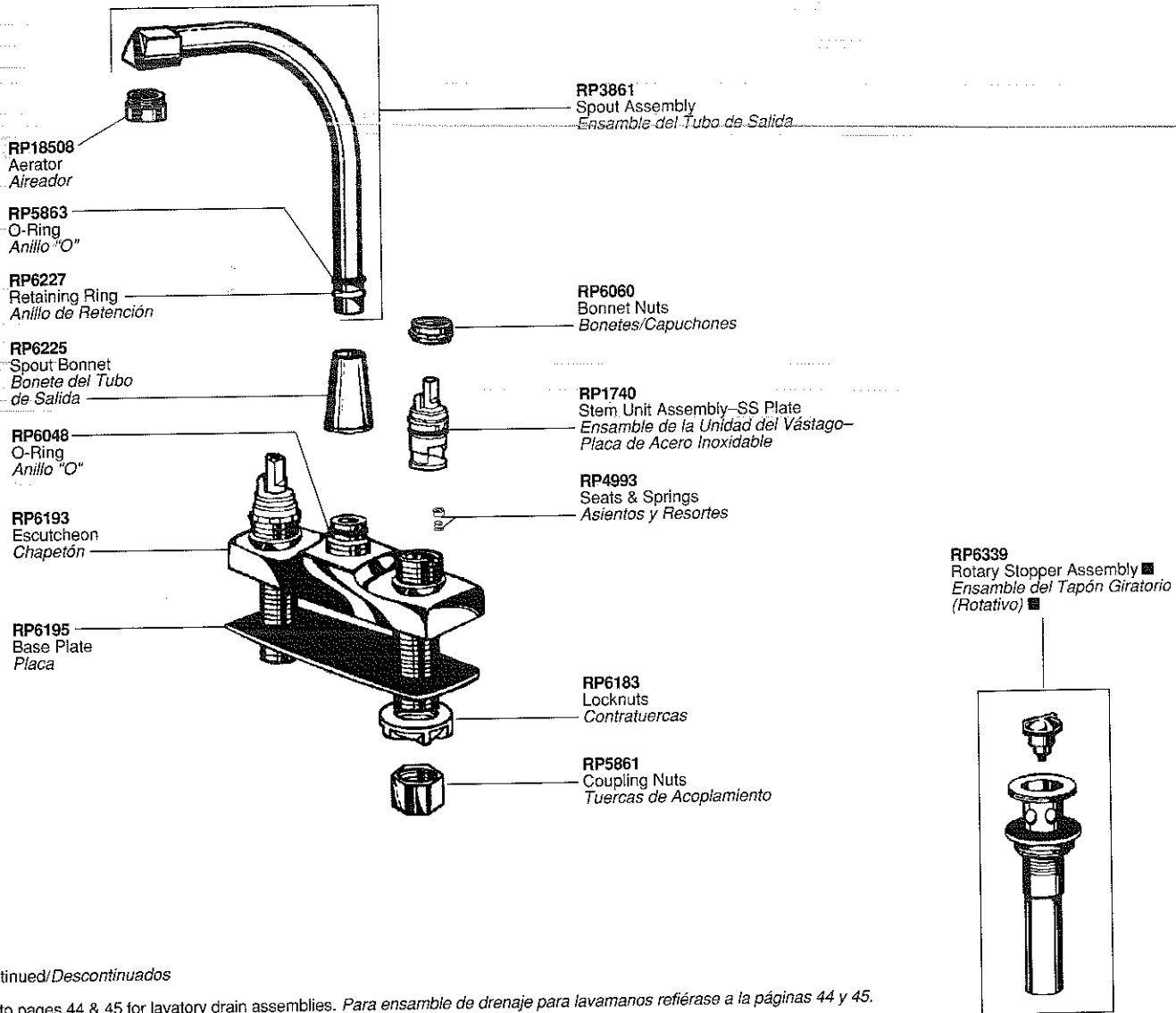

\*Discontinued/Descontinuados

■ Refer to pages 44 & 45 for lavatory drain assemblies. Para ensamble de drenaje para lavamanos refiérase a la páginas 44 y 45.

<p><b>H22, H22AB, H22AL, H22PB, H22WH</b> Small Lever Handles w/Screws Manijas Pequeña de Palanca con Tornillos</p> <p>RP25620 Set Screws/Tornillos de Ajuste</p> <p>RP20185 Retention Screws Tornillos de Retención</p> <p>A22, A22AB, A22AL, A22CL, A22OK, A22PB, A22PR, A22RS, A22WH, A22WW Handle Accents w/Finial Acces. Manijas/Botón/Barra del Desaghe</p>	<p><b>H24, H24AL, H24PB, H24WH</b> Small Lever Handles w/Screws Manijas Pequeña de Palanca con Tornillos</p> <p>RP25620 Set Screws/Tornillos de Ajuste</p> <p>RP20185 Retention Screws Tornillos de Retención</p> <p>A24, A24AL, A24CL, A24PB, A24WH Handle Accents w/Finial Acces. Manijas/Botón/Barra Desaghe</p>	<p><b>H23, H23AB, H23AL, H23PB, H23WH</b> Small Ring Handles w/Caps &amp; Screws Manijas de Anillo Pequeña con Casquetes y Tornillos</p> <p>RP18342, RP18342AB, RP18342AL, RP18342PB, RP18342WH Handle Cap Casquete de la Manija</p> <p>RP5885 Screws/Tornillos</p> <p>RP18340, RP18340AB, RP18340AL, RP18340PB, RP18340WH Handle Base Base de la Manija</p>
<p><b>H25, H25AC, H25AP, H25CA, H25CB, H25CW, H25CK, H25PA, H25PB, H25PK, H25PW, H25WC, H25WP</b> Small Lever Handles w/Screws Manijas de Pequeña de Palanca con Tornillos</p> <p>RP25620 Set Screws/Tornillos de Ajuste</p> <p>RP20185 Retention Screws Tornillos de Retención</p>	<p><b>RP12490</b> Screws-Vandal-Resistant (Red/Blue) Tornillos-Resistente al Maltrato (Rojo/Azul)</p> <p><b>RP12491</b> Wrist Blade Handles w/Screws (Red/Blue) Manijas Tipo Aleta con Tornillos (Rojo/Azul)</p>	<p>A23, A23AB, A23AL, A23OK, A23PB, A23ST, A23STAB, A23STAL, A23STPB, A23STWH, A23WH Handle Accents w/Finial Accesorios de Manijas con Botón para la Barra del Desaghe</p>

See Page 19 for Handle Suffix Chart/Vea la tabla en página 19 para más detalles sobre sufijos de manijas.



# Two Handle Lavatory Faucets Llave de Dos Manijas (Manerales) para Lavamanos

Model/Modelo 2581\* Series

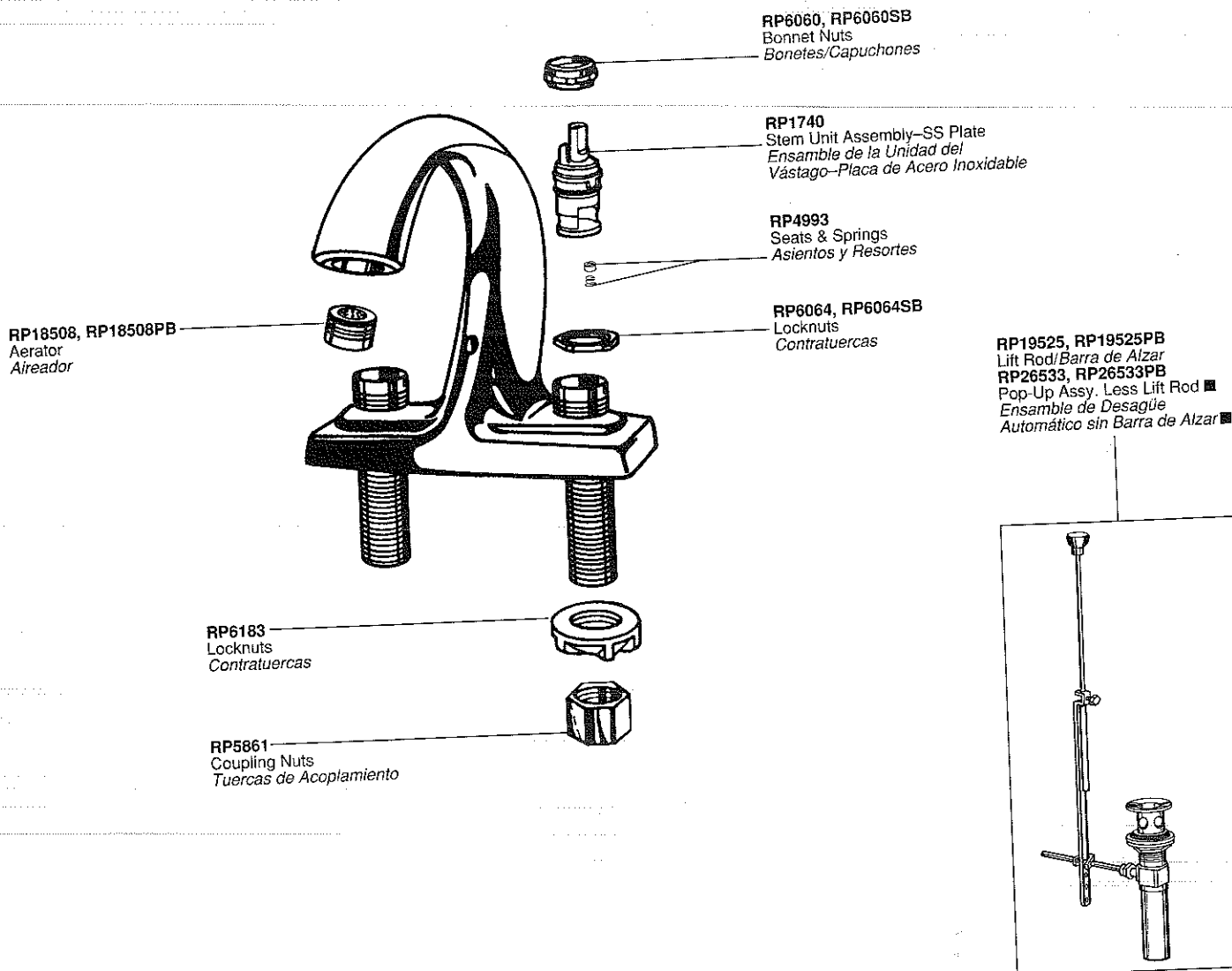

\*Discontinued/Descontinuados

Refer to pages 44 & 45 for lavatory drain assemblies. Para ensamble de drenaje para lavamanos refiérase a la páginas 44 y 45.

**OPTIONAL/OPCIONAL**



**RP8230**  
Ceramic Stem Unit, Seat, O-Ring, Spring & Screw  
Unidad del Vástago de Cerámica, Asiento, Anillo "O", Resorte y Tornillo

**RP10700**  
Ceramic Seats, O-Rings & Springs  
Asientos de Cerámica, Anillos "O" y Resortes

**H27, H27PB**  
Small Porcelain Cross Handles w/Screws  
Manijas de Cruz Pequeño de Porcelana con Tornillos

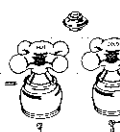

**RP25620**  
Set Screws  
Tornillos de Ajuste

**RP20185**  
Retention Screws  
Tornillos de Retención

**H21, H21PB**  
Small Knob Handles w/Buttons & Screws  
Manijas de Perilla Pequeña con Botones y Tornillos

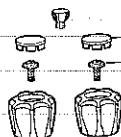

**RP18373, RP18373PB**  
Button Set (Red/Blue Indicators)  
Botones (Indicadores: Rojo/Azul)

**RP5885**  
Screws  
Tornillos

**H26, H26AC, H26AP, H26CB, H26PB, H26WC, H26WP**  
Small Metal Cross Handles w/Screws  
Manijas de Cruz de Metal Pequeño con Tornillos



**RP25620**  
Set Screws  
Tornillos de Ajuste

**RP20185**  
Retention Screws  
Tornillos de Retención

**H28**  
Blade Handles w/Buttons & Screws  
Manijas de Palanca con Botones y Tornillos

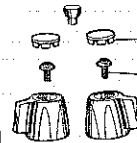

**RP2412**  
Button Set  
Botones

**RP5885**  
Screws  
Tornillos

See Page 19 for Handle Suffix Chart/Vea la tabla en página 19 para mas detalles sobre sufijos de manijas.

# Models/Modelos 2593-HDF & 2599-HDF Series

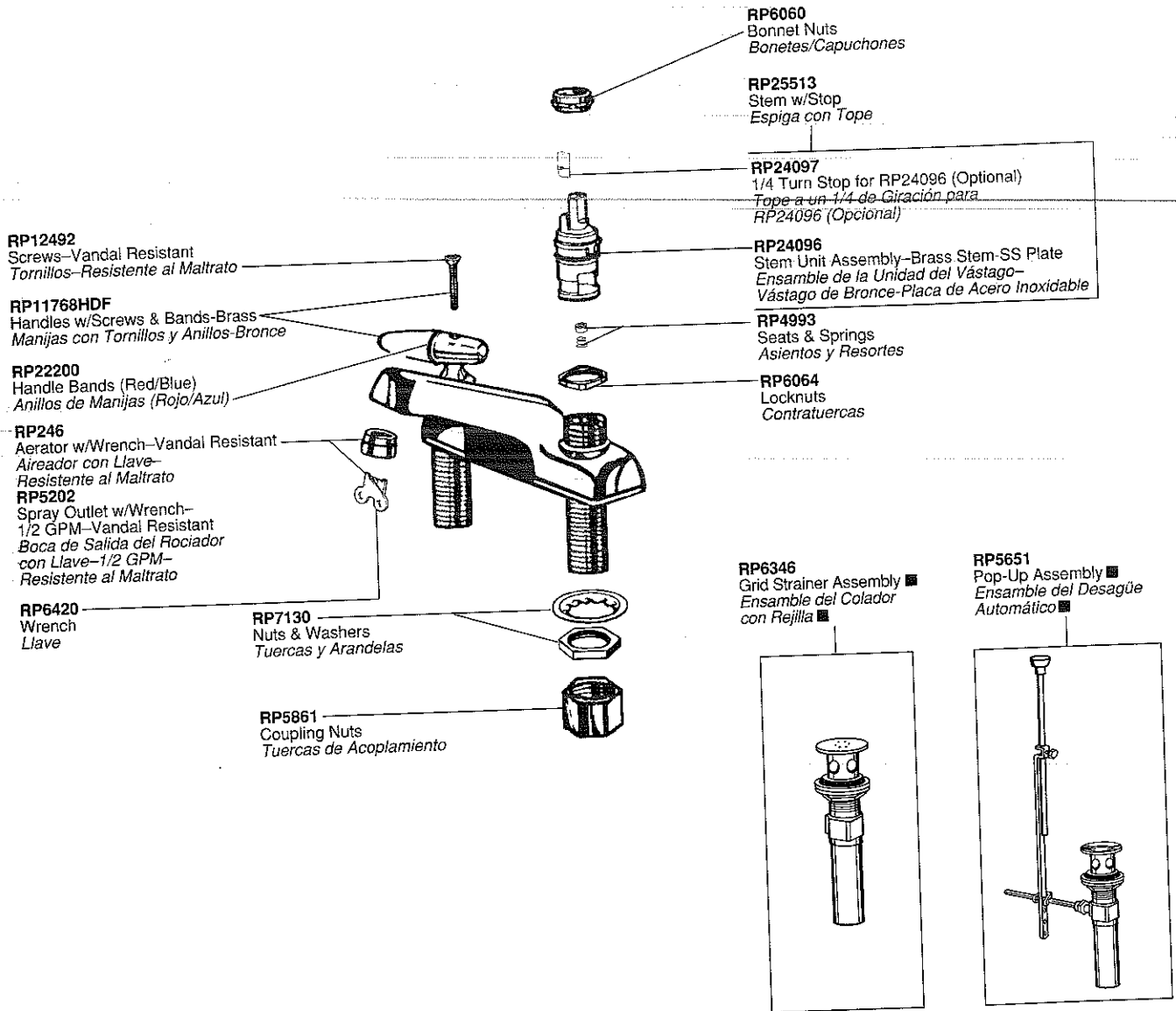

Refer to pages 44 & 45 for lavatory drain assemblies. Para ensamble de drenaje para lavamanos refiérase a la páginas 44 y 45.

**H22, H22AB, H22AL, H22PB, H22WH**  
Small Lever Handles w/Screws  
Manijas Pequeña de Palanca con Tornillos



**A22, A22AB, A22AL, A22CL, A22OK, A22PB, A22PR, A22RS, A22WH, A22WW**  
Handle Accents w/Finial  
Acces. Manijas/Botón para Barra Desaghe



**H24, H24AL, H24PB, H24WH**  
Small Lever Handles w/Screws  
Manijas Pequeña de Palanca con Tornillos

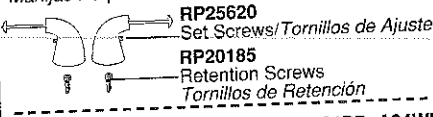

**A24, A24AL, A24CL, A24PB, A24WH**  
Handle Accents w/Finial  
Acces. Manijas/Botón Barra Desaghe

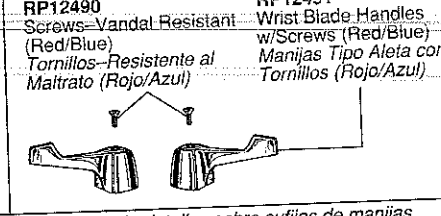

**H23, H23AB, H23AL, H23PB, H23WH**  
Small Ring Handles w/Caps & Screws  
Manijas de Anillo Pequeña con Casquetes y Tornillos

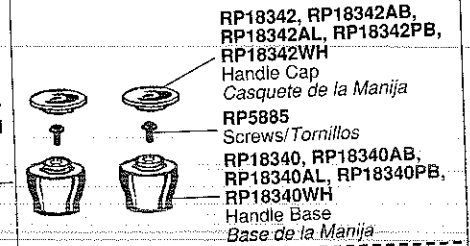

**A23, A23AB, A23AL, A23OK, A23PB, A23ST, A23STAB, A23STAL, A23STPB, A23STWH, A23WH**  
Handle Accents w/Finial  
Accesorios de Manijas con Botón para la Barra del Desaghe

See Page 19 for Handle Suffix Chart/Vea la tabla en página 19 para más detalles sobre sufixos de manijas.

# Two Handle Lavatory Faucets Llave de Dos Manijas (Manerales) para Lavamanos

Models/Modelos 3501-HDF & 3509-HDF Series

**RP5202**  
Spray Outlet w/Wrench—  
1/2 GPM—Vandal Resistant  
Boca de Salida del Rociador con  
Llave—1/2 GPM—  
Resistente al Maltrato

**RP246**  
Aerator w/Wrench—Vandal Resistant  
Aerador con Llave—  
Resistente al Maltrato

**RP20665**  
Spout Assembly—Vandal Resistant Aerator—  
No Lift Rod Hole  
Ensamble de la Salida—Resistente al Maltrato de  
Aerador—Sin Hoyo para la Barra de Alzar

**RP20666**  
Spout Assembly—1/2 GPM—Vandal Resistant  
Aerador—No Lift Rod Hole  
Ensamble de la Salida—1/2 GPM—Resistente al  
Maltrato de Aerador—Sin Hoyo para la Barra de Alzar

**RP25513**  
Stem w/Stop  
Espiga con Tope

**RP12496**  
End Valve Assembly—WF (IPS Adapter)  
Ensamble de la Válvula Final—WF (Adaptador de IPS)

**RP6060**  
Bonnet Nuts  
Bonetes/Capuchones

**RP24097**  
1/4 Turn Stop for RP24096  
(Optional)  
Tope a un 1/4 de Giración  
para RP24096 (Opcional)

**RP24096**  
Stem Unit Assembly—  
Brass Stem—SS Plate  
Ensamble de la Unidad del  
Vástago—Vástago de  
Bronce—Placa de Acero  
Inoxidable

**RP4993**  
Seats & Springs  
Asientos y Resortes

**RP10965**  
Base w/Gasket  
Base con Empaque

**RP9519**  
Nuts & Washers  
Tuercas y Arandelas

**RP11887**  
Braided Stainless Steel Hose  
Manguera Trenzada de Acero  
Inoxidable

IPS Adapters—  
WF Models Only  
Adaptadores de IPS—  
Soló Modelos WF

**RP5861**  
Coupling Nuts—  
WF Models Only  
Tuercas de Acoplamiento—  
Soló Modelos WF

Inlet Tubes  
Install Away  
from Spout  
Los Tubos de  
Entrada se  
Instalan en  
Sentido  
Opuesto del  
Pico del Tubo

**RP6420**  
Wrench  
Llave

**RP17741**  
Base w/Gasket  
Base con Empaque

**RP6052**  
Gasket  
Empaque

**RP6087**  
Nut & Washer  
Tuerca y Arandela

**RP22132**  
Helpful Hand Installation Aid  
Utensilio para Asistencia en  
Instalaciones a Mano

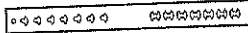

**RP10612**  
**RP11096** (Bulk Kit/Equipo de  
Cantidades Grandes)  
Thick Tile Mounting Kit  
Herramientas/Equipo para Monturas  
en Losa (Mosaico) Gruesa

**RP6379**  
Screws—Vandal Resistant  
Tornillos—Resistente al Maltrato

**RP6377**  
Button Set—Metal  
Botónes—Metal

**RP4381**  
Handle—Metal  
Manija—Metal

**RP12492**  
Screws—Vandal Resistant  
Tornillos—Resistente al Maltrato

**RP22200**  
Handle Bands (Red/Blue)  
Anillos de Manijas (Rojo/Azul)

**RP11768HDF**  
Handles w/Screws & Bands—Brass  
Manijas con Tornillos y Anillos—Bronce

**RP12490**  
Screws—Vandal Resistant  
(Red/Blue)  
Tornillos—Resistente al Maltrato  
(Rojo/Azul)

**RP12491**  
Handles w/Screws (Red/Blue)  
Manijas con Tornillos (Rojo/Azul)

## OPTIONAL/OPCIONAL

**RP8230**  
Ceramic Stem Unit, Seat, O-Ring, Spring & Screw  
Unidad del Vástago de Cerámica, Asiento, Anillo "O",  
Resorte y Tornillo

**RP10700**  
Ceramic Seats, O-Rings & Springs  
Asientos de Cerámica, Anillos "O" y Resortes

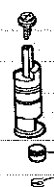
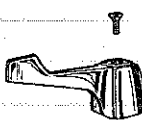

# Models / Modelos 3541-HDF, 3545-HDF, 3548-HDF, 3549-HDF & 3551-HDF Series

**RP5202**  
Spray Outlet w/Wrench—1/2 GPM—  
Vandal Resistant  
Boca de Salida del Rociador con  
Llave—1/2 GPM—  
Resistente al Maltrato

**RP246**  
Aerator w/Wrench—Vandal Resistant  
Aireador con Llave—Resistente  
al Maltrato

**RP20667**  
Spout Assembly—Vandal Resistant Aerator—w/Lift Rod Hole  
Ensamble del Tubo de Salida—Resistente al Maltrato de  
Aireador—con Hueco para la Barra de Alzar

**RP20668**  
Spout Assembly—Vandal Resistant Aerator—No Lift Rod Hole  
Ensamble del Tubo de Salida—Resistente al Maltrato de  
Aireador—Sin Hueco para la Barra de Alzar

**RP20669**  
Spout Assembly—1/2 GPM—Vandal Resistant Aerator—  
No Lift Rod Hole  
Ensamble del Tubo de Salida—1/2 GPM—Resistente al  
Maltrato de Aireador—Sin Hueco para la Barra de Alzar

**RP12496**  
End Valve Assembly—WF (IPS Adapter)  
Ensamble de la Válvula Final—WF (Adaptador de IPS)

Inlet Tubes  
Install Away  
from Spout  
Los Tubos de  
Entrada se  
Instalan en  
Sentido  
Opuesto del  
Pico del Tubo

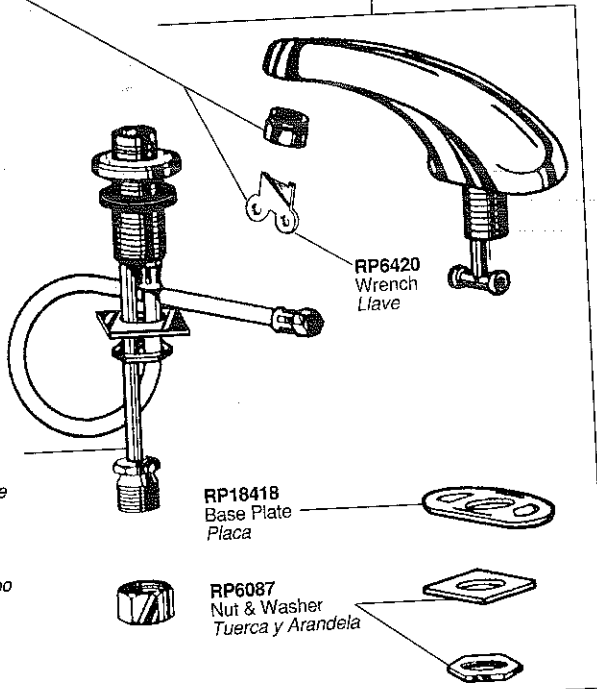

**RP6420**  
Wrench  
Llave

**RP18418**  
Base Plate  
Placa

**RP6087**  
Nut & Washer  
Tuerca y Arandela

**RP10612**  
**RP11096** (Bulk Kit/Equipo de  
Cantidades Grandes)  
Thick Tile Mounting Kit  
Herramientas/Equipo para Monturas  
en Losa (Mosaico) Gruesa

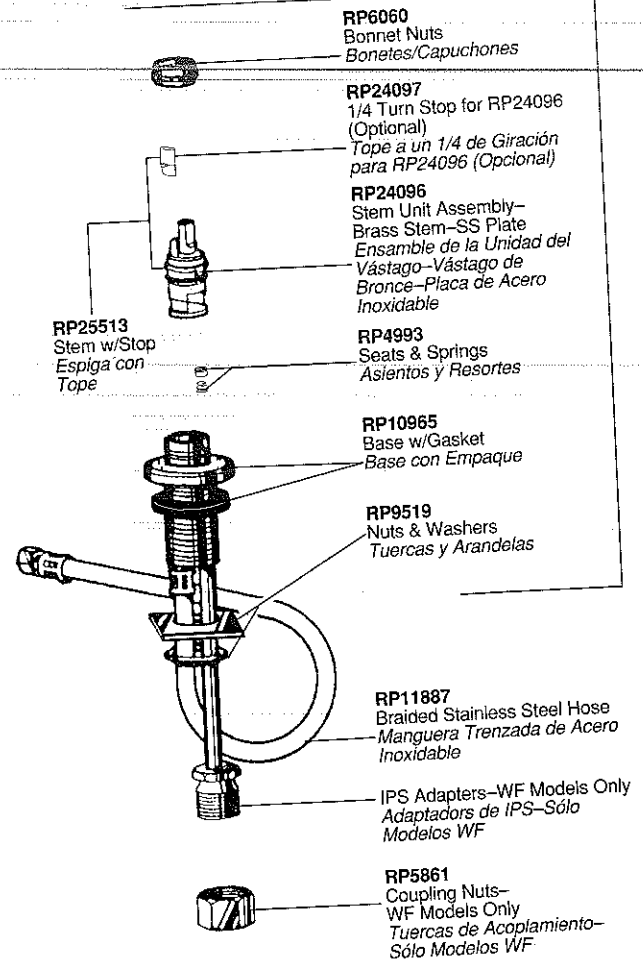

**RP6060**  
Bonnet Nuts  
Bonetes/Capuchones

**RP24097**  
1/4 Turn Stop for RP24096  
(Optional)  
Tope a un 1/4 de Giración  
para RP24096 (Opcional)

**RP24096**  
Stem Unit Assembly—  
Brass Stem—SS Plate  
Ensamble de la Unidad del  
Vástago—Vástago de  
Bronce—Placa de Acero  
Inoxidable

**RP25513**  
Stem w/Stop  
Espiga con  
Tope

**RP4993**  
Seats & Springs  
Asientos y Resortes

**RP10965**  
Base w/Gasket  
Base con Empaque

**RP9519**  
Nuts & Washers  
Tuercas y Arandelas

**RP11887**  
Braided Stainless Steel Hose  
Manguera Trenzada de Acero  
Inoxidable

IPS Adapters—WF Models Only  
Adaptadores de IPS—Solo  
Modelos WF

**RP5861**  
Coupling Nuts—  
WF Models Only  
Tuercas de Acoplamiento—  
Solo Modelos WF

Refer to pages 44 & 45 for lavatory drain assemblies. Para ensamble de drenaje para lavamanos refiérase a la páginas 44 y 45.

**33T290** (w/overflow holes/con  
huecos para desbordes)  
**33T290-1** (no overflow holes/sin  
huecos para desbordes)  
Offset Grid Strainer Assembly  
Ensamble del Colador Acabado  
con Rejilla

CAMBRIDGE  
BRASS USA

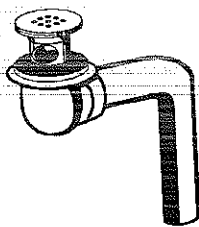

**RP5651**  
Pop-Up Assembly  
Ensamble del Desagüe Automático

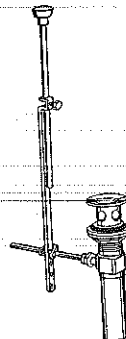

**RP6346**  
Grid Strainer Assembly  
Ensamble del Colador con Rejilla

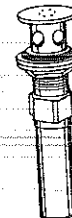

# Two Handle Lavatory Faucets Llave de Dos Manijas (Manerales) para Lavamanos

Models/Modelos 3504, 3523 & 3524 Series

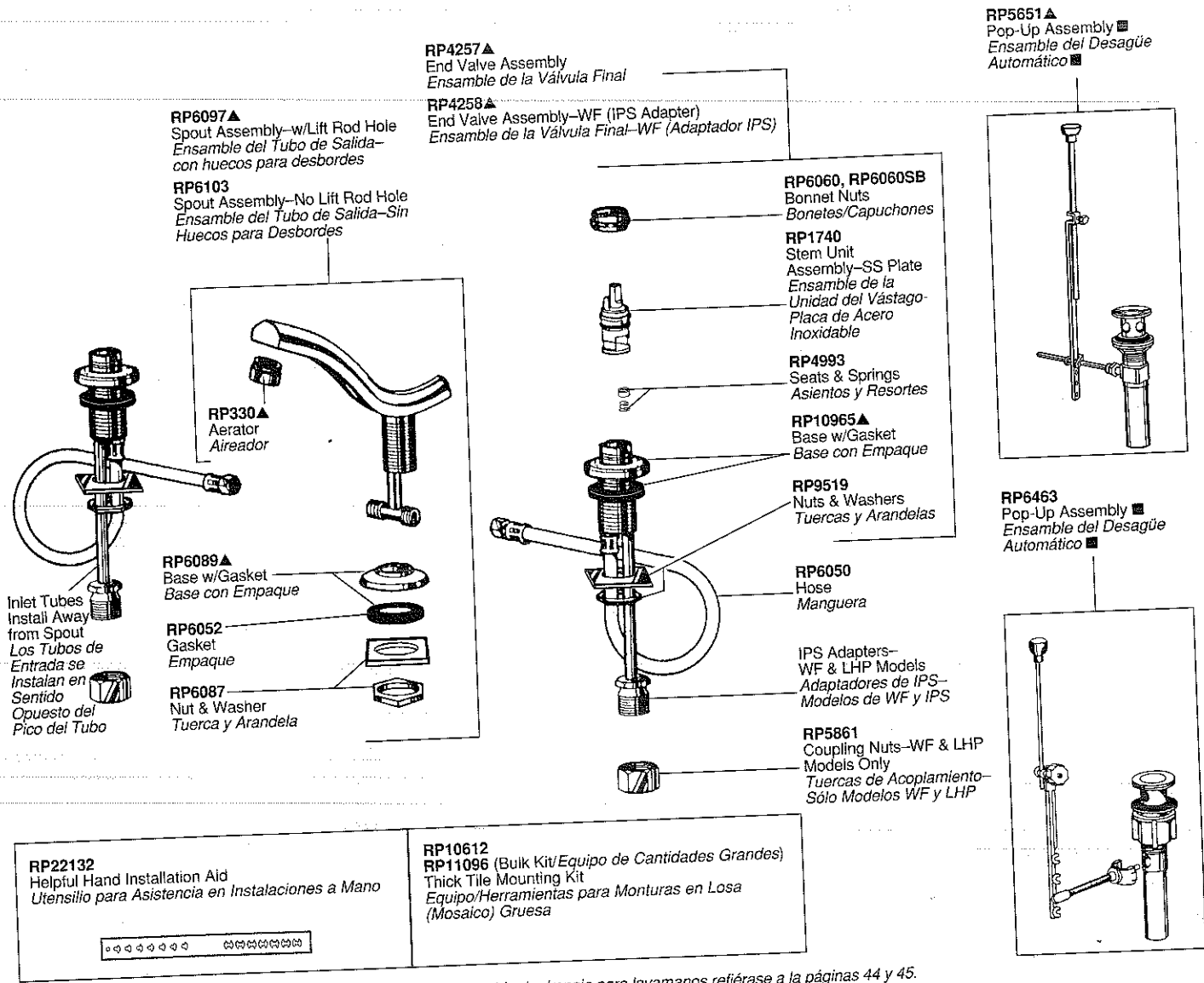

Refer to pages 44 & 45 for lavatory drain assemblies. Para ensamble de drenaje para lavamanos refiérase a la páginas 44 y 45.

**H41, H41PB**  
Medium Knob Handles w/Buttons & Screws  
Manijas de Perilla Mediana con Botones y Tornillos

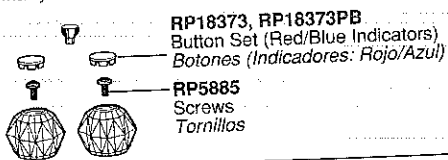

**H48**  
Metal Knob Handles w/Buttons & Screws  
Manijas de Perilla Metal con Botones y Tornillos

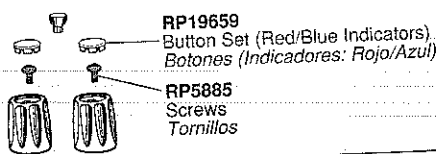

**H27, H27PB**  
Small Porcelain Cross-Handles w/Screws  
Manijas de Cruz Pequeño de Porcelana con Tornillos

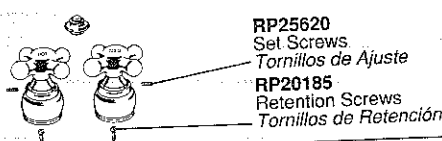

**H21, H21PB**  
Small Knob Handles w/Buttons & Screws  
Manijas de Perilla Pequeña con Botones y Tornillos

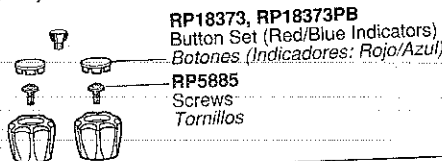

**H26, H26AC, H26AP, H26CB, H26PB, H26WC, H26WP**  
Small Metal Cross Handles w/Screws  
Manijas de Cruz de Metal Pequeño con Tornillos

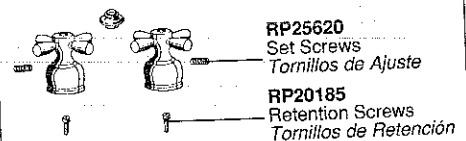

**H28**  
Blade Handles w/Buttons & Screws  
Manijas de Palanca con Botones y Tornillos

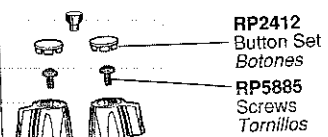

▲ Designate proper finish suffix. Verify available finishes in Miscellaneous Parts Section. **Note:** Chrome models have no finish suffix. AB=Antique Brass, AL=Almond, CB=Chrome/Polished Brass, PB=Polished Brass, SB=Satin Brass, WC=White/Chrome, WH=White, WP=White/Polished Brass.

▲ *Designe el sufijo apropiado para el acabado. Verifique acabados disponibles en la sección de Piezas Misceláneas. Nota: El acabado de los modelos de cromo no tienen sufijo. AB=Bronce Antiguo, AL=Almendra, CB=Cromo/Bronce Pulido, PB=Bronce Pulido, SB=Bronce Satinado, WC=Blanco/Cromo, WH=Blanco, WP=Blanco/Bronce Pulido.*

## Models / Modelos 3543, 3544 & 3545 Series

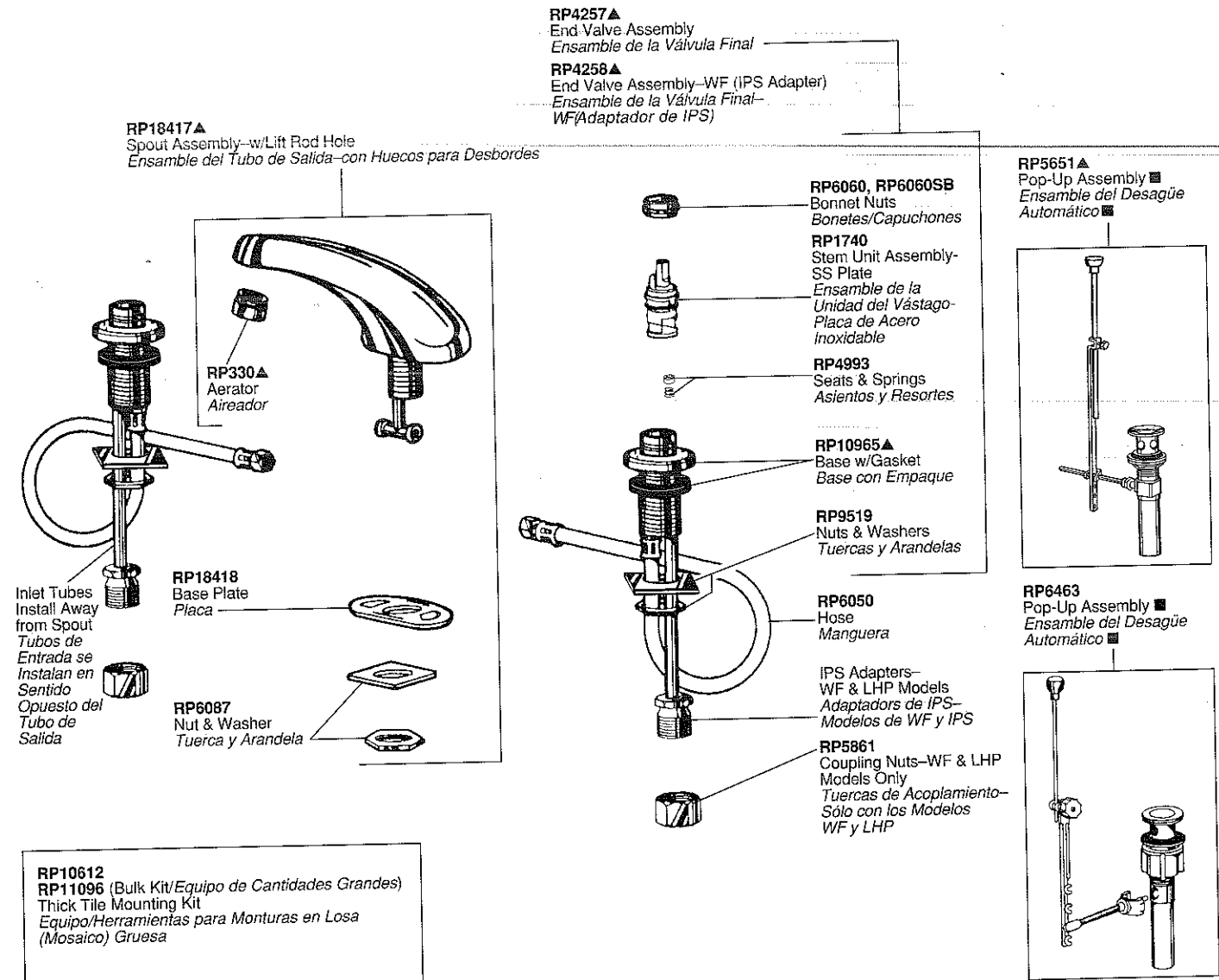

■ Refer to pages 44 & 45 for lavatory drain assemblies. *Para ensamble de drenaje para lavamanos refiérase a la páginas 44 y 45.*

**H22, H22AB, H22AL, H22PB, H22WH**  
Small Lever Handles w/Screws  
Manijas Pequeña de Palanca con Tornillos



**A22, A22AB, A22AL, A22CL, A22OK, A22PB, A22PR, A22RS, A22WH, A22WW**  
Handle Accents w/Finial  
Acces. Manijas/Botón/Barra del Desagüe

**H25, H25AC, H25AP, H25CA, H25CB, H25CW, H25CK, H25PA, H25PB, H25PK, H25PW, H25WC, H25WP**  
Small Lever Handles w/Screws  
Manijas de Pequeña de Palanca con Tornillos

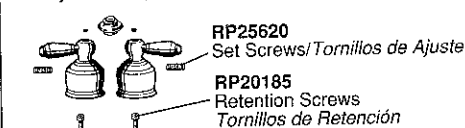

**H24, H24AL, H24PB, H24WH**  
Small Lever Handles w/Screws  
Manijas Pequeña de Palanca con Tornillos



**A24, A24AL, A24CL, A24PB, A24WH**  
Handle Accents w/Finial  
Acces. Manijas/Botón/Barra Desagüe

**RP12490**  
Screws-Vandal Resistant (Red/Blue)  
Tornillos-Resistente al Maltrato (Rojo/Azul)

**RP12491**  
Wrist Blade Handles w/Screws (Red/Blue)  
Manijas Tipo Aleta con Tornillos (Rojo/Azul)

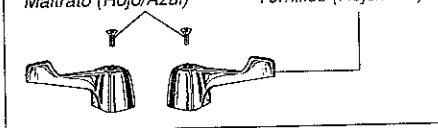

**H23, H23AB, H23AL, H23PB, H23WH**  
Small Ring Handles w/Caps & Screws  
Manijas de Anillo Pequeña con Casquetes y Tornillos

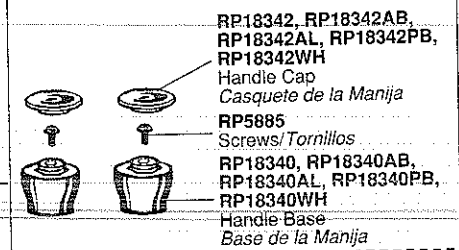

**A23, A23AB, A23AL, A23OK, A23PB, A23ST, A23STAB, A23STAL, A23STPB, A23STWH**  
Handle Accents w/Finial  
Accesorios de Manijas con Botón para la Barra del Desagüe

# Two Handle Lavatory Faucets Llave de Dos Manijas (Manerales) para Lavamanos

Model/Modelo 3567 Series

**RP15546▲**  
Spout Assembly-w/Lift Rod Hole  
Ensamble del Tubo de Salida-  
con Huecos para Desbordes

**RP18454  
RP18454PB**  
Aerator  
Aireador

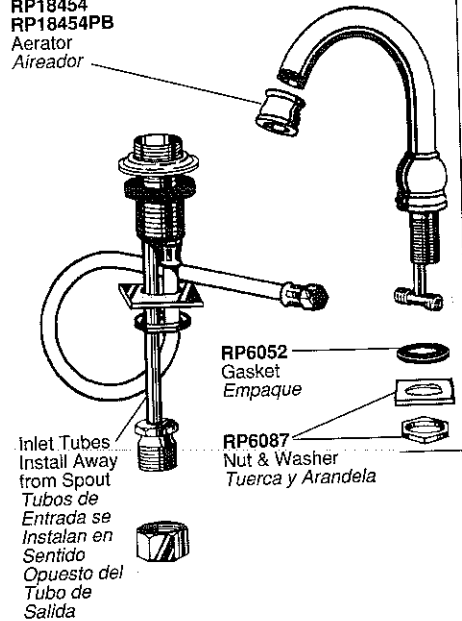

**RP6052**  
Gasket  
Empaque

**RP6087**  
Nut & Washer  
Tuerca y Arandela

**RP23096  
RP23096PB**  
End Valve Assembly-WF (IPS Adapter)  
Ensamble de la Válvula Final-WF (Adaptador de IPS)

**RP6060, RP6060SB**  
Bonnet Nuts  
Bonetes/Capuchones

**RP1740**  
Stem Unit Assembly-  
SS Plate  
Ensamble de la  
Unidad del Vástago-  
Placa de Acero Inoxidable

**RP4993**  
Seats & Springs  
Asientos y Resortes

**RP23095▲**  
Base w/Gasket  
Base con Empaque

**RP9519**  
Nuts & Washers  
Tuercas y Arandelas

**RP6050**  
Hose  
Manguera

IPS Adapters  
Adaptadores de IPS

**RP5861**  
Coupling Nuts  
Tuercas de Acoplamiento

**RP15551▲**  
Lift Rod/Barra de Alzar  
**RP26533▲**  
Pop-Up Assy. Less Lift Rod  
Ensamble de Desagüe Automático  
sin Barra de Alzar

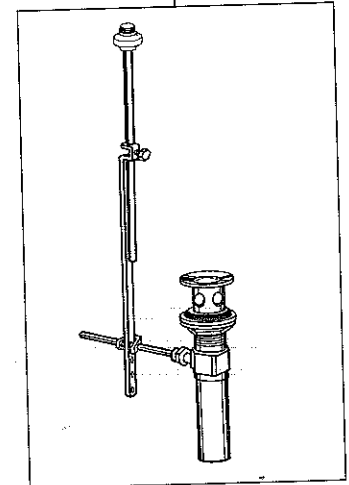

**RP22132**  
Helpful Hand installation Aid  
Utensilio para Asistencia en Instalaciones a Mano



**RP10612  
RP11096 (Bulk Kit/Equipo de Cantidades Grandes)**  
Thick Tile Mounting Kit  
Equipo/Herramientas para Monturas en Losa  
(Mosaico) Gruesa

Refer to pages 44 & 45 for lavatory drain assemblies. Para ensambles de drenaje para lavamanos refiérase a la página 44 & 45.

<p><b>H41, H41PB</b> Medium Knob Handles w/Buttons &amp; Screws Manijas de Perilla Mediana con Botones y Tornillos</p> <p><b>RP18373, RP18373PB</b> Button Set (Red/Blue Indicators) Botones (Indicadores: Rojo/Azul)</p> <p><b>RP5885</b> Screws Tornillos</p>	<p><b>H27, H27PB</b> Small Porcelain Cross Handles w/Screws Manijas de Cruz Pequeña de Porcelana con Tornillos</p> <p><b>RP25620</b> Set Screws Tornillos de Ajuste</p> <p><b>RP20185</b> Retention Screws Tornillos de Retención</p>	<p><b>H26, H26AC, H26AP, H26CB, H26PB, H26WC, H26WP</b> Small Metal Cross Handles w/Screws Manijas de Cruz de Metal Pequeño con Tornillos</p> <p><b>RP25620</b> Set Screws Tornillos de Ajuste</p> <p><b>RP20185</b> Retention Screws Tornillos de Retención</p>
<p><b>H48</b> Metal Knob Handles w/Buttons &amp; Screws Manijas de Perilla Metal con Botones y Tornillos</p> <p><b>RP19659</b> Button Set (Red/Blue Indicators) Botones (Indicadores: Rojo/Azul)</p> <p><b>RP5885</b> Screws Tornillos</p>	<p><b>H21, H21PB</b> Small Knob Handles w/Buttons &amp; Screws Manijas de Perilla Pequeña con Botones y Tornillos</p> <p><b>RP18373, RP18373PB</b> Button Set (Red/Blue Indicators) Botones (Indicadores: Rojo/Azul)</p> <p><b>RP5885</b> Screws Tornillos</p>	<p><b>H28</b> Blade Handles w/Buttons &amp; Screws Manijas de Palanca con Botones y Tornillos</p> <p><b>RP2412</b> Button Set Botones</p> <p><b>RP5885</b> Screws Tornillos</p>

See Page 19 for Handle Suffix Chart/Vea la table en página 19 para más detalles sobre sufixos de manijas

▲ Designate proper finish suffix. Verify available finishes in Miscellaneous Parts Section. **Note:** Chrome models have no finish suffix. AC=Almond/Chrome, AL=Almond, AP=Almond/Polished Brass, CB=Chrome/Polished Brass, PB=Polished Brass, WC=White/Chrome, WH=White, WP=White/Polished Brass.

▲ *Designe el sufijo apropiado para el acabado. Verifique acabados disponibles en la sección de Piezas Misceláneas.* **Nota:** El acabado de los modelos de cromo no tienen sufijo. AC=Almendra/Cromo, AL=Almendra, AP=Almendra/Bronce Pulido, CB=Cromo/Bronce Pulido, PB=Bronce Pulido, WC=Blanco/Cromo, WH=Blanco, WP=Blanco/Bronce Pulido.

# Model / Modelo 3576\* Series

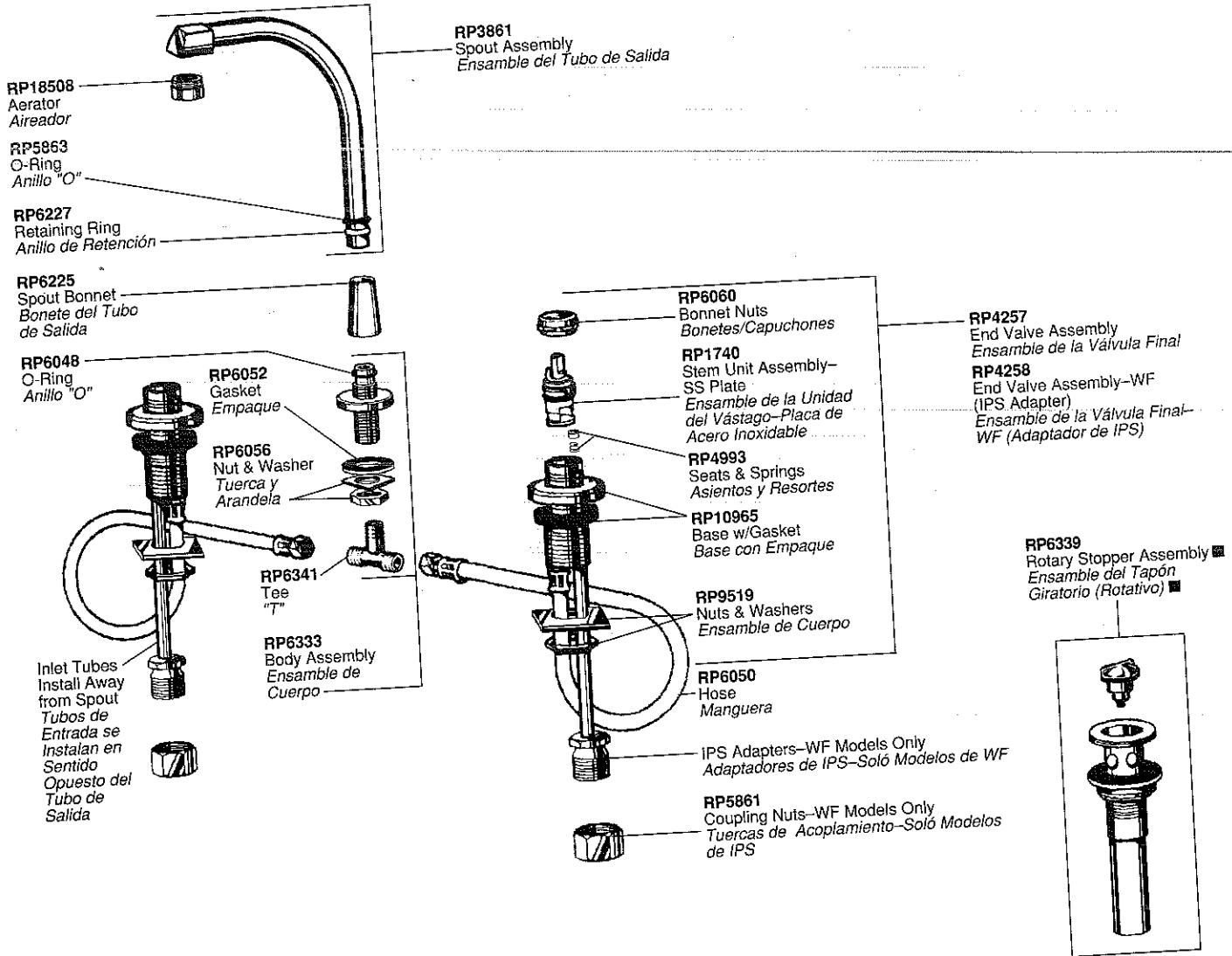

\*Discontinued/Descontinuados

■ Refer to pages 44 & 45 for lavatory drain assemblies. Para ensambles de drenaje para lavamanos refírase a la página 44 & 45.

**H22, H22AB, H22AL, H22PB, H22WH**  
 Small Lever Handles w/Screws  
 Manijas Pequeña de Palanca con Tornillos

**RP25620** Set Screws/Tornillos de Ajuste  
**RP20185** Retention Screws / Tornillos de Retención

**A22, A22AB, A22AL, A22CL, A22OK, A22PB, A22PR, A22RS, A22WH, A22WW**  
 Handle Accents w/Finial  
 Acces. Manijas/Botón/Barra del Desaghe

**H24, H24AL, H24PB, H24WH**  
 Small Lever Handles w/Screws  
 Manijas Pequeña de Palanca con Tornillos

**RP25620** Set Screws/Tornillos de Ajuste  
**RP20185** Retention Screws / Tornillos de Retención

**A24, A24AL, A24CL, A24PB, A24WH**  
 Handle Accents w/Finial  
 Acces. Manijas/Botón/Barra Desaghe

**H23, H23AB, H23AL, H23PB, H23WH**  
 Small Ring Handles w/Caps & Screws  
 Manijas de Anillo Pequeña con Casquetes y Tornillos

**RP18342, RP18342AB, RP18342AL, RP18342PB, RP18342WH**  
 Handle Cap / Casquete de la Manija  
**RP5885** Screws/Tornillos  
**RP18340, RP18340AB, RP18340AL, RP18340PB, RP18340WH**  
 Handle Base / Base de la Manija

**H25, H25AC, H25AP, H25CA, H25CB, H25CW, H25CK, H25PA, H25PB, H25PW, H25WC, H25WP**  
 Small Lever Handles w/Screws  
 Manijas de Pequeña de Palanca con Tornillos

**RP25620** Set Screws/Tornillos de Ajuste  
**RP20185** Retention Screws / Tornillos de Retención

**RP12490** Screws-Vandal Resistant (Red/Blue) / Tornillos-Resistente al Maltrato (Rojo/Azul)  
**RP12491** Wrist Blade Handles w/Screws (Red/Blue) / Manija Tipo Aleta con Tornillos (Rojo/Azul)

**A23, A23AB, A23AL, A23OK, A23PB, A23ST, A23STAB, A23STAL, A23STPB, A23STWH, A23WH**  
 Handle Accents w/Finial  
 Accesorios de Manijas con Botón para la Barra del Desaghe

See Page 19 for Handle Suffix Chart/ Vea la table en página 19 para más detalles sobre sufijos de manijas



# Two Handle Lavatory Faucets Llave de Dos Manijas (Manerales) para Lavamanos

Model/Modelo 3577 Series

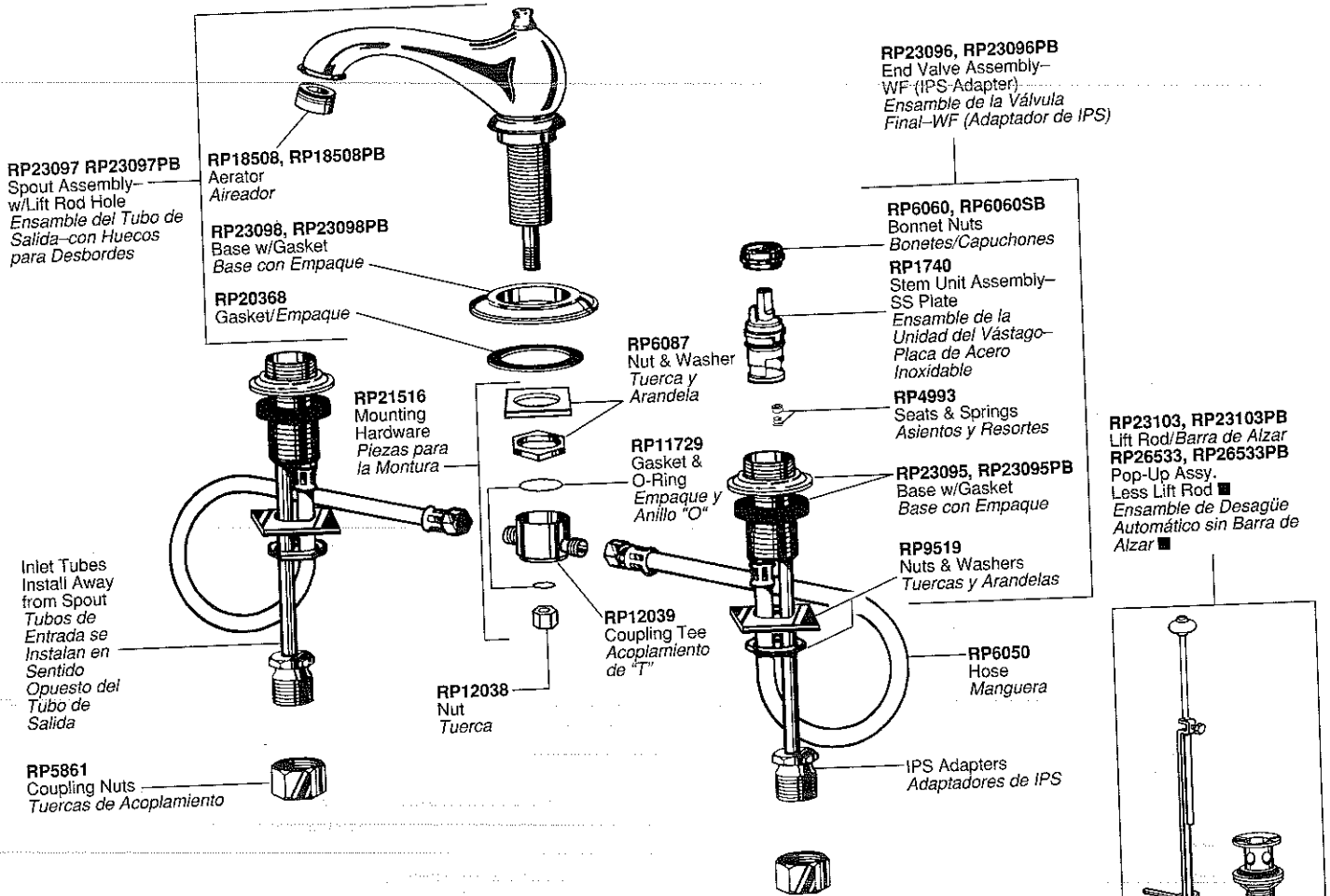

**RP22132**  
Helpful Hand Installation Aid  
Utensilio para Asistencia en Instalaciones a Mano

**RP10612**  
**RP11096** (Bulk Kit/Equipo de Cantidades Grandes)  
Thick Tile Mounting Kit for End Valves  
Equipo/Herramientas para Monturas en Losa (Mosaico) Gruesa para las Válvulas Final

Refer to pages 44 & 45 for lavatory drain assemblies. Para ensambles de drenaje para lavamanos refiérase a la página 44 y 45.

<p><b>H41, H41PB</b> Medium Knob Handles w/Buttons &amp; Screws Manijas de Perilla Mediana con Botones y Tornillos</p> <p><b>RP18373, RP18373PB</b> Button Set (Red/Blue Indicators) Botones (Indicadores: Rojo/Azul)</p> <p><b>RP5885</b> Screws Tornillos</p>	<p><b>H27, H27PB</b> Small Porcelain Cross Handles w/Screws Manijas de Cruz Pequeño de Porcelana con Tornillos</p> <p><b>RP25620</b> Set Screws Tornillos de Ajuste</p> <p><b>RP20185</b> Retention Screws Tornillos de Retención</p>	<p><b>H26, H26AC, H26AP, H26CB, H26PB, H26WC, H26WP</b> Small Metal Cross Handles w/Screws Manijas de Cruz de Metal Pequeño con Tornillos</p> <p><b>RP25620</b> Set Screws Tornillos de Ajuste</p> <p><b>RP20185</b> Retention Screws Tornillos de Retención</p>
<p><b>H48</b> Metal Knob Handles w/Buttons &amp; Screws Manijas de Perilla Metal con Botones y Tornillos</p> <p><b>RP19659</b> Button Set (Red/Blue Indicators) Botones (Indicadores: Rojo/Azul)</p> <p><b>RP5885</b> Screws Tornillos</p>	<p><b>H21, H21PB</b> Small Knob Handles w/Buttons &amp; Screws Manijas de Perilla Pequeña con Botones y Tornillos</p> <p><b>RP18373, RP18373PB</b> Button Set (Red/Blue Indicators) Botones (Indicadores: Rojo/Azul)</p> <p><b>RP5885</b> Screws Tornillos</p>	<p><b>H28</b> Blade Handles w/Buttons &amp; Screws Manijas de Palanca con Botones y Tornillos</p> <p><b>RP2412</b> Button Set Botones</p> <p><b>RP5885</b> Screws Tornillos</p>

See Page 19 for Handle Suffix Chart/Vea la tabla en página 19 para más detalles sobre sufijos de manijas

▲ Designate proper finish suffix. Verify available finishes in Miscellaneous Parts Section. **Note:** Chrome models have no finish suffix. AL=Almond, CB=Chrome/Polished Brass, CP=Polished Brass/Chrome, PB=Polished Brass, WC=White/Chrome, WH=White, WP=White/Polished Brass.

▲ *Designe el sufijo apropiado para el acabado. Verifique acabados disponibles en la sección de Piezas Misceláneas. Nota: El acabado de los modelos de cromo no tienen sufijo. AB=Bronce Antiguo, AL=Almendra, CB=Cromo/Bronce Pulido, CP=Cromo/Bronce Pulido, WC=Blanco/Cromo, WH=Blanco, WP=Blanco/Polished Brass.*

# Models/Modelos 3583 & 3584 Series

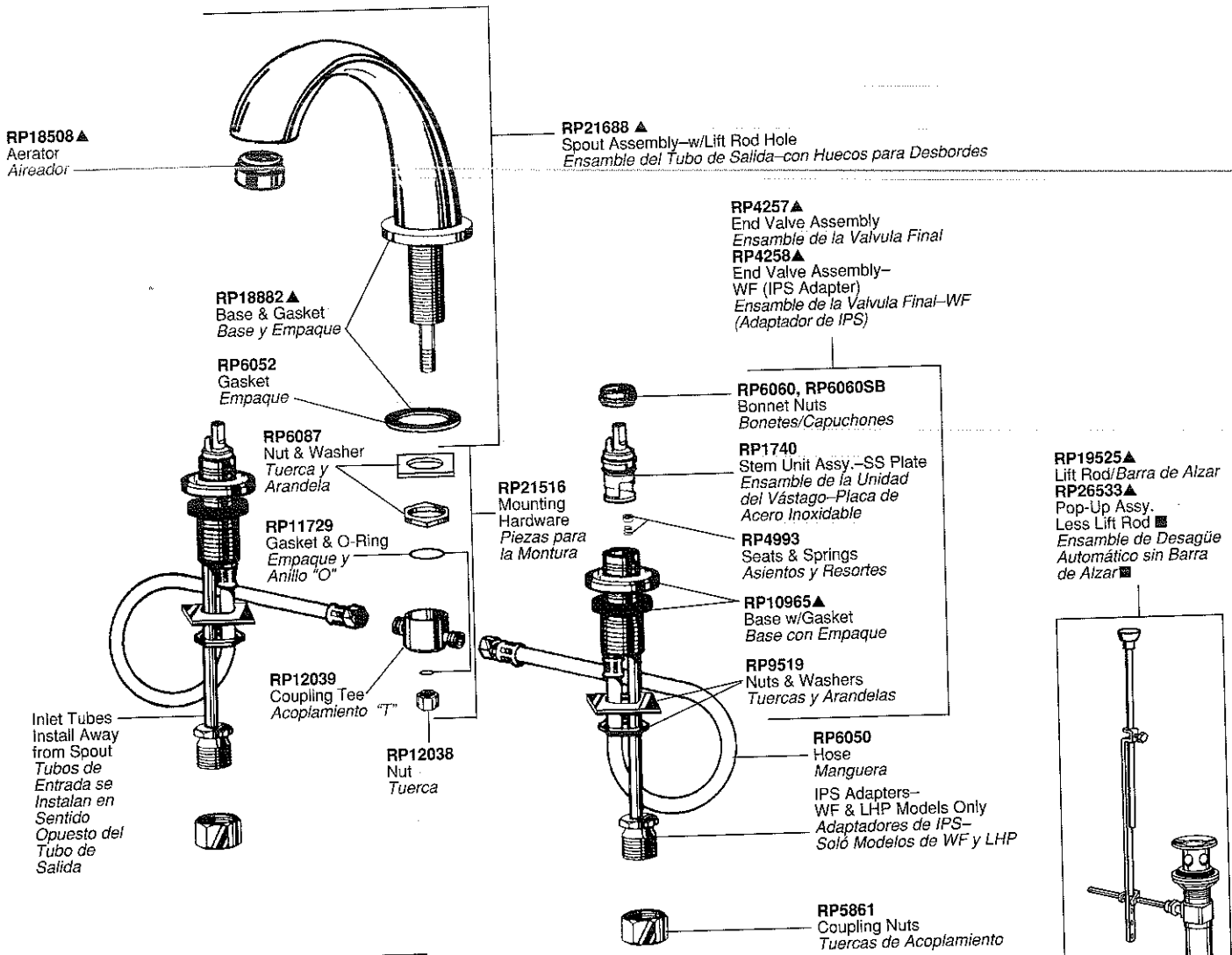

■ Refer to pages 44 & 45 for lavatory drain assemblies. *Para ensamblajes de drenaje para lavamanos refiérase a la página 44 y 45.*

**H22, H22AB, H22AL, H22PB, H22WH**  
Small Lever Handles w/Screws  
Manijas Pequeña de Palanca con Tornillos

**RP25620**  
Set Screws/Tornillos de Ajuste

**RP20185**  
Retention Screws  
Tornillos de Retención

**A22, A22AB, A22AL, A22CL, A22OK, A22PB, A22PR, A22RS, A22WH, A22WW**  
Handle Accents w/Finial  
Acces. Manijas/Botón/Barra Desagüe

**H24, H24AL, H24PB, H24WH**  
Small Lever Handles w/Screws  
Manijas Pequeña de Palanca con Tornillos

**RP25620**  
Set Screws/Tornillos de Ajuste

**RP20185**  
Retention Screws  
Tornillos de Retención

**A24, A24AL, A24CL, A24PB, A24WH**  
Handle Accents w/Finial  
Acces. Manijas/Botón/Barra Desagüe

**H23, H23AB, H23AL, H23PB, H23WH**  
Small Ring Handles w/Caps & Screws  
Manijas de Anillo Pequeña con Casquetes y Tornillos

**RP18342, RP18342AB, RP18342AL, RP18342PB, RP18342WH**  
Handle Cap  
Casquete de la Manija

**RP5885**  
Screws/Tornillos

**RP18340, RP18340AB, RP18340AL, RP18340PB, RP18340WH**  
Handle Base  
Base de la Manija

**H25, H25AC, H25AP, H25CA, H25CB, H25CW, H25CK, H25PA, H25PB, H25PK, H25PW, H25WC, H25WP**  
Small Lever Handles w/Screws  
Manijas de Pequeña de Palanca con Tornillos

**RP25620**  
Set Screws/Tornillos de Ajuste

**RP20185**  
Retention Screws  
Tornillos de Retención

**RP12490**  
Screws-Vandal Resistant (Red/Blue)  
Tornillos-Resistente al Maltrato (Rojo/Azul)

**RP12491**  
Wrist Blade Handles w/Screws (Red/Blue)  
Manijas de Tipo Aleta con Tornillos (Rojo/Azul)

**A23, A23AB, A23AL, A23OK, A23PB, A23ST, A23STAB, A23STAL, A23STPB, A23STWH, A23WH**  
Handle Accents w/Finial  
Accesorios de Manijas con Botón para la Barra del Desagüe

See Page 19 for Handle Suffix Chart/Vea la tabla en página 19 para más detalles sobre sufijos de manijas

# Two Handle Lavatory Faucets

## Llave de Dos Manijas (Manerales) para Lavamanos

Model/Modelo 3530 Series

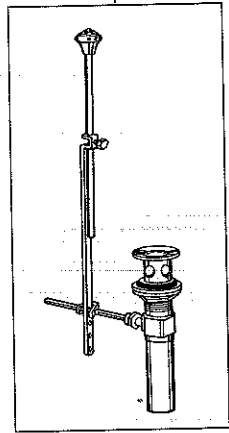
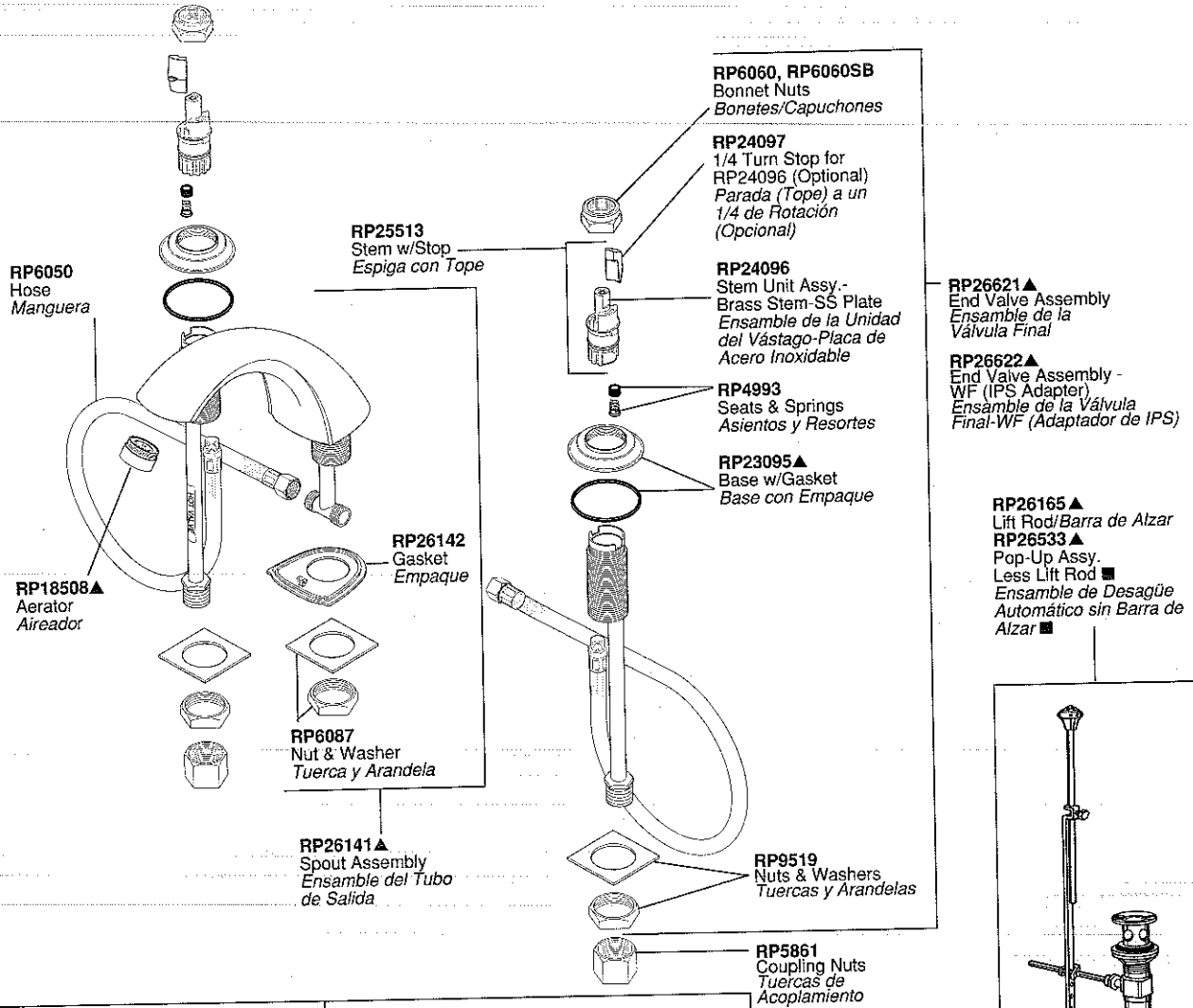

**RP22132**  
Helpful Hand Installation Aid  
Utensilio para Asistencia en Instalaciones a Mano

**RP10612**  
**RP11096** (Bulk Kit/Equipo de Cantidades Grandes)  
Thick Tile Mounting Kit  
Equipo para Monturas en Losa Gruesa

Refer to pages 44 & 45 for lavatory drain assemblies. Para ensambles de drenaje para lavamanos refiérase a la página 44 y 45.

<p><b>H41, H41PB</b> Medium Knob Handles w/Buttons &amp; Screws Manijas de Perilla Mediana con Botones y Tornillos</p> <p><b>RP18373, RP18373PB</b> Button Set (Red/Blue Indicators) Botones (Indicadores: Rojo/Azul)</p> <p><b>RP5885</b> Screws Tornillos</p>	<p><b>H27, H27PB</b> Small Porcelain Cross Handles w/Screws Manijas de Cruz Pequeño de Porcelana con Tornillos</p> <p><b>RP25620</b> Set Screws Tornillos de Ajuste</p> <p><b>RP20185</b> Retention Screws Tornillos de Retención</p>	<p><b>H26, H26AC, H26AP, H26CB, H26PB, H26WC, H26WP</b> Small Metal Cross Handles w/Screws Manijas de Cruz de Metal Pequeño con Tornillos</p> <p><b>RP25620</b> Set Screws Tornillos de Ajuste</p> <p><b>RP20185</b> Retention Screws Tornillos de Retención</p>
<p><b>H48</b> Metal Knob Handles w/Buttons &amp; Screws Manijas de Perilla Metal con Botones y Tornillos</p> <p><b>RP19659</b> Button Set (Red/Blue Indicators) Botones (Indicadores: Rojo/Azul)</p> <p><b>RP5885</b> Screws Tornillos</p>	<p><b>H21, H21PB</b> Small Knob Handles w/Buttons &amp; Screws Manijas de Perilla Pequeña con Botones y Tornillos</p> <p><b>RP18373, RP18373PB</b> Button Set (Red/Blue Indicators) Botones (Indicadores: Rojo/Azul)</p> <p><b>RP5885</b> Screws Tornillos</p>	<p><b>H28</b> Blade Handles w/Buttons &amp; Screws Manijas de Palanca con Botones y Tornillos</p> <p><b>RP2412</b> Button Set Botones</p> <p><b>RP5885</b> Screws Tornillos</p>

See Page 19 for Handle Suffix Chart/Vea la tabla en página 19 para más detalles sobre sufijos de manijas

▲ Designate proper finish suffix. Verify available finishes in Miscellaneous Parts Section. **Note:** Chrome models have no finish suffix. AL=Almond, PB=Polished Brass, WH=White.

▲ Designe el sufijo apropiado para el acabado. Verifique acabados disponibles en la sección de Piezas Misceláneas. **Nota:** El acabado de los modelos de cromo no tienen sufijo. AL=Almendra, PB=Bronce Pulido, WH=Blanco.

## Model/Modelo 4530 Series

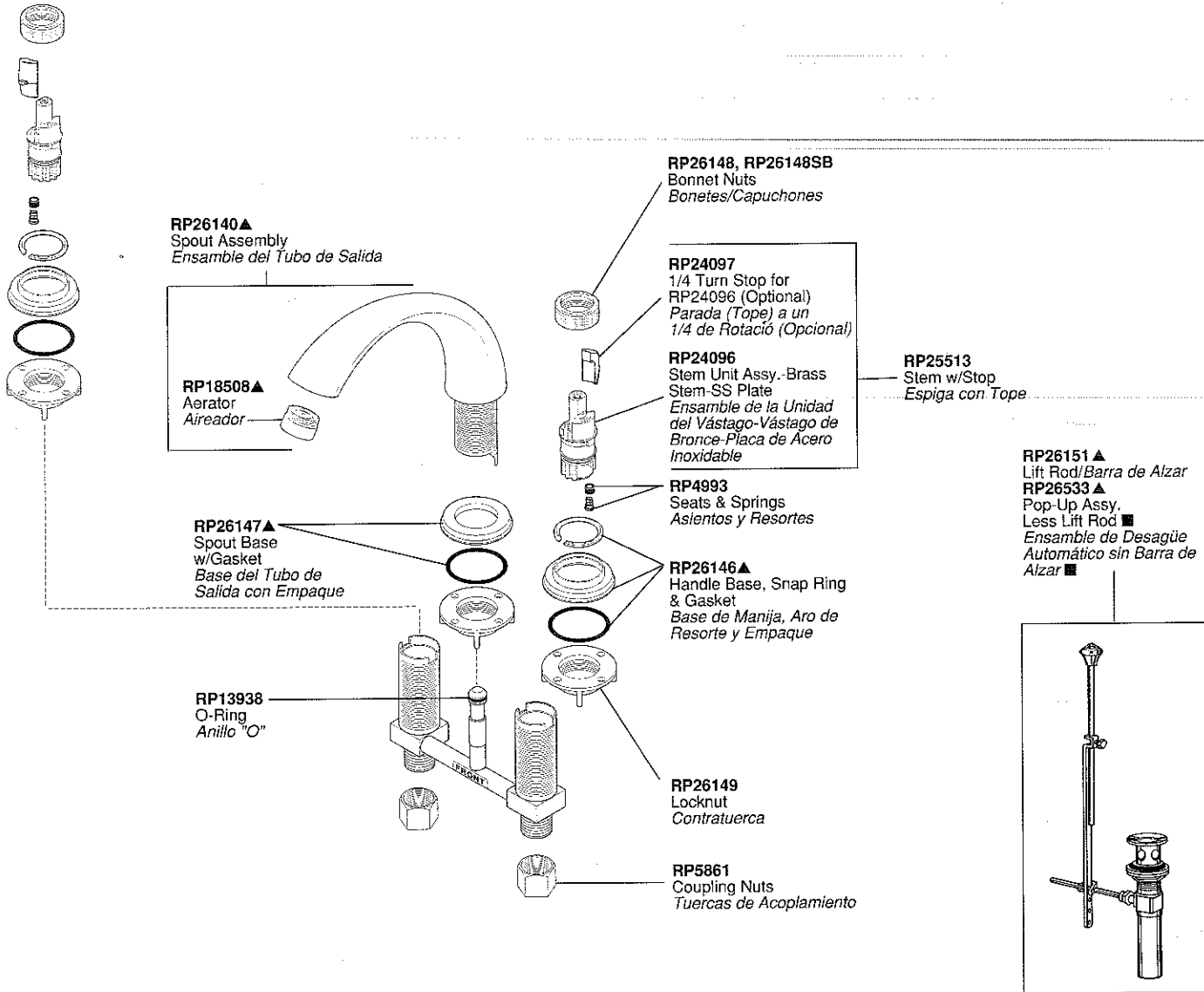

■ Refer to pages 44 & 45 for lavatory drain assemblies. Para ensambles de drenaje para lavamanos refiérase a la página 44 y 45.

**H22, H22AB, H22AL, H22PB, H22WH**  
Small Lever Handles w/Screws  
Manijas Pequeña de Palanca con Tornillos

RP25620  
Set Screws/Tornillos de Ajuste

RP20185  
Retention Screws  
Tornillos de Retención

A22, A22AB, A22AL, A22CL, A22OK,  
A22PB, A22PR, A22RS, A22WH, A22WW  
Handle Accents w/Finial  
Acces. Manijas/Botón/Barra del Desagüe

**H24, H24AL, H24PB, H24WH**  
Small Lever Handles w/Screws  
Manijas Pequeña de Palanca con Tornillos

RP25620  
Set Screws/Tornillos de Ajuste

RP20185  
Retention Screws  
Tornillos de Retención

A24, A24AL, A24CL, A24PB, A24WH  
Handle Accents w/Finial  
Acces. Manijas/Botón/Barra Desagüe

**H23, H23AB, H23AL, H23PB, H23WH**  
Small Ring Handles w/Caps & Screws  
Manijas de Anillo Pequeña con Casquetes y Tornillos

RP18342, RP18342AB,  
RP18342AL, RP18342PB,  
RP18342WH  
Handle Cap  
Casquete de la Manija

RP5885  
Screws/Tornillos

RP18340, RP18340AB,  
RP18340AL, RP18340PB,  
RP18340WH  
Handle Base  
Base de la Manija

**H25, H25AC, H25AP, H25CA, H25CB, H25CW, H25CK,  
H25PA, H25PB, H25PK, H25PW, H25WC, H25WP**  
Small Lever Handles w/Screws  
Manijas de Pequeña de Palanca con Tornillos

RP25620  
Set Screws/Tornillos de Ajuste

RP20185  
Retention Screws  
Tornillos de Retención

**RP12490**  
Screws—Vandal Resistant  
(Red/Blue)  
Tornillos—Resistente al  
Maltrato (Rojo/Azul)

**RP12491**  
Wrist Blade Handles  
w/Screws (Red/Blue)  
Manijas de Tipo Aleta  
con Tornillos (Rojo/Azul)

A23, A23AB, A23AL, A23OK,  
A23PB, A23ST, A23STAB,  
A23STAL, A23STPB,  
A23STWH, A23WH  
Handle Accents w/Finial  
Accesorios de Manijas con Botón  
para la Barra del Desagüe

See Page 19 for Handle Suffix Chart/Vea la tabla en página 19 para más detalles sobre sufijos de manijas

# Lavatory Drain Assemblies

## Ensamblajes para Desagües Automáticos para Lavamos

### Lift Rods/Barra de Alzar

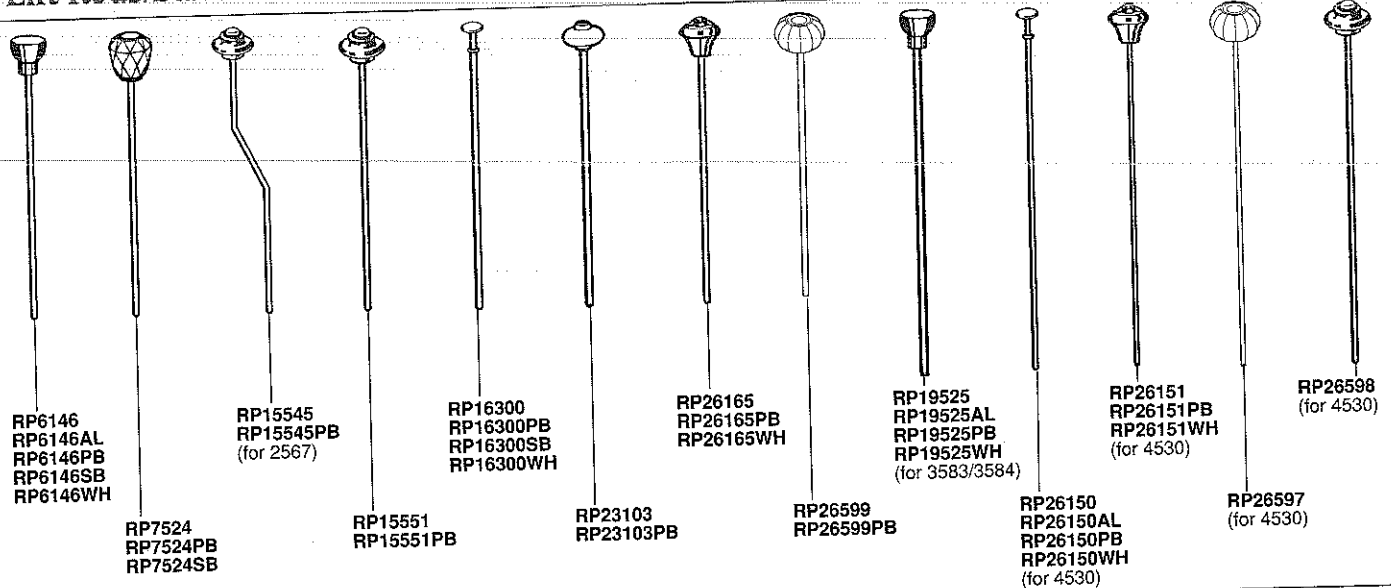

**RP5651, RP5651AB, RP5651AL, RP5651CB, RP5651PB, RP5651WH**  
**Complete Metal Pop-Up Assembly (Includes RP6146 Lift Rod)**  
*Ensamble Completo para Desagüe Automático de Metal*

**RP26533, RP26533AL, RP26533PB, RP26533WH**  
**Metal Pop-Up Assembly Less Lift Rod**  
*Ensamble de Desagüe Automático de Metal sin Barra de Alzar*

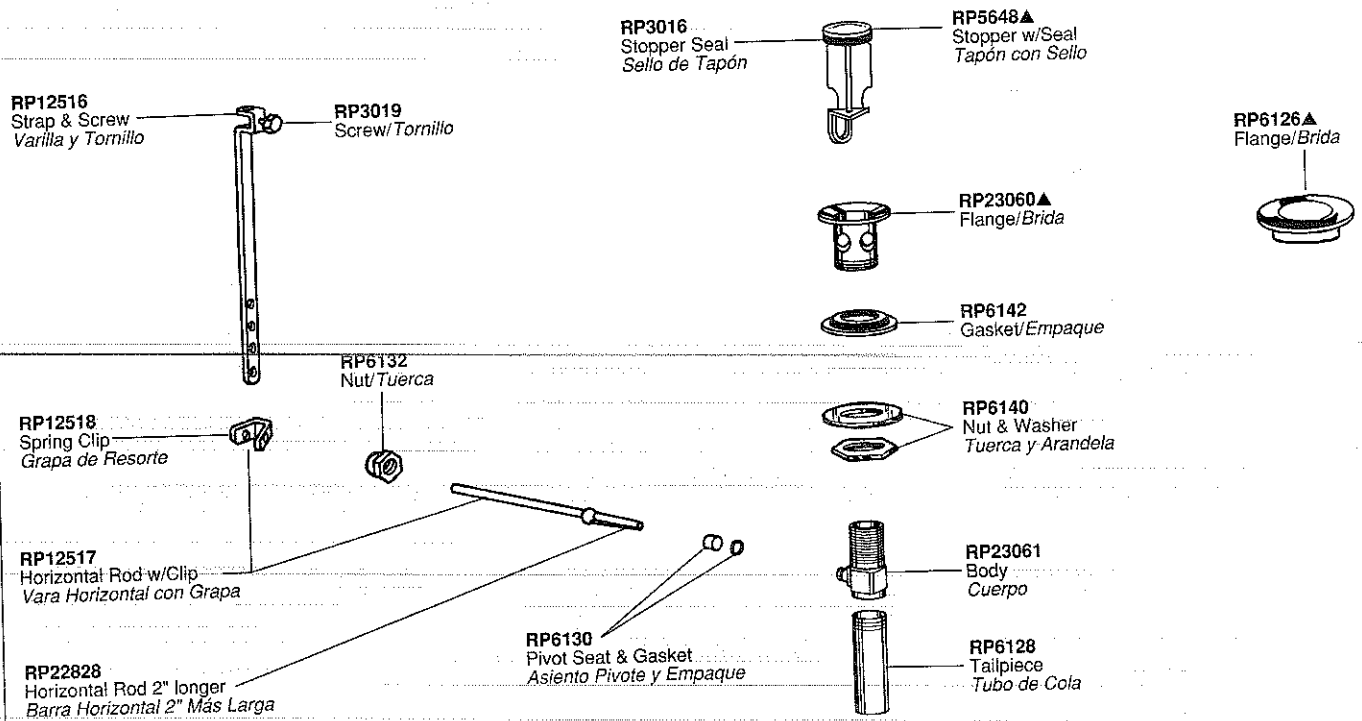

▲ Designate proper finish suffix. Verify available finishes in Miscellaneous Parts Section. **Note:** Chrome models have no finish suffix. AB=Antique Brass, AL=Almond, PB=Polished Brass, SB=Satin Brass, WH=White.

▲ *Designe el sufijo apropiado para el acabado. Verifique acabados disponibles en la sección de Piezas Misceláneas. Nota: El acabado de los modelos de cromo no tienen sufijo. AB=Bronce Antiguo, AL=Almendra, PB=Bronce Pulido, SB=Bronce Satinado, WH=Blanco.*

## RP6463-Complete Pop-up Assembly RP6463-Ensamble Completo para Desagüe Automático de Metal

RP6146  
Lift Rod  
Barra de Alzar

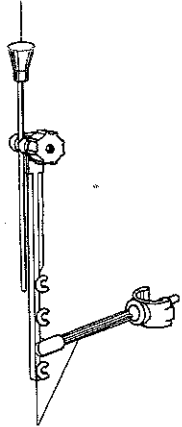

RP6477  
Pivot Rod & Strap Assembly  
Ensamble de la Barra de Pivote y Barra Chata

RP5648  
Stopper/Tapón



RP6876  
Foam Gasket  
Foliana de Goma

RP6142  
Gasket/Empaque

RP6475  
Nut/Tuerca

RP6481  
O-Ring/Anillo "O"

### Accessory Items Piezas de Accesorios

RP7585  
Extender  
Pieza de Extensión

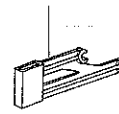

RP10994  
Spacer-for thin sinks (fits between RP6142 & RP6475)  
Separador para Fregaderos Delgados



## RP6346-Complete Grid Strainer Assembly Ensamble Completo del Colador con Rejilla

Manufactured Before June 1996  
Fabricado Antes de Junio 1996

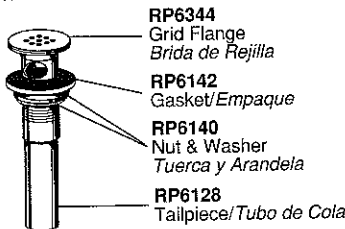

RP6344  
Grid Flange  
Brida de Rejilla

RP6142  
Gasket/Empaque

RP6140  
Nut & Washer  
Tuerca y Arandela

RP6128  
Tailpiece/Tubo de Cola

Manufactured After June 1996  
Fabricado Después de Junio 1996

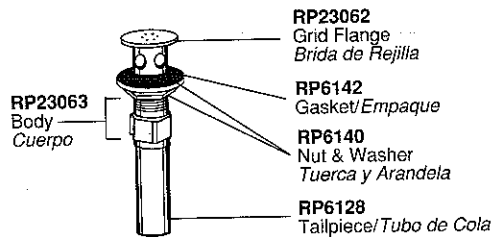

RP23062  
Grid Flange  
Brida de Rejilla

RP6142  
Gasket/Empaque

RP6140  
Nut & Washer  
Tuerca y Arandela

RP6128  
Tailpiece/Tubo de Cola

## RP6339-Complete Rotary Stopper Ensamble Completo del Tapón Giratorio

Manufactured Before June 1996  
Fabricado Antes de Junio 1996

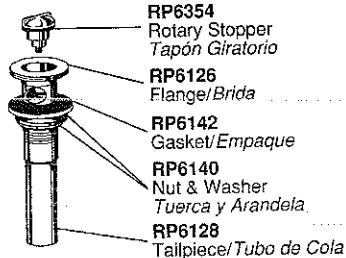

RP6354  
Rotary Stopper  
Tapón Giratorio

RP6126  
Flange/Brida

RP6142  
Gasket/Empaque

RP6140  
Nut & Washer  
Tuerca y Arandela

RP6128  
Tailpiece/Tubo de Cola

Manufactured After June 1996  
Fabricado Después de Junio 1996

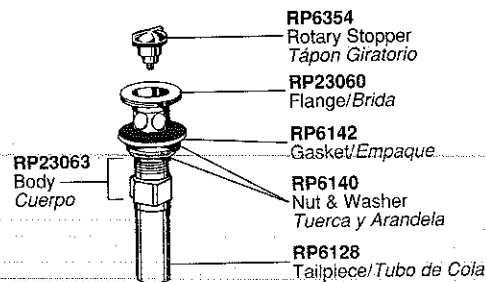

RP6354  
Rotary Stopper  
Tapón Giratorio

RP23060  
Flange/Brida

RP6142  
Gasket/Empaque

RP6140  
Nut & Washer  
Tuerca y Arandela

RP6128  
Tailpiece/Tubo de Cola

33T290 (w/overflow holes/con Huecos para Desbordes)  
33T290-1 (no overflow holes/Sin Huecos para Desbordes)  
Complete Offset Grid Strainer  
Colador Completo Acodado con Rejilla

CAMBRIDGE  
BRASS USA

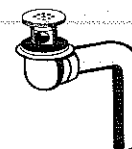

# Specialty Faucets Llaves de Especialidad

## Models/Modelos 560, 561\*, 562 & 563\* Series Shampoo Faucets/Llaves para Champú

**RP21874**  
Handle w/Set Screw-Red/Blue  
Indicators  
Manija con Tornillo de Ajuste-  
Indicadores: Rojo/Azul

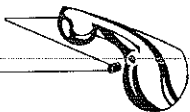

**RP152**  
Set Screw  
Tornillo de Ajuste

**RP16919**  
Handle w/Button & Screw  
Manija con Botón y Tornillo

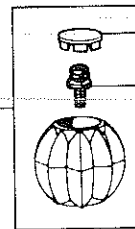

**RP16920**  
Button/Botón

**RP6369**  
Screw/Tornillo

**RP250**  
Adjusting Ring  
Anillo de Ajuste



**RP50**  
Cap w/Adjusting Ring  
Tapón con Anillo de Ajuste

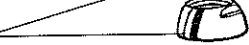

**RP61**  
Cam & Packing  
Leva y Empaque



**RP70**  
Ball Assembly-Stainless Steel  
Ensamble de la Bola-Acero Inoxidable

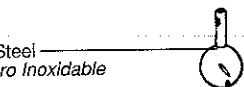

**RP4993**  
Seats & Springs  
Asientos y Resortes

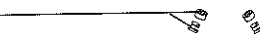

**RP118400S**  
Body Pin  
Espiga

**RP16921**  
Base & Gasket  
Base y Empaque

**RP6417**  
Gasket/Empaque

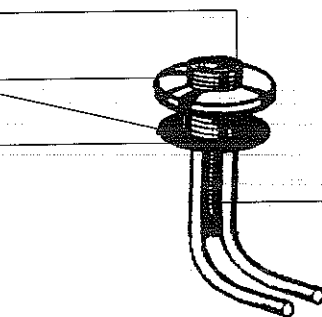

1/4" male threaded  
nipple for spray  
attachment  
Conexión de  
Entrosca para  
Rosca Macho 1/4"  
para el Rocciador

**RP16915**  
Spacer/Separador

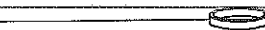

**RP11721**  
Mounting Bracket  
Abrazadera de Montura

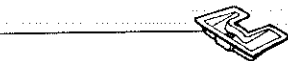

**RP11722**  
Nut & Wrench  
Tuerca y Llave

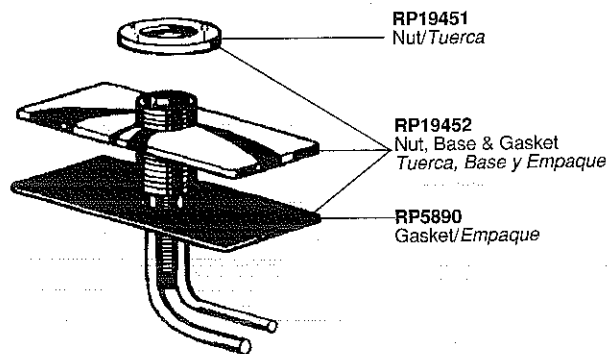
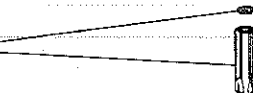

**RP19451**  
Nut/Tuerca

**RP19452**  
Nut, Base & Gasket  
Tuerca, Base y Empaque

**RP5890**  
Gasket/Empaque

**RP3614**  
Repair Kit  
Herramientas para Reparaciones



**RP1974**  
Wrench-Handle/Adjusting Ring  
Llave-Manija/Anillo de Ajuste



\* Discontinued/Descontinuados

# Models/Modelos 2121 & 2123 Series Laundry Tray Faucets/Llaves para la Lavandería

**RP6189**  
Spout Assembly  
Ensamble del Tubo de Salida

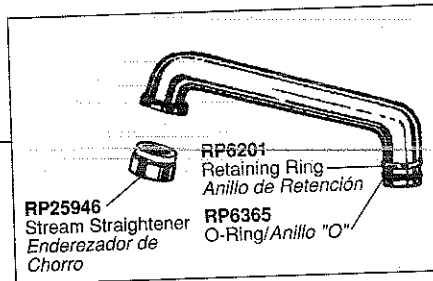

**RP18373**  
Button Set  
(Red/Blue  
Indicators)  
Botones  
(Indicadores:  
Rojo/Azul)

**RP5885**  
Screws  
Tornillos

**H21**  
Handles w/Buttons & Screws  
Manijas con Botones y Tornillos

**RP3541**  
Spout Assembly  
Ensamble del Tubo de Salida

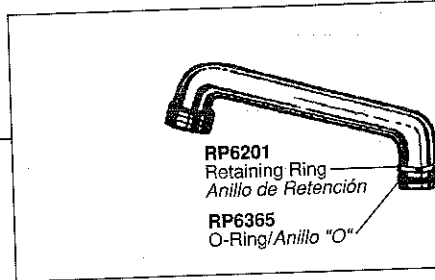

**RP6060**  
Bonnet Nuts  
Bonetes/Capuchones

**RP25695**  
Vacuum Breaker  
Rompedor de Vacío



**RP6197**  
Spout Bonnet  
Bonete del Tubo  
de Salida

**RP2412**  
Button Set  
Botones

**RP1740**  
Stem Unit Assembly-SS Plate  
Ensamble de la Unidad del Vástago-Placa de  
Acero Inoxidable

**H28**  
Handles w/Buttons & Screws  
Manijas con Botones y Tornillos

**RP5885**  
Screws  
Tornillos

**RP4993**  
Seats & Springs  
Asientos y Resortes

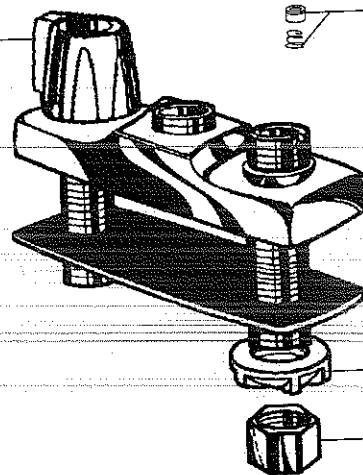



# Specialty Faucets Llaves de Especialidad

Models/Modelos 2302 & 2303-HDF Series  
Basin Faucets/Llaves para Lavamanos

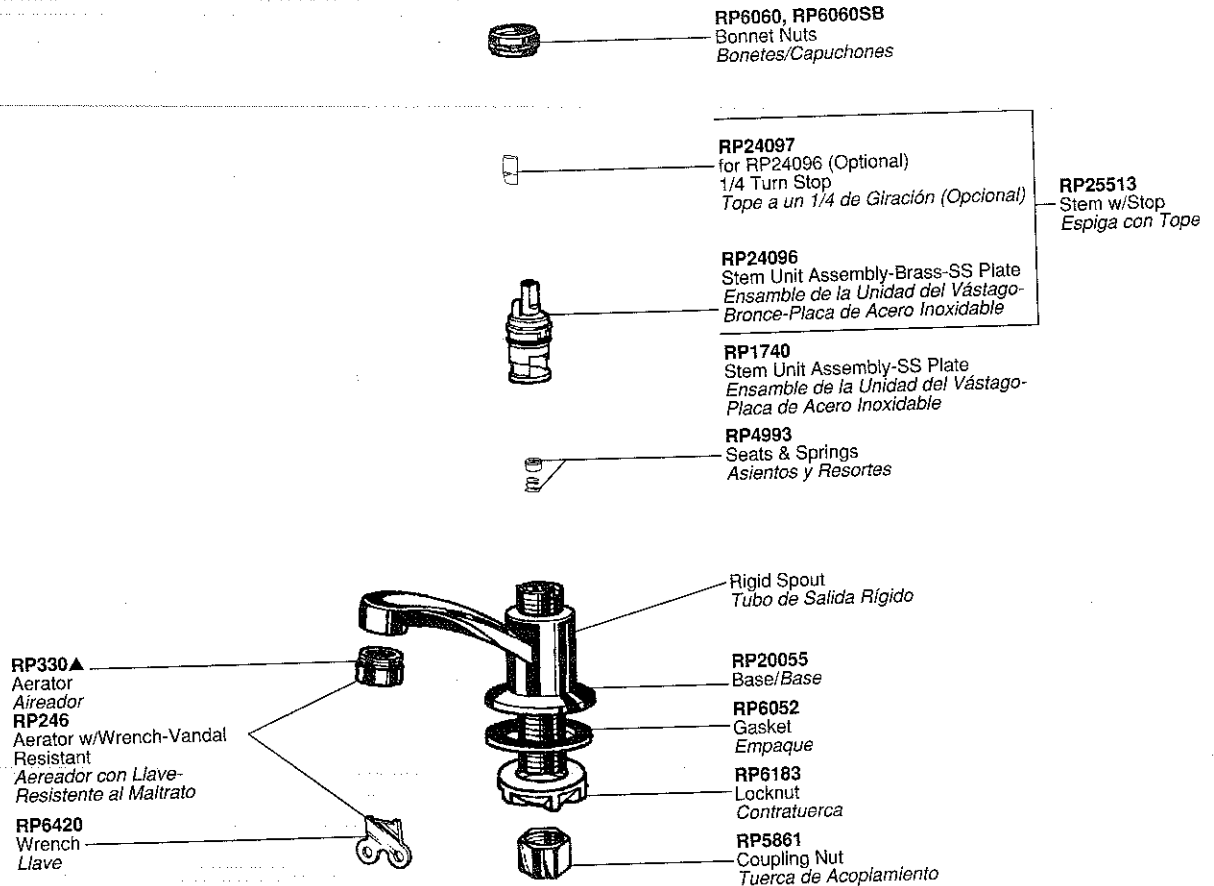

<p><b>OPTIONAL/OPCIONAL</b></p> <p><b>RP8230</b> Ceramic Stem Unit, Seat, O-Ring, Spring &amp; Screw Unidad del Vástago de Cerámica, Asiento, Anillo "O", Resorte y Tornillo</p> <p><b>RP10700</b> Ceramic Seats, O-Rings &amp; Springs Asientos de Cerámica, Anillos "O" y Resortes</p>	<p><b>H31, H31PB</b> Medium Knob Handle w/Button &amp; Screw Perilla Mediana con Botón y Tornillo</p> <p><b>RP18249, RP18249PB</b> Button-Arrow Botón-Flecha</p> <p><b>RP5885</b> Screw/Tornillo</p>	
<p><b>H11, H11PB</b> Small Knob Handle w/Hot, Cold &amp; Arrow Buttons &amp; Screw Perilla Pequeña con Botones y Tornillo</p> <p><b>RP18373, RP18373PB</b> Hot/Cold Button Set (Red/Blue) Botones: Caliente/Fría (Rojo/Azul)</p> <p><b>RP18429, RP18429PB</b>    <b>RP5885</b> Arrow Button/Botón-Flecha    Screw/Tornillo</p>	<p><b>H36, H36AC, H36AP, H36CB, H36PB, H36WC, H36WP</b> Medium Metal Cross Handle w/Screws Manija/Cruz/Metal/Mediana con Tornillos</p> <p><b>RP25620</b> Set Screw/Tornillo de Ajuste</p> <p><b>RP20185</b> Retention Screw Tornillo de Retención</p>	<p><b>H13, H13AL, H13PB, H13WH</b> Small Ring Handle w/Cap &amp; Screw Manija de Anillo Pequeño con Tapa y Tornillo</p> <p><b>RP18342, RP18342AL, RP18342PB, RP18342WH</b> Handle Cap/Casquete de Manija</p> <p><b>RP5885</b> Screw/Tornillo</p>
<p><b>H17, H17PB</b> Small Porcelain Cross Handle w/Screws Manija de Cruz, de Porcelana, Pequeña con Tornillos</p> <p><b>RP25620</b> Set Screw/Tornillo de Ajuste</p> <p><b>RP20185</b> Retention Screw Tornillo de Retención</p>	<p><b>H18 (Plain/Sencilla)</b> <b>RP5210 (Hot/Caliente)</b> <b>RP7828 (Cold/Fría)</b> Small Metal Knob Handle w/Screw Perilla Pequeña, de Metal, con Tornillo</p> <p><b>RP6401</b> Screw-Vandal Resistant Tornillo-Resistente al Maltrato</p>	<p><b>RP18340, RP18340AL, RP18340PB, RP18340WH</b> Handle Base/Base de la Manija</p> <p><b>A13, A13AB, A13AL, A13OK, A13PB, A13ST, A13WH</b> Handle Accent Acento para Manija</p>

See Page 19 for Handle Suffix Chart/Vea la tabla en página 19 para más detalles sobre sufijos de manijas

▲ Designate proper finish suffix. Verify available finishes in Miscellaneous Parts Section. **Note:** Chrome models have no finish suffix. AL=Almond, PB=Polished Brass, WH=White.

▲ *Designe el sufijo apropiado para el acabado. Verifique acabados disponibles en la sección de Piezas Misceláneas. **Nota:** El acabado de los modelos de cromo no tienen sufijo. AL=Almendra, PB=Bronce Pulido, WH=Blanco.*

## Models/Modelos 750 & 752 Series

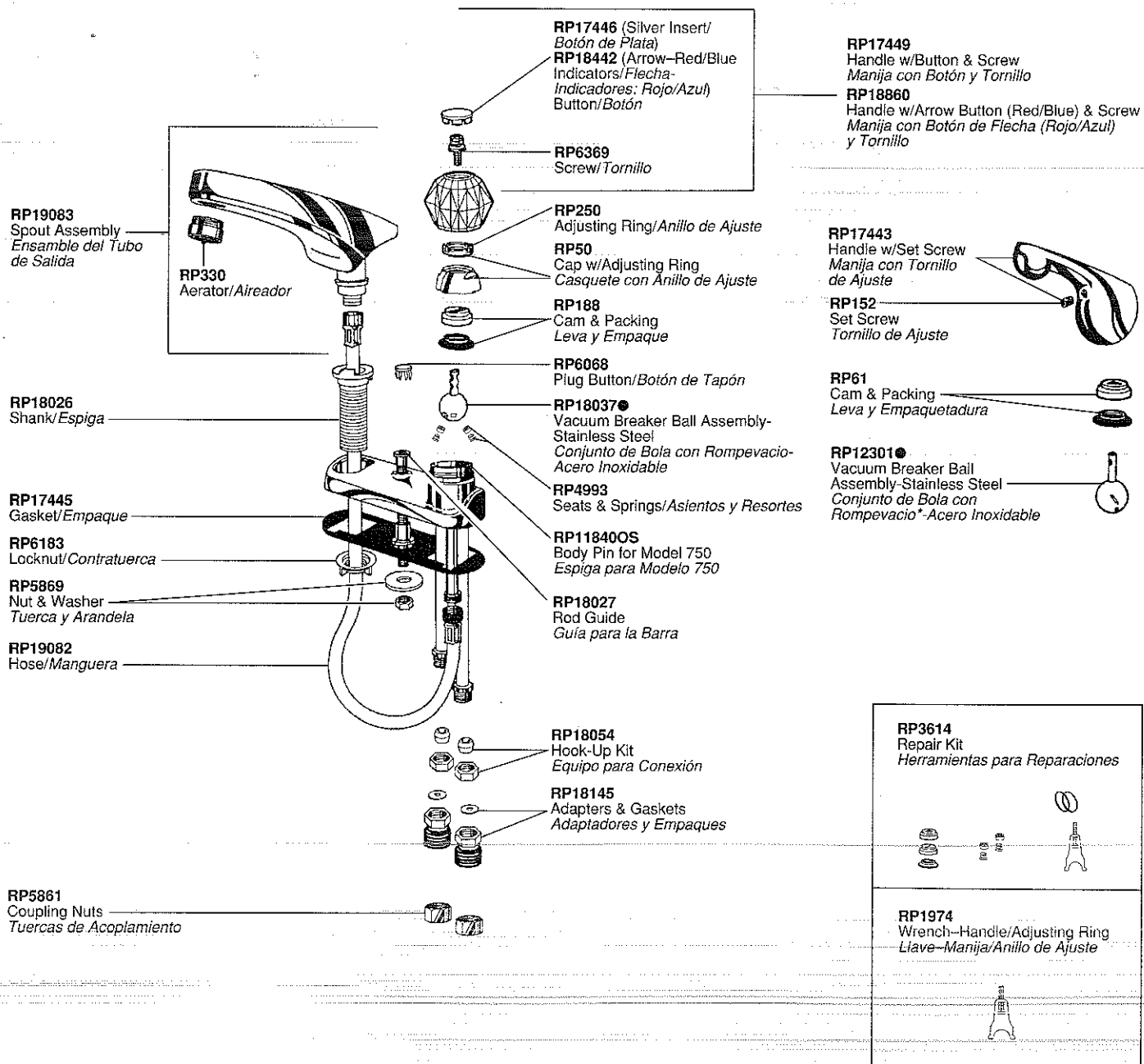

●The vacuum breaker ball assembly is an important part of protecting your drinking water from contamination by back siphonage. Use only the Delta RP18037 or RP12301 ball assembly.

●El conjunto de bola con rompevacío es una parte importante en proteger su agua potable de contaminación por causa del retrosedimiento de agua. Use sólo el conjunto de bola Delta RP18037 o RP12301.

# Specialty Faucets Llaves de Especialidad

## Model/Modelo 701-HDF Series Slow Self-Close Basin Faucets/Llaves de Fregaderos de Cierre Automático Lento

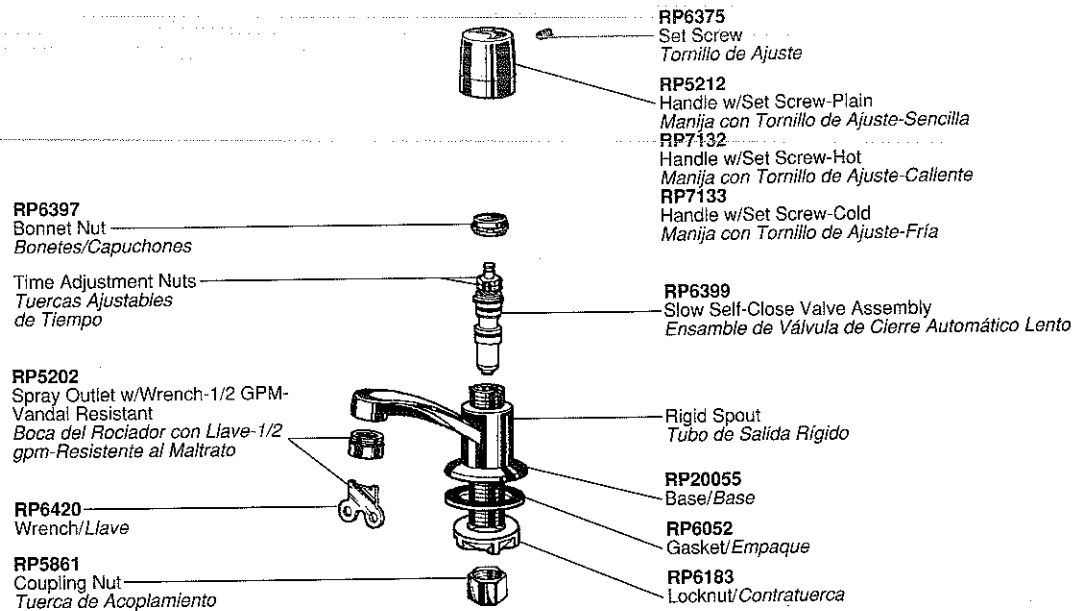

## Models/Modelos 2507-HDF, 2517-HDF & 2527-HDF Series Slow Self-Close Lavatory Faucets/Llaves de Lavamanos de Cierre Automtico Lento

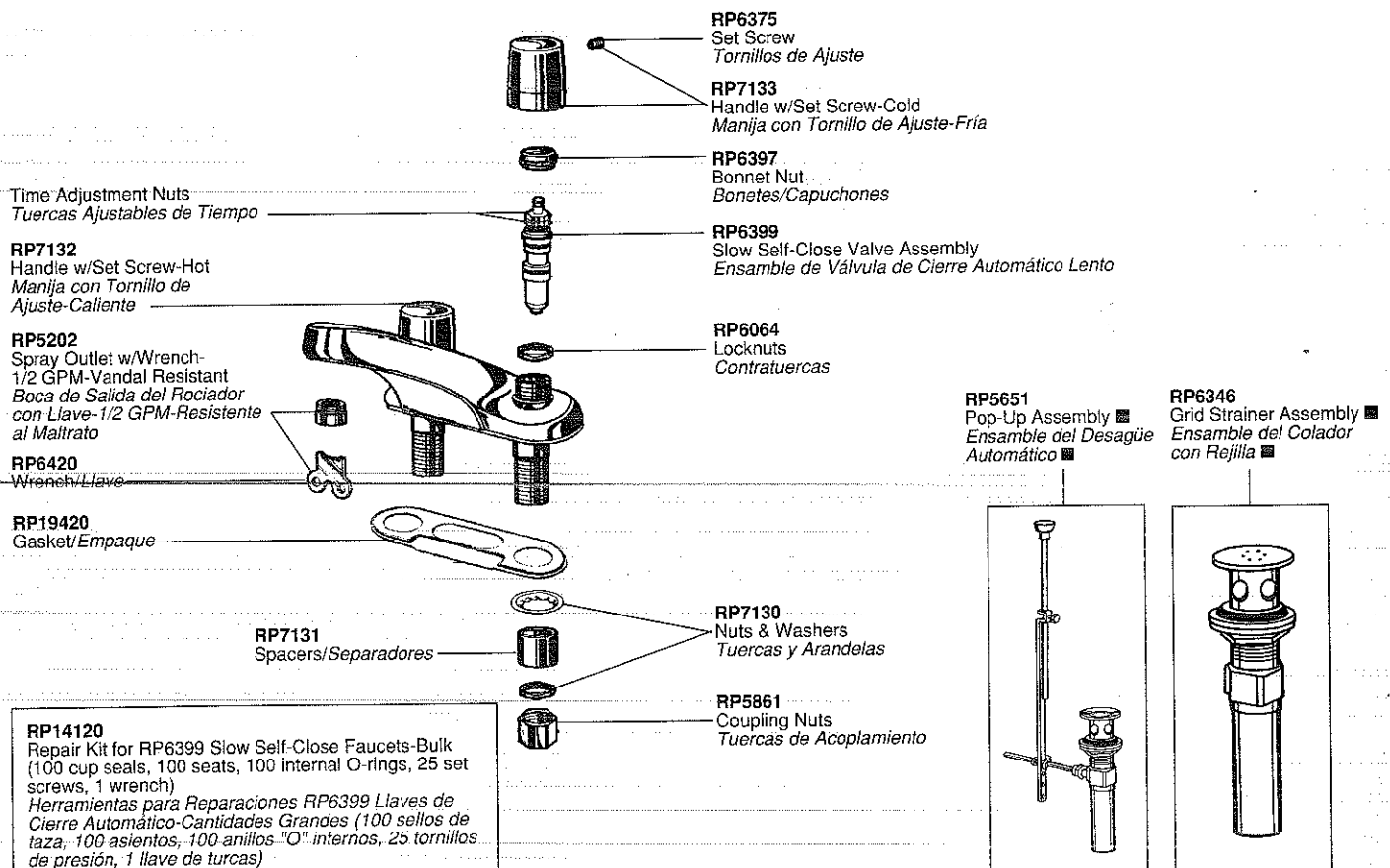

Refer to pages 44 & 45 for lavatory drain assemblies. Para ensamblajes de drenaje para lavamanos refi rse a la pgina 44 y 45.

# Models/Modelos 3507-WFHDF, 3514-WFHDF & 3517-WFHDF\* Series Slow Self-Close Lavatory Faucets/Llaves de Lavamanos de Cierre Automático Lento

**RP20666**  
Spout Assembly  
Ensamble del Tubo de Salida

**RP20669**  
Spout Assembly—1/2 GPM—Vandal Resistant Aerator  
No Lift Rod Hole  
Ensamble del Tubo de Salida—1/2 GPM—Resistente al Maltrato de Aireador—Sin Huecos para Desbordos

**RP5202**  
Spray Outlet w/Wrench—1/2 GPM—Vandal Resistant  
Boca de Salida del Rociador con Llave—1/2 GPM—Resistente al Maltrato

**RP6420**  
Wrench/Llave

**RP17741**  
Base & Gasket  
Base y Empaque

**RP6087**  
Nut & Washer  
Tuerca y Arandela

**RP5202**  
Spray Outlet w/Wrench—1/2 GPM—Vandal Resistant  
Boca de Salida del Rociador con Llave—1/2 GPM—Resistente al Maltrato de Aireador

**RP6420**  
Wrench/Llave

**RP18418**  
Base Plate  
Placa

**RP6087**  
Nut & Washer  
Tuerca y Arandela

**RP6375**  
Set Screw  
Tornillo de Ajuste

**RP7132**  
Handle w/Set Screw—Hot  
Manija con Tornillo de Ajuste—Caliente

Inlet Tubes Install  
Away From Spout  
Tubos de Entrada se  
Instalan en Sentido  
Opuesto del Tubo de  
Salida

Time Adjustment Nuts  
Tuercas Ajustables  
de Tiempo

**RP6375**  
Set Screw  
Tornillo de Ajuste

**RP7133**  
Handle w/Set Screw—Cold  
Manija con Tornillo de Ajuste—Fría

**RP6397**  
Bonnet  
Bonetes

**RP6399**  
Slow Self-Close  
Valve Assembly  
Ensamble de Válvula  
de Cierre  
Automático, Lento

**RP12506**  
End Valve Assembly—  
WF (IPS Adapter)  
Ensamble de la  
Válvula Final—WF  
(Adaptador de IPS)

**RP6052**  
Gasket/Empaque

**RP6054**  
Nuts & Washers  
Tuercas y Arandelas

**RP11887**  
Hose-Braided Stainless Steel  
Manguera Trenzada de Acero Inoxidable

IPS Adapters  
Adaptadores de IPS

**RP5861**  
Coupling Nuts  
Tuercas de Acoplamiento

**RP6346**  
Grid Strainer Assembly ■  
Ensamble del Colador con  
Rejilla ■

**RP14120**  
Repair Kit for RP6399 Slow Self-Close  
Bulk (100 cup seals, 100 seats, 100 internal  
o-rings, 25 set screws, 1 wrench)  
Herramientas para Reparaciones RP6399 Llaves  
de Cierre Automático—Cantidades Grandes (100  
sellos de taza, 100 asientos, 100 anillos "O"  
internos, 25 tornillos de presión, 1 llave de tuercas)

**RP10612**  
**RP11096** (Bulk Kit/Equipo de Cantidades Grandes)  
Thick Tile Mounting Kit  
Equipo/Herramientas para Montar en Losa Gruesa

# Specialty Faucets Llaves de Especialidad

Models/Modelos 710-WFHDF & 711-WFHDF Series  
Utility Faucets/Llaves para Servicio General

**RP5645**  
Handle w/Set Screw-  
Red/Blue Indicators  
Manija con Tornillo de Ajuste-  
Indicadores: Rojo/Azul

**RP152**  
Set Screw  
Tornillo de Ajuste

**RP250**  
Adjusting Ring/Anillo de Ajuste

**RP50**  
Cap w/Adjusting Ring  
Tapón con Anillo de Ajuste

**RP61**  
Cam & Packing/Leva y Empaque

**RP70**  
Ball Assembly-Stainless Steel  
Ensamble de la Bola-Acero  
Inoxidable

**RP5887**  
Escutcheon/Chapetón

**RP4993**  
Seats & Springs  
Asientos y Resortes

**RP25**  
O-Rings/Anillos "O"

**RP5786**  
Base w/Gasket  
Base con Empaque

**RP5857**  
Gasket/Empaque

**RP6893**  
Washer/Arandela

**RP12691**  
Spacer/Separador

**RP5785**  
Nut & Wrench  
Tuerca y Llave

**RP7457**  
Spout Assembly-Rigid  
Ensamble del Tubo de  
Salida-Rígido

**RP19897**  
Spray Outlet-Laminar  
Flow -Non-Vandal  
Resistant  
Boca del  
Rociador-Flujo  
Laminar-Sin  
Resistente al  
Maltrato

**RP19897**  
Spray Outlet-Laminar  
Flow -Non-Vandal  
Resistant  
Boca del Rociador-  
Flujo Laminar-Sin  
Resistente al Maltrato

**RP5102**  
O-Ring/Anillo "O"

**RP5582**  
Spout Bonnet  
Bonete del  
Tubo de Salida

**RP6052**  
Gasket/Empaque

**RP17909**  
Body Assembly  
Ensamble de  
Cuerpo

**RP6056**  
Nut & Washer  
Tuerca y Arandela

**RP5861**  
Coupling Nuts-WF Models Only  
Tuercas de Acoplamiento-  
Sólo Modelos WF

**RP11887**  
Hose-Braided Stainless Steel  
Manguera Trenzada de Acero Inoxidable

## OPTIONAL/OPCIONAL

**RP246**  
Aerator w/Wrench-Vandal Resistant  
Airaador con Llave-Resistente al Maltrato

**RP5202**  
Spray Outlet w/Wrench-1/2 GPM-Vandal Resistant  
Boca de Salida del Rociador con Llave-1/2 gpm-  
Resistente al Maltrato

**RP21966**  
Spray Outlet w/Wrench-Laminar Flow-Vandal Resistant  
Boca de Salida del Rociador con Llave-Flujo Laminar-  
Resistente al Maltrato



**RP3614**  
Repair Kit  
Herramientas para Reparaciones



**RP1974**  
Wrench-Handle/Adjusting Ring  
Llave-Manija/Anillo de Ajuste



# Model/Modelo 3579-HDF Series Widespread Utility Faucets/Llaves para Servicio General

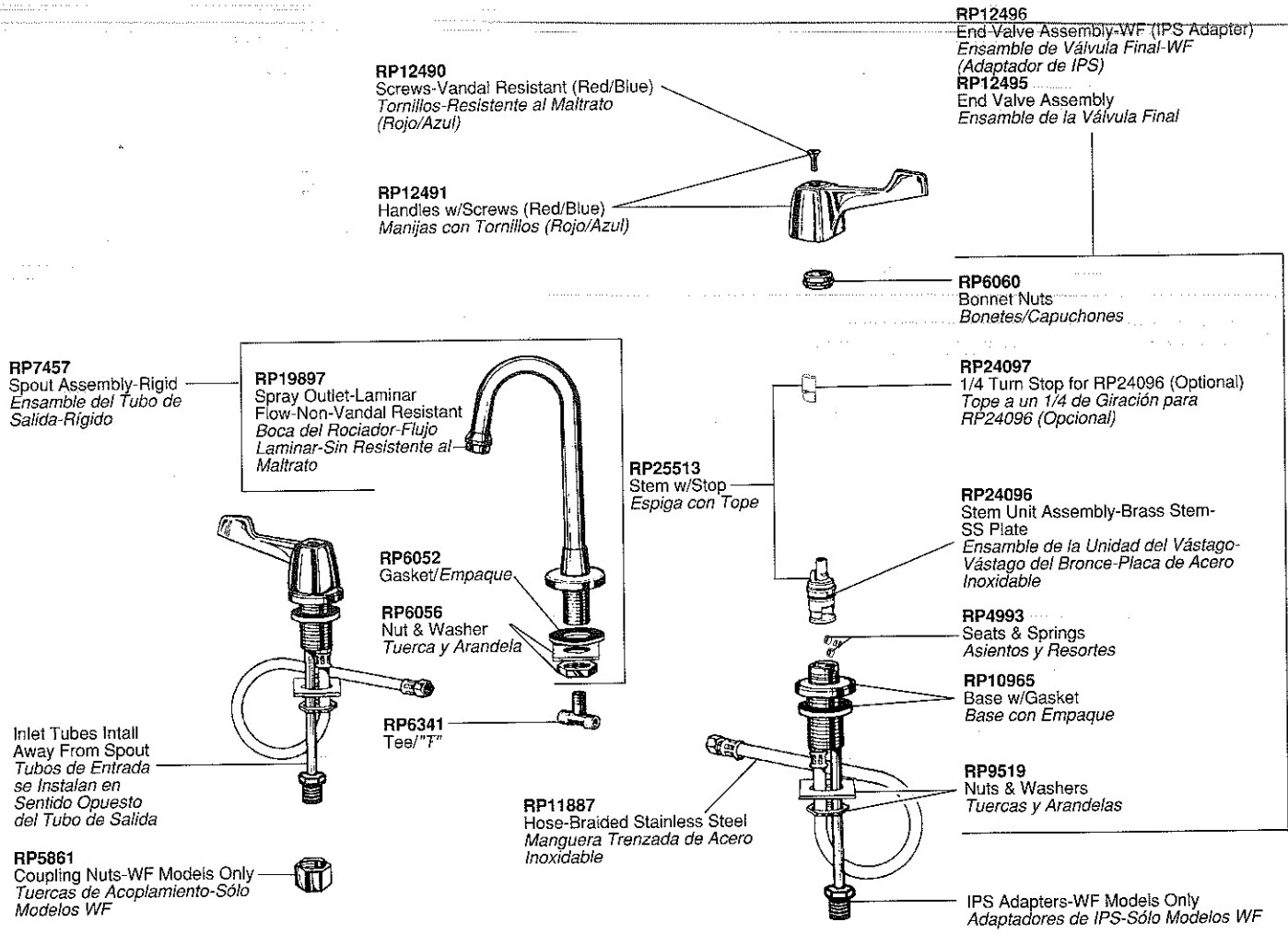

**RP22132**  
Helpful Hand Installation Aid  
Utensilio para Asistencia en Instalaciones a Mano

**RP11052**  
**RP11016** (Bulk Kit/Equipo de Cantidades Grandes)  
Thick Tile Mounting Kit  
Equipo/Herramientas para Monturas en Losa Gruesa

**OPTIONAL/OPCIONAL**

**RP246**  
Aerator w/Wrench-Vandal Resistant  
Aireador con Llave-Resistente al Maltrato

**RP5202**  
Spray Outlet w/Wrench-1/2 GPM-Vandal Resistant  
Boca de Salida del Rociador con Llave-1/2 gpm-Resistente al Maltrato

**RP21966**  
Spray Outlet w/Wrench-Laminar Flow-Vandal Resistant  
Boca de Salida del Rociador con Llave-Flujo Laminar-Resistente al Maltrato

**OPTIONAL/OPCIONAL**

**RP8230**  
Ceramic Stem Unit, Seat, O-Ring, Spring & Screw  
Unidad del Vástago de Cerámica, Asiento, Anillo "O", Resorte y Tornillo



**RP10700**  
Ceramic Seats, O-Rings & Springs  
Asientos de Cerámica, Anillos "O" y Resortes

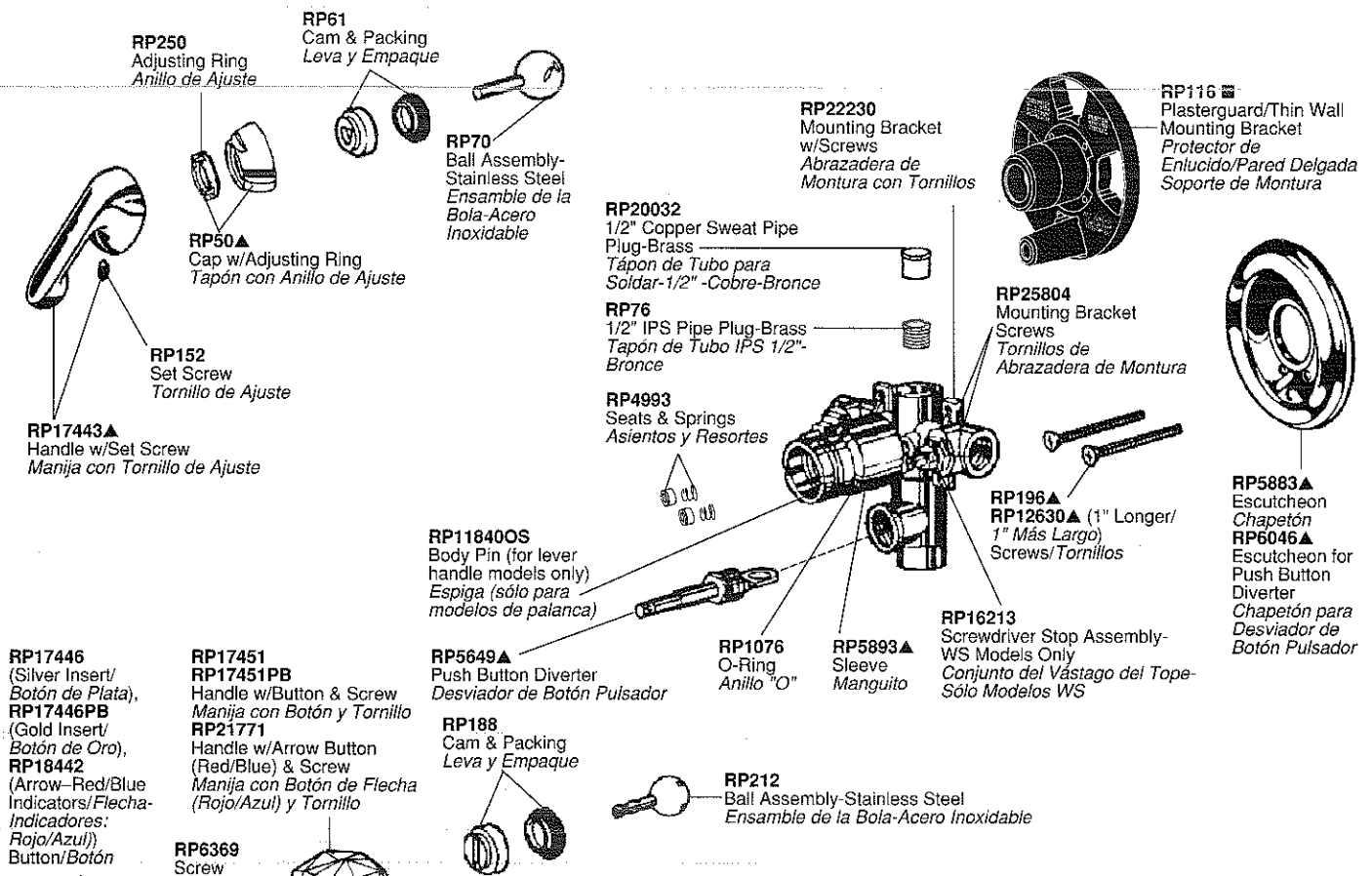

# Single Handle Bath Valves

## Válvulas de Una Manija (Maneral) para Bañeras

Models/Modelos 601, 602, 606, 611, 612, 621, 622,  
635, 636, 641 & 642 Series  
Non-Pressure Balance Models/Modelos sin Presión Balanceada

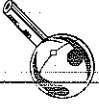
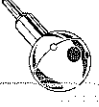
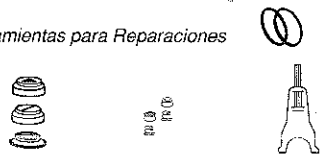
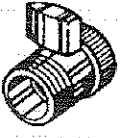
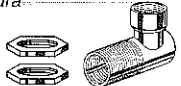
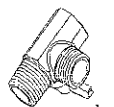
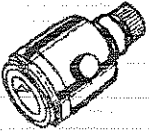
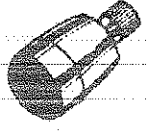

<p><b>RP6005</b> Complete Screwdriver Stop-1/2" CWT Tope Destornillador Completo-1/2" CWT</p> 	<p><b>RP5876</b> Complete Screwdriver Stop-1/2" IPS Tope Destornillador Completo-1/2" IPS</p> 
--	---

<p><b>RP16423</b> Reverse Ball-Stainless Steel (Corrects Reverse Supply Lines for Knob Handle Models Only) / Bola de Inversión-Acero Inoxidable (Corrije las Líneas de Contraflujo para Sólo Modelos Manija de Perilla)</p> 	<p><b>RP20111</b> Conversion Ball-Stainless Steel (Changes Knob to Lever Handle) / Bola de Inversión-Acero Inoxidable (Cambia de Perilla a Manija de Palanca)</p> 	<p><b>RP3614</b> Repair Kit / Equipo/Herramientas para Reparaciones</p> 
<p><b>RP6124</b> Showerhead Adjustable Volume Control / Cabeza de Regadera con Control de Volumen</p> 	<p><b>RP5844</b> <b>RP11077</b> (Bulk Kit/Equipo de Cantidades Grandes) Thin Wall Shower Arm or Tub Spout Mounting Kit / Brazo de Regadera para Paredes Delgadas o Herramientas para la Montura del Tubo de Bañera</p> 	<p><b>RP4239</b> Shower Arm Diverter for Handshower / Desviador de Brazo Regadera para Regadera de Mano</p> 
<p><b>RP6152</b> (Metal/Metálico) / <b>RP6218</b> Pulsating Showerhead / Cabeza de Regadera Pulsante</p> 	<p><b>RP6122</b> Showerhead / Ducha</p> 	<p><b>RP6023</b> Shower Arm / Brazo de Regadera</p>   <p><b>RP6025</b> Shower Flange / Chapetón de Regadera</p> 

▲ Designate proper finish suffix. Verify available finishes in Miscellaneous Parts Section. **Note:** Chrome models have no finish suffix. AB=Antique Brass, AL=Almond, PB=Polished Brass, SB=Satin Brass, WH=White.

▲ Designe el sufijo apropiado para el acabado. Verifique acabados disponibles en la sección de Piezas Misceláneas. **Nota:** El acabado de los modelos de cromo no tienen sufijo. AB=Bronce Antiguo, AL=Almendra, PB=Bronce Pulido, SB=Bronce Satinado, WH=Blanco.

## Models/Modelos 603\*, 604\*, 623\*, 624\*, 637\*, 638\*, 643\* & 644\* Series Pressure Balance Models/Modelos con Presión Balanceada

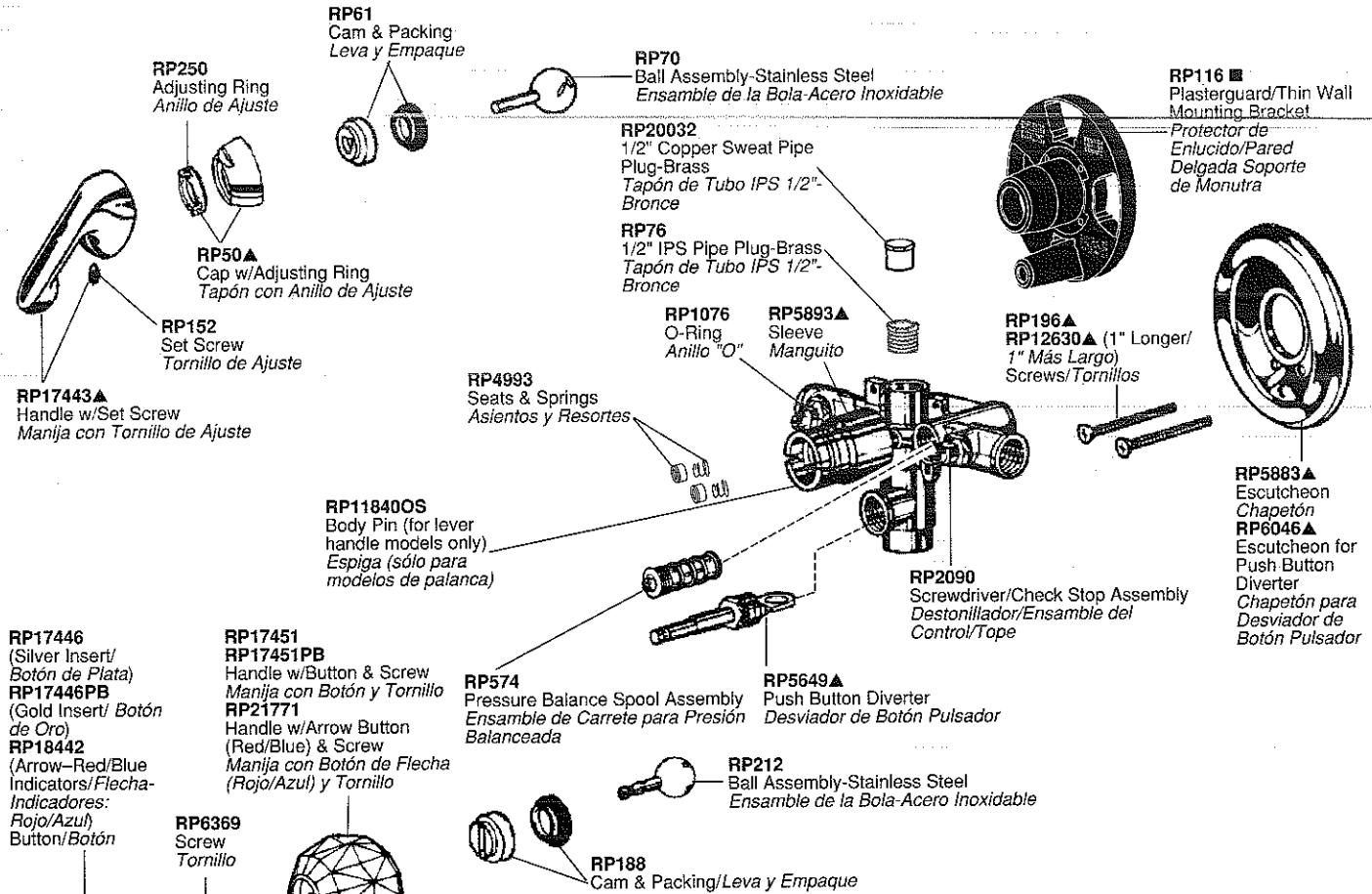

\*Discontinued/Descontinuados

**RP1974** Wrench-Handle/Adjusting Ring / Llave-Manija/Anillo de Ajuste



**RP8655** Stainless Steel Liner Repair Kit / Herramientas de Acero Inoxidable para Reparaciones de Tuberías

**RP2865** Push Button Diverter Plug / Tapón Desviador con Botón Pulsador



**RP17498** Temp. Indicator Label for Escutcheon (Red/Blue) / Etiqueta que Indica la Temperatura para Colocar en el Chapetón (Rojo/Azul)

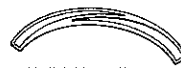

**RP3888** Thin Wall Mounting Bracket for 600 Series w/Clear Knob Handle w/Stops / Soporte para Montura en Paredes Delgadas para Series 600 con Perilla Transparente y Topes



**RP557▲** Shower Cover-Up Plate / Placa de Cubierta para la Regadera



**RP16595▲** Deep Escutcheon for Push Button Diverter (1" Deeper) / Chapetón Hondo para Desviador con Botón Pulsador (1" Más Hondo)



**RP6019▲** Deep Escutcheon (1" Deeper) / Chapetón Hondo (1" Más Hondo)



**RP5833▲** (Metal/Metálico) Tub Spout/Non-Diverter / Tubo de Salida para Bañera/Sin Desviador



**RP5834** (Metal/Metálico) Tub Spout/Pull-Up Diverter / Tubo de Salida para Bañera/Botón Desviador de Alzar



**RP17453** / **RP17454▲** (Metal/Metálico) Tub Spout/Pull-Down Diverter / Tubo de Salida para Bañera/Desviador de Halar

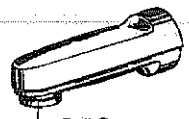

Pull-Down Halar Hacia Abajo



# Single Handle Monitor® Bath Valves

## Válvulas de Una Manija Monitor® para Bañeras

Models/Modelos 1300 & 1400 Series  
 Pressure-Balance Models/Modelos con Presión Balanceada

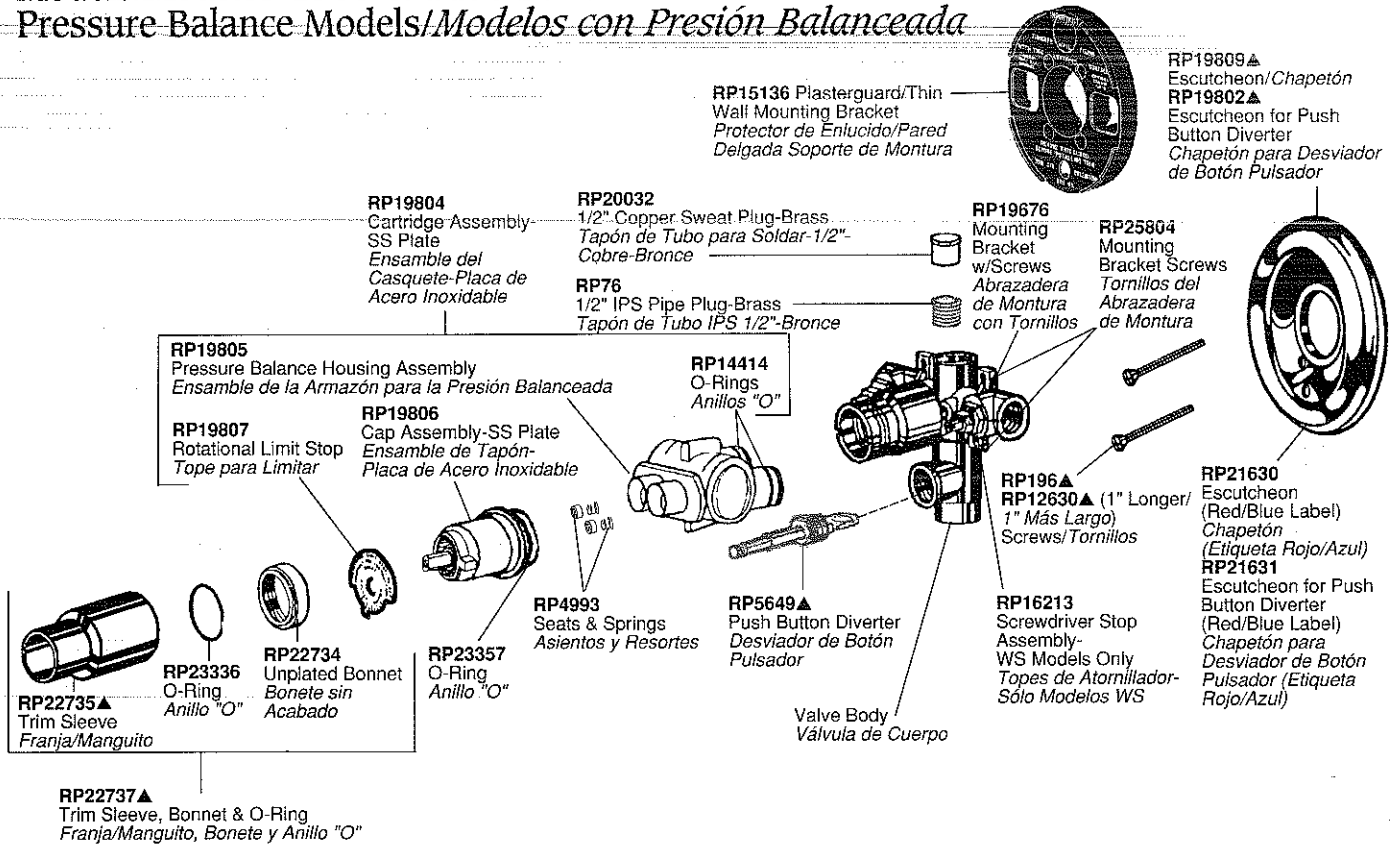

**H75, H75AC, H75AP, H75CA, H75CB, H75CK, H75CW, H75PA, H75PB, H75PK, H75PW, H75WC, H75WP**  
 Large Lever Handle w/Screw  
 Manija Grande de Palanca con Tornillo

**RP26865**  
 Set Screw  
 Tornillo de Ajuste

**H79, H79AB, H79AL, H79PB, H79WH**  
 Large Lever Handle w/Screw  
 Manija Grande de Palanca con Tornillo

**RP152, RP152AL, RP152WH**  
 Set Screw  
 Tornillo de Ajuste

**H77, H77PB**  
 Porcelain Cross Handle w/Screw  
 Manija de Cruz de Porcelana, con Tornillo

**RP26865**  
 Set Screw  
 Tornillo de Ajuste

**H71, H71PB**  
 Knob Handle w/Button & Screw  
 Perilla con Botón y Tornillo

**RP20542, RP20542PB**  
 Button (Red/Blue)  
 Botón (Rojo/Azul)

**RP6369**  
 Screw/Tornillo

**H78**  
 Large Blade Handle w/Screw  
 Manija de Tipo Aleta Grande con Tornillo

**RP6119**  
 Screw/Tornillo

**H72, H72AB, H72AL, H72PB, H72WH**  
 Large Lever Handle w/Screw  
 Manija Grande de Palanca con Tornillo

**RP26865**  
 Set Screw  
 Tornillo de Ajuste

**H73, H73AB, H73AL, H73PB, H73WH**  
 Large Ring Handle w/Cap & Screw  
 Manijas de Anillo Grande con Casquetes y Tornillo

**RP18343, RP18343AB, RP18343AL, RP18343PB, RP18343WH**  
 Handle Cap/Casquete del Manija

**RP6369**  
 Screw/Tornillo

**RP18341, RP18341AB, RP18341AL, RP18341PB, RP18341WH**  
 Handle Base/Base de la Manija

**H74, H74AL, H74PB, H74WH**  
 Large Lever Handle w/Screw  
 Manija Grande de Palanca con Tornillo

**RP26865**  
 Set Screw  
 Tornillo de Ajuste

**A72, A72AB, A72AL, A72CL, A72OK, A72PB, A72PR, A72RS, A72WH, A72WH**  
 Handle Accent/Acento para Manija





**A73, A73AB, A73AL, A73OK, A73PB, A73ST, A73WH**  
 Handle Accent/Acento para Manija

**A74, A74AL, A74CL, A74PB, A74WH**  
 Handle Accent/Acento para Manija

See Page 19 for Handle Suffix Chart. Vea la table en página 19 para más detalles sobre sufijos de manijas.

▲ Designate proper finish suffix. Verify available finishes in Miscellaneous Parts Section. **Note:** Chrome models have no finish suffix. AB=Antique Brass, AL=Almond, CB=Chrome/Polished Brass, PB=Polished Brass, WC=White with Chrome, WH=White, WP=White/Polished Brass.

▲ *Designe el sufijo apropiado para el acabado. Verifique acabados disponibles en la sección de Piezas Misceláneas. Nota: El acabado de los modelos de cromo no tienen sufijo. AB=Bronce Antiguo, AL=Almendra, CB=Cromo/Bronce Pulido, PB=Bronce Pulido, WC=Blanco con Cromo, WH=Blanco, WP=Blanco/Bronce Pulido.*

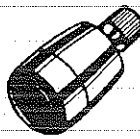
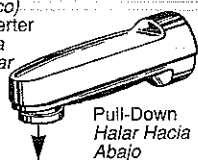
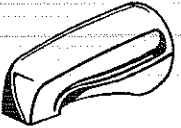
<p><b>RP5876</b> Complete Screwdriver Stop-1/2" IPS <i>Tope Destornillador Completo-1/2: IPS</i></p> 	<p><b>RP6005</b> Complete Screwdriver Stop-1/2" CWT <i>Tope Destornillador Completo-1/2" CWT</i></p> 	<p><b>RP2865</b> Push Button Diverter Plug <i>Tapón Desviador con Botón Pulsador</i></p> 
<p><b>RP21633▲</b> Deep Escutcheon (1" Deeper) <i>Chapetón/Escudete Hondo (1" Más Hondo)</i></p> 	<p><b>RP21634▲</b> Deep Escutcheon for Push Button Diverter (1" Deeper) <i>Chapetón Hondo para Desviador con Botón Pulsador (1" Más Hondo)</i></p> 	<p><b>RP557▲</b> Shower Cover-Up Plate <i>Placa de Cubierta para la Regadera</i></p> 
<p><b>RP17498</b> Temp. Indicator Label for Escutcheon-For RP21630 &amp; RP21631 Only (Red/Blue) <i>Etiqueta que Indica la Temperatura para Colocar en el Chapetón-para sólo RP21630 y RP21631 (Rojo/Azul)</i></p> 	<p><b>RP5844</b> <b>RP11077 (Bulk Kit/Equipo de Cantidades Grandes)</b> Thin Wall Shower Arm or Tub Spout Mounting Kit <i>Brazo de Regadera para Paredes Delgadas o Herramientas para la Montura del Tubo de Bañera</i></p> 	<p><b>RP4239</b> Shower Arm Diverter for Handshower <i>Desviador de Braza de Regadera para Regadera de Mano</i></p> 
<p><b>RP6124▲</b> Showerhead Adjustable Volume Control <i>Cabeza de Regadera con Control de Volumen</i></p> 	<p><b>76262</b> Institutional Showerhead <i>Ducha de Institución</i></p> 	<p><b>RP6023▲</b> Shower Arm <i>Braza de Regadera</i></p>  <p><b>RP6025▲</b> Shower Flange <i>Chapetón de Regadera</i></p> 
<p><b>RP6212</b> Adjustable Volume Control Showerhead <i>Cabeza de Regadera de Control Volumen</i></p> 	<p><b>RP6122</b> Showerhead <i>Ducha</i></p> 	<p><b>RP6152▲ (Metal/Metálico)</b> <b>RP6218</b> Pulsating Showerhead <i>Cabeza de Regadera Pulsante</i></p> 
<p><b>RP17453</b> <b>RP17454▲ (Metal/Metálico)</b> Tub Spout/Pull-Down Diverter <i>Tubo de Salida Agua para Bañera/Desviador de Halar</i></p>  <p>Pull-Down Halar Hacia Abajo</p>	<p><b>RP5834</b> <b>RP7533▲ (Metal/Metálico)</b> Tub Spout/Pull-Up Diverter <i>Tubo de Salida para Bañera/Botón Desviador de Alzar</i></p> 	<p><b>RP5833▲</b> Tub Spout/Non-Diverter (Metal) <i>Tubo de Salida para Bañera/Sin Desviador (Metálico)</i></p> 

# Single Handle Monitor® Bath Valves Válvulas de Una Manija Monitor® para Bañeras

Models/Modelos 1500 Series  
Pressure Balance Models/Modelos de Presión Balanceada

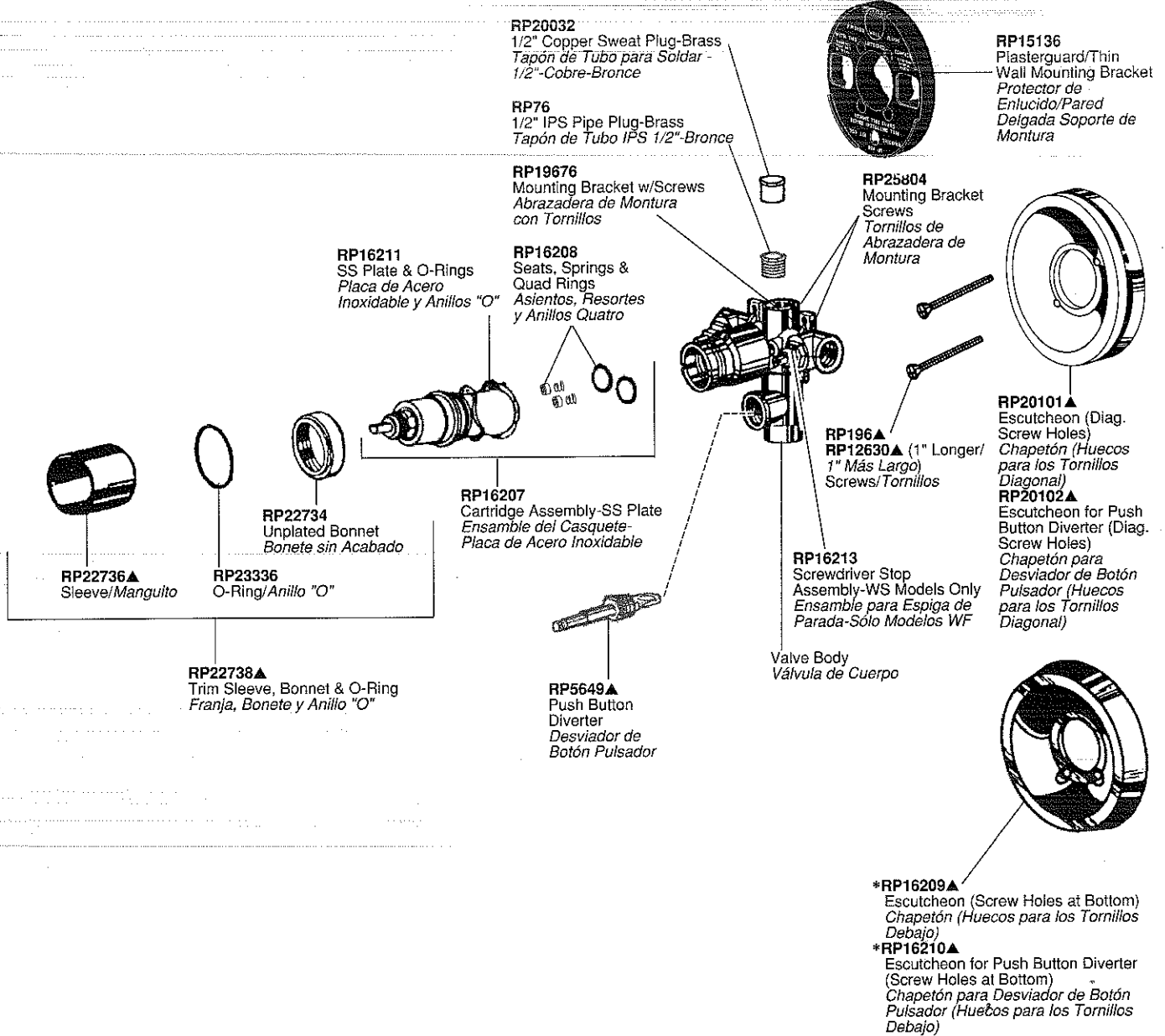



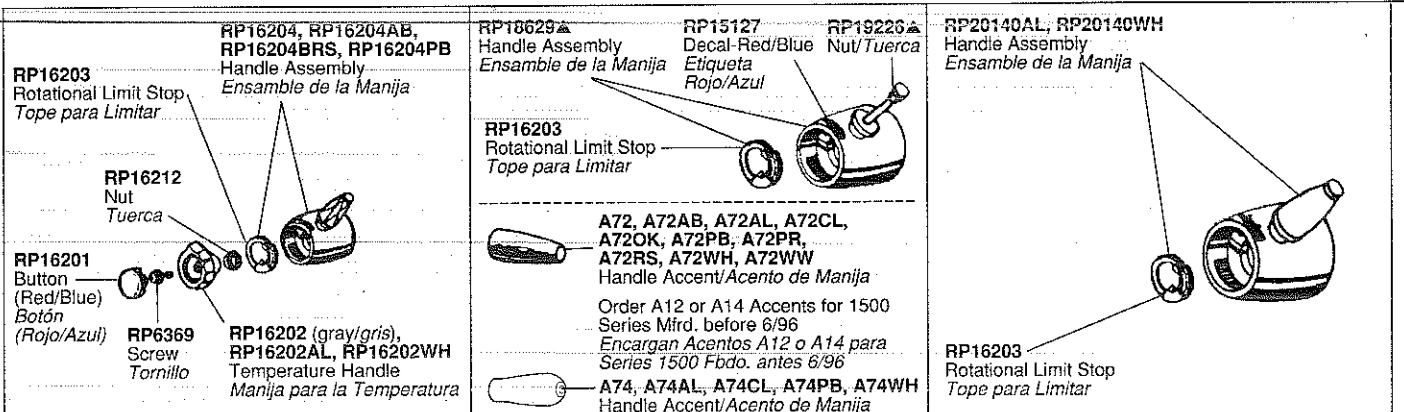







\*Discontinued/Descontinuados

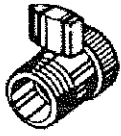
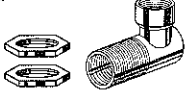

See Page 19 for Handle Suffix Chart/Vea la tabla en página 19 para más detalles sobre sufijos de manijas

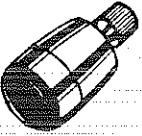
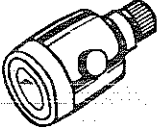
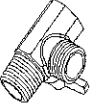
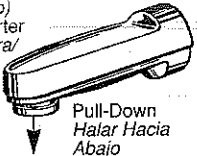
▲ Designate proper finish suffix. Verify available finishes in Miscellaneous Parts Section. **Note:** Chrome models have no finish suffix. AB=Antique Brass, AL=Almond, PB=Polished Brass, WH=White.

▲ Designe el sufijo apropiado para el acabado. Verifique acabados disponibles en la sección de Piezas Misceláneas. **Nota:** El acabado de los modelos de cromo no tienen sufijo. AB=Bronce Antiguo, AL=Almendra, PB=Bronce Pulido, WH=Blanco.

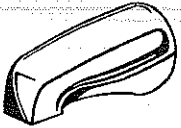
<p><b>RP5876</b> Complete Screwdriver Stop-1/2" IPS <i>Tope Destornillador Completo-1/2" IPS</i></p> 	<p><b>RP6005</b> Complete Screwdriver Stop-1/2" CWT <i>Tope Destornillador Completo-1/2" CWT</i></p> 	<p><b>RP8655</b> Stainless Steel Liner Repair Kit <i>Herramientas de Acero Inoxidable para Reparaciones de Tuberías</i></p>
<p><b>RP21633▲</b> Deep Escutcheon (1" Deeper) <i>Chapetón Hondo (1" Más Hondo)</i></p> 	<p><b>RP21634▲</b> Deep Escutcheon for Push Button Diverter (1" Deeper) <i>Chapetón Hondo para Desviador con Botón Pulsador (1" Más Hondo)</i></p> 	<p><b>RP2865</b> Push Button Diverter Plug <i>Tapón Desviador con Botón Pulsador</i></p> 
<p><b>RP6124▲</b> Showerhead Adjustable Volume Control <i>Cabeza de Regadera con Control de Volumen</i></p> 	<p><b>RP5844</b> <b>RP11077</b> (Bulk Kit/Equipo de Cantidades Grandes) Thin Wall Shower Arm or Tub Spout Mounting Kit <i>Brazo de Regadera para Paredes Delgadas o Herramientas para la Montura del Tubo de Bañera</i></p> 	<p><b>RP557▲</b> Shower Cover-Up Plate <i>Placa de Cubierta para la Regadera</i></p> 
<p><b>RP6122</b> Showerhead <i>Ducha</i></p> 	<p><b>RP6152▲</b> (Metal/Metálico) <b>RP6218</b> Pulsating Showerhead <i>Cabeza de Regadera Pulsante</i></p> 	<p><b>RP4239</b> Shower Arm Diverter for Handshower <i>Desviador de Brazo Regadera para Regadera de Mano</i></p> 
<p><b>RP17453</b> <b>RP17454▲</b> (Metal/Metálico) Tub Spout/Pull-Down Diverter <i>Tubo de Salida para Bañera/Desviador de Halar</i></p>  <p>Pull-Down Halar Hacia Abajo</p>	<p><b>RP5834</b> <b>RP7533▲</b> (Metal/Metálico) Tub Spout/Pull-Up Diverter <i>Tubo de Salida para Bañera/Botón Desviador de Alzar</i></p> 	<p><b>RP6023▲</b> Shower Arm <i>Brazo de Regadera</i></p>  <p><b>RP6025▲</b> Shower Flange <i>Chapetón de Regadera</i></p> 
		<p><b>RP5833▲</b> (Metal/Metálico) Tub Spout/Non-Diverter <i>Tubo de Salida para Bañera/Sin Desviador</i></p> 







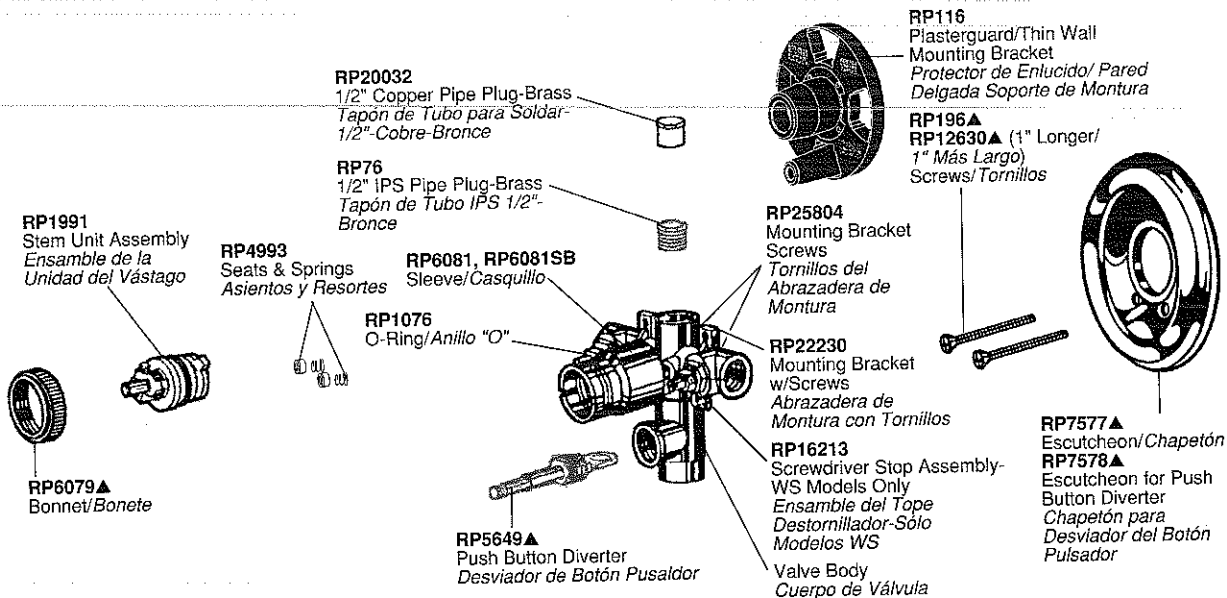

# Single Handle Bath Valves

## Válvulas de Una Manija para Bañeras

Models/Modelos 1600\* Series  
 Non-Pressure Balance Models/Modelos Sin Presión Balanceada

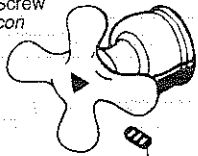
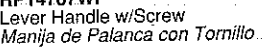

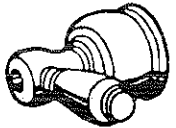
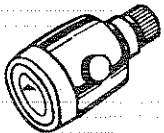
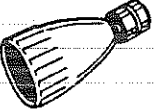
\*Discontinued/Descontinuados

<p><b>RP5876</b> Complete Screwdriver Stop-1/2" IPS <i>Tope Destornillador Completo-1/2" IPS</i></p> 	<p><b>RP6005</b> Complete Screwdriver Stop-1/2" CWT <i>Tope Destornillador Completo-1/2" CWT</i></p> 	
<p><b>RP8655</b> Stainless Steel Liner Repair Kit <i>Herramientas de Acero Inoxidable para Reparaciones de Tuberías</i></p>	<p><b>RP17498</b> Label-Red/Blue <i>Etiqueta-Rojo/Azul</i></p> 	<p><b>RP2865</b> Push Button Diverter Plug <i>Tapón Desviador del Botón Pulsador</i></p> 
<p><b>RP19532, RP19532PB</b> Porcelain Cross Handle w/Screw <i>Manija de Cruz Porcelana con Tornillo</i></p> 	<p><b>RP14787, RP14787CB, RP14787CW, RP14787OAK, RP14787PB, RP14787PBOAK, RP14787PW, RP14787WC, RP14787WP</b> Lever Handle w/Screw <i>Manija de Palanca con Tornillo</i></p> 	<p><b>RP15552</b> <b>RP15552PB</b> Screw/Tornillo</p>  
<p><b>RP26865</b> Set Screw <i>Tornillo de Ajuste</i></p> 	<p><b>RP6152▲ (Metal/Metálico)</b> <b>RP6218</b> Pulsating Showerhead <i>Cabeza de Regadera Pulsante</i></p> 	<p><b>RP6023▲</b> Shower Arm <i>Brazo de Regadera</i></p>  <p><b>RP6025▲</b> Shower Flange <i>Chapetón de Regadera</i></p> 

See Page 19 for Handle Suffix Chart. Vea la tabla en página 19 para más detalles sobre sufijos de manijas





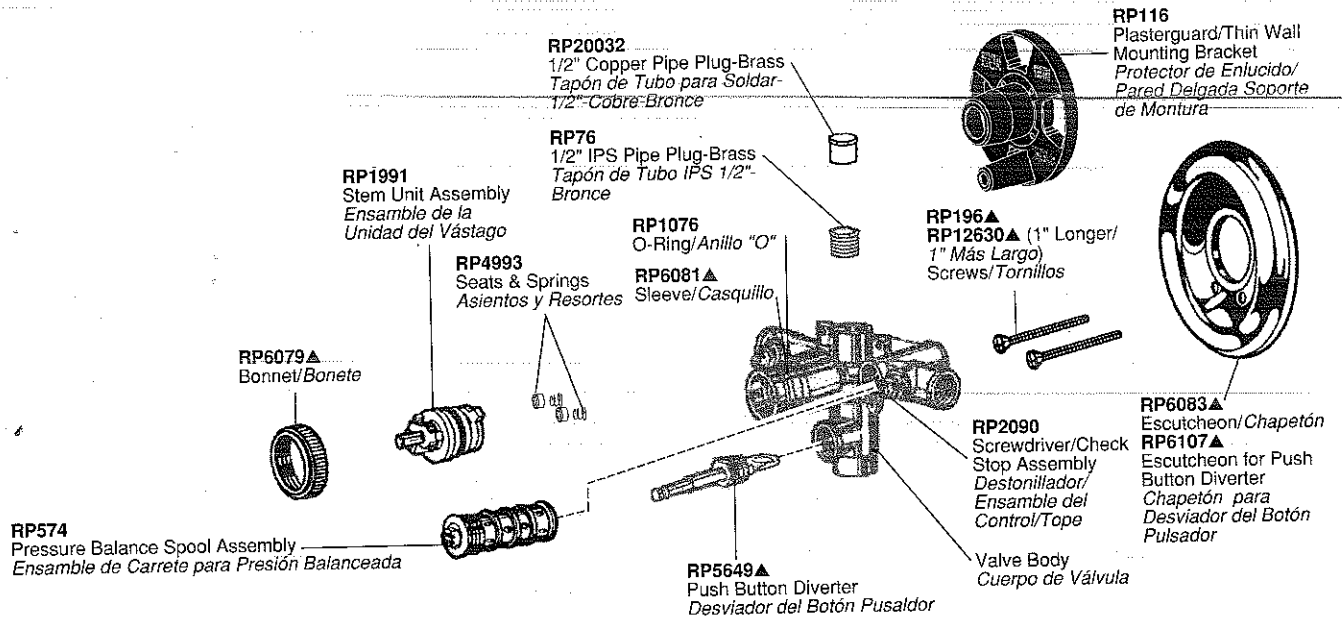

▲ Designate proper finish suffix. Verify available finishes in Miscellaneous Parts Section. **Note:** Chrome models have no finish suffix. AB=Antique Brass, PB=Polished Brass.

▲ *Designe el sufijo apropiado para el acabado. Verifique acabados disponibles en la sección de Piezas Misceláneas. **Nota:** El acabado de los modelos de cromo no tienen sufijo. AB=Bronce Antiguo, PB=Bronce Pulido.*

## Models/Modelos 1600\* Series Pressure Balance Models/Modelos de Presión Balanceada

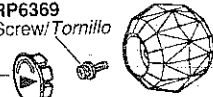

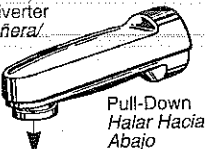
\*Discontinued/Descontinuados

<p><b>RP8655</b> Stainless Steel Liner Repair Kit Herramientas de Acero Inoxidable para Reparaciones de Tuberías</p>	<p><b>RP17160</b> Label-Red/Blue (to be used only on 1600 pressure balance models) Etiqueta-Rojo/Azul (use sólo en modelos 1600 con presión balanceada)</p> 	<p><b>RP2865</b> Push Button Diverter Plug Tapón Desviador con Botón Pulsador</p> 
<p><b>H71, H71PB</b> Handle w/Button &amp; Screw Manija con Botón y Tornillo</p> <p><b>RP20542</b> <b>RP20542PB</b> Button (Red/Blue) Botón (Rojo/Azul)</p> 	<p><b>RP6117</b> Blade Handle w/Screw Palanca de Tipo Aleta con Tornillo</p>  <p><b>RP6119</b> Screw/Tornillo</p> 	<p><b>RP17453</b> <b>RP17454▲</b> (Metal/Metalico) Tub Spout/Pull-Down Diverter Tubo de Salida para Bañera/ Desviador de Halar</p>  <p>Pull-Down Halar Hacia Abajo</p>
<p><b>RP5834</b> <b>RP7533▲</b> (Metal/Metalico) Tub Spout/Pull-Up Diverter Tubo de Salida para Bañera/ Botón Desviador de Alzar</p> 	<p><b>RP5833▲</b> Tub Spout/Non-Diverter (Metal) Tubo de Salida para Bañera/ Sin Desviador (Metalico)</p> 	

# Two Handle Bath Valves

## Válvulas de Dos Manijas para Bañeras

### Models/Modelos 2600 & 2800 Series

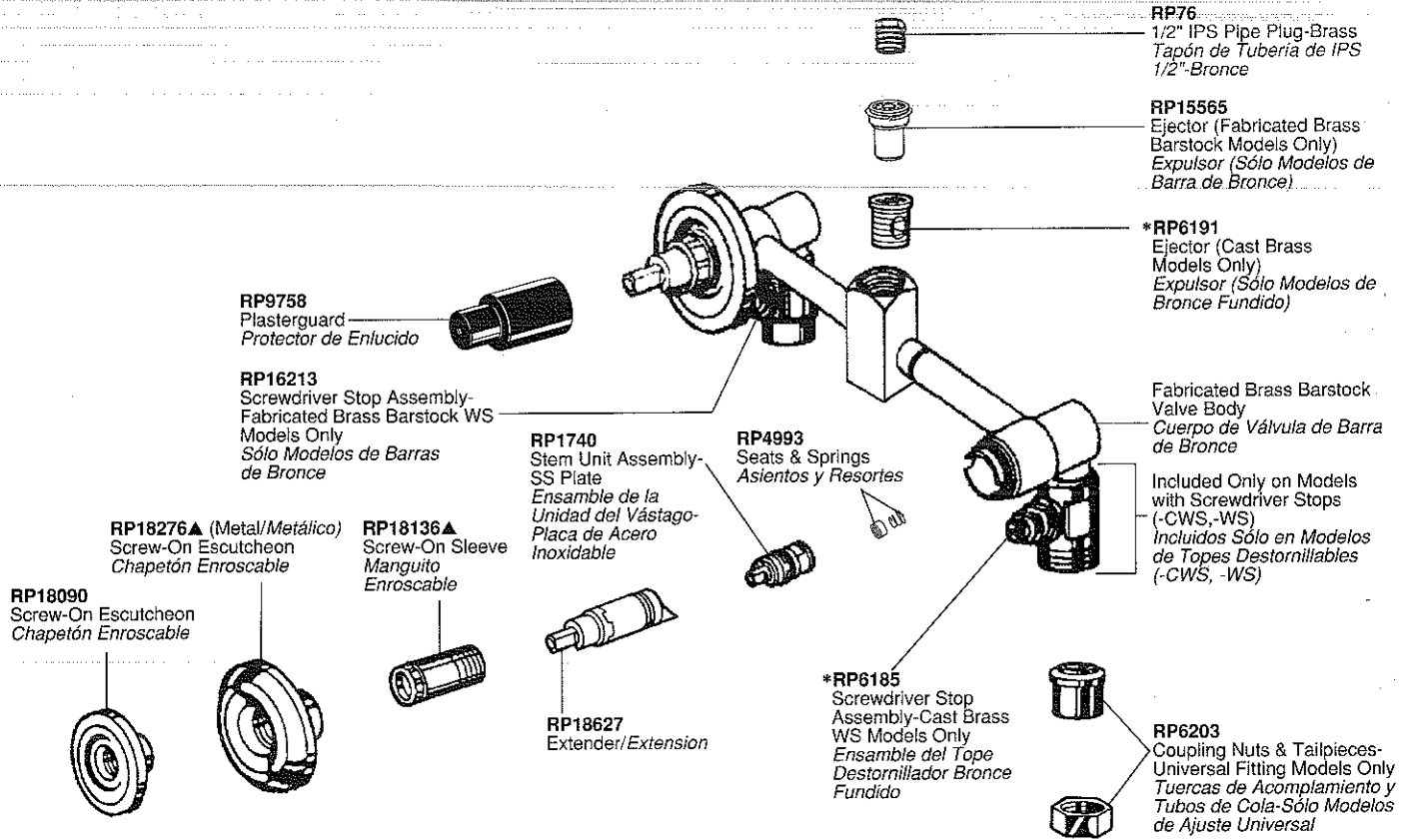

\*Discontinued/Descontinuados

<p><b>RP19156▲ (1" Longer/ 1" Más Largo)</b> Sleeve Extenders Extensiones de Manguitos</p>	<p><b>RP6005</b> Complete Screwdriver Stop- 1/2" CWT Tope Destornillador Completo- 1/2" CWT</p>	<p><b>RP5876</b> Complete Screwdriver Stop- 1/2" IPS Tope Destornillador Completo- 1/2" IPS</p>
<p><b>RP18187</b> <b>RP18724 (Bulk/Cantidades Grandes)</b> Thin Wall Mounting Spacers Separadores para Paredes Delgadas</p>	<p><b>RP5844</b> <b>RP11077 (Bulk/Cantidades Grandes)</b> Thin Wall Shower Arm or Tub Spout Mounting Kit Brazo de Reg.-Paredes Delgadas o Equipo Mont. -Tubo de Bañera</p>	<p><b>RP6124▲</b> Showerhead Adjustable Volume Control Cabeza de Regadera con Control de Volumen</p>
<p><b>RP8655</b> Stainless Steel Liner Repair Kit Herramientas de Acero Inoxidable para Reparaciones de Tuberías</p>	<p><b>RP4239</b> Shower Arm Diverter for Handshower Desviador de Brazo Regadera para Regadera de Mano</p>	<p><b>RP18304▲</b> Screw-On Sleeves &amp; Metal Escutcheons Manguitos Enroscados y Chapetones de Metal</p>

<p><b>RP6122</b> Showerhead Ducha</p>	<p><b>RP6152▲ (Metal/Metálico)</b> <b>RP6218</b> Pulsating Showerhead Cabeza de Regadera Pulsante</p>	<p><b>RP6023▲</b> Shower Arm Brazo de Regadera</p> <p><b>RP6025▲</b> Shower Flange Chapetón de Regadera</p>
<p><b>RP17453</b> <b>RP17454▲ (Metal/Metálico)</b> Tub Spout/Pull-Down Diverter Tubo de Salida para Bañera/ Desviador de Halar</p> <p>Pull-Down Halar Hacia Abajo</p>	<p><b>RP5834</b> <b>RP7533▲ (Metal/Metálico)</b> Tub Spout/Pull-Up Diverter Tubo de Salida para Bañera/ Botón Desviador de Alzar</p>	<p><b>RP5833▲</b> Tub Spout/Non-Diverter (Metal) Tubo de Salida para Bañera/ Sin Desviador (Metálico)</p>

▲ Designate proper finish suffix. Verify available finishes in Miscellaneous Parts Section. **Note:** Chrome models have no finish suffix. AB=Antique Brass, AL=Almond, CB=Chrome/Polished Brass, PB=Polished Brass, WC=White/Chrome, WH=White, WP=White/Polished Brass.

▲ *Designe el sufijo apropiado para el acabado. Verifique acabados disponibles en la sección de Piezas Misceláneas. **Nota:** El acabado de los modelos de cromo no tienen sufijo. AB=Bronce Antiguo, AL=Almendra, CB=Cromo/Bronce Pulido, PB=Bronce Pulido, SB=Bronce Satinado, WC=Blanco/Cromo, WH=Blanco, WP=Blanco/Bronce Pulido.*

## These Screws are Included w/All LHP 2 Handle Tub/Shower Valves and Not with Handle Kits.

*Estos Tornillos están Incluidos con Todas las Válvulas LHP de 2 Manijas para Bañeras/Regaderas y no con los Equipos de Manijas.*

**RP12629**  
Screws (Blade, Knob & Ring Handles)  
*Tornillos (Aleta, Perilla y Anillo)*

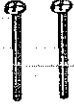

**Use RP12629 w/all handles below**  
*Usa RP12629 con manijas abajo*

---

**H21, H21PB**  
Small Knob Handles w/Buttons  
*Manijas de Perilla Pequeño con Botones*

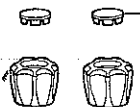

**RP18373, RP18373PB**  
Button Set  
(Red/Blue Indicators)  
*Botones (Indicadores: Rojo/Azul)*

---

**H41, H41PB**  
Medium Knob Handles w/Buttons  
*Manijas de Perilla Mediana con Botones*



**RP18373, RP18373PB**  
Button Set  
(Red/Blue Indicators)  
*Botones (Indicadores: Rojo/Azul)*

---

**H28**  
Blade Handles w/Buttons  
*Manijas de Palanca con Botones*



**RP2412**  
Button Set/Botones

---

**H48**  
Metal Knob Handles w/Buttons  
*Manijas de Perilla Metal con Botones*



**RP19659**  
Button Set (Red/Blue Indicators)  
*Botones (Indicadores: Rojo/Azul)*

---

**H23, H23AB, H23AL, H23PB, H23WH**  
Small Ring Handles w/Caps  
*Manijas de Anillo Pequeña con Casquetes*

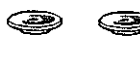

**RP18342, RP18342AB, RP18342AL, RP18342PB, RP18342WH**  
Handle Cap  
*Casquete del Manija*

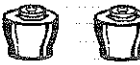

**RP18340, RP18340AB, RP18340AL, RP18340PB, RP18340WH**  
Handle Base/Base de Manija

---

**A23, A23AB, A23AL, A23OK, A23PB, A23ST, A23WH**  
Handle Accents/Acentos para Manijas



**RP20184**  
Retention Screws (Side Mount Cross & Lever Handles)  
*Tornillos de Retención (Cruz de Montura de Lado y Palancas)*



**Use RP20184 w/all handles below**  
*Usa RP20184 con manijas abajo*

---

**H22, H22AB, H22AL, H22PB, H22WH**  
Small Lever Handles w/Screws  
*Manijas de Pequeña de Palanca con Tornillos*



**RP25620**  
Set Screws  
*Tornillos de Ajuste*

---

**A22, A22AB, A22AL, A22CL, A22OK, A22PB, A22PR, A22RS, A22WH, A22WW**  
Handle Accents/Acentos para Manijas



---

**H24, H24AL, H24PB, H24WH**  
Small Lever Handles w/Screws  
*Manijas Pequeña de Palanca con Tornillos*



**RP25620**  
Set Screws  
*Tornillos de Ajuste*

---

**A24, A24AL, A24CL, A24PB, A24WH**  
Handle Accents  
*Acentos para Manijas*

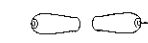

---

**H25, H25AC, H25AP, H25CA, H25CB, H25CK, H25CW, H25PA, H25PB, H25PK, H25PW, H25WC, H25WP**  
Small Lever Handles w/Screws  
*Manijas de Pequeña de Palanca con Tornillos*



**RP25620**  
Set Screws  
*Tornillos de Ajuste*

---

**H46, H46AC, H46AP, H46CB, H46PB, H46WC, H46WP**  
Medium Metal Cross Handles w/Screws  
*Manijas de Cruz de Metal Mediana con Tornillos*



**RP25620**  
Set Screws  
*Tornillos de Ajuste*

---

**H27, H27PB**  
Small Porcelain Cross Handles w/Screws  
*Manijas de Cruz Pequeña de Porcelana con Tornillos*



**RP25620**  
Set Screws  
*Tornillos de Ajuste*

**RP12574**  
Screws-Vandal Resistant (Wrist Blade & Top Mounted Handles)  
*Tornillos Resistentes al Maltrato (Aletas y Manijas de Montura Superior)*



---

**RP12630, RP12630AL, RP12630PB, RP12630SB, RP12630WH**  
Screws (Wrist Blade & Top Mount Lever Handles)  
*Tornillos (Aletas y Palancas de Montura Superior)*

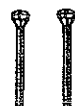







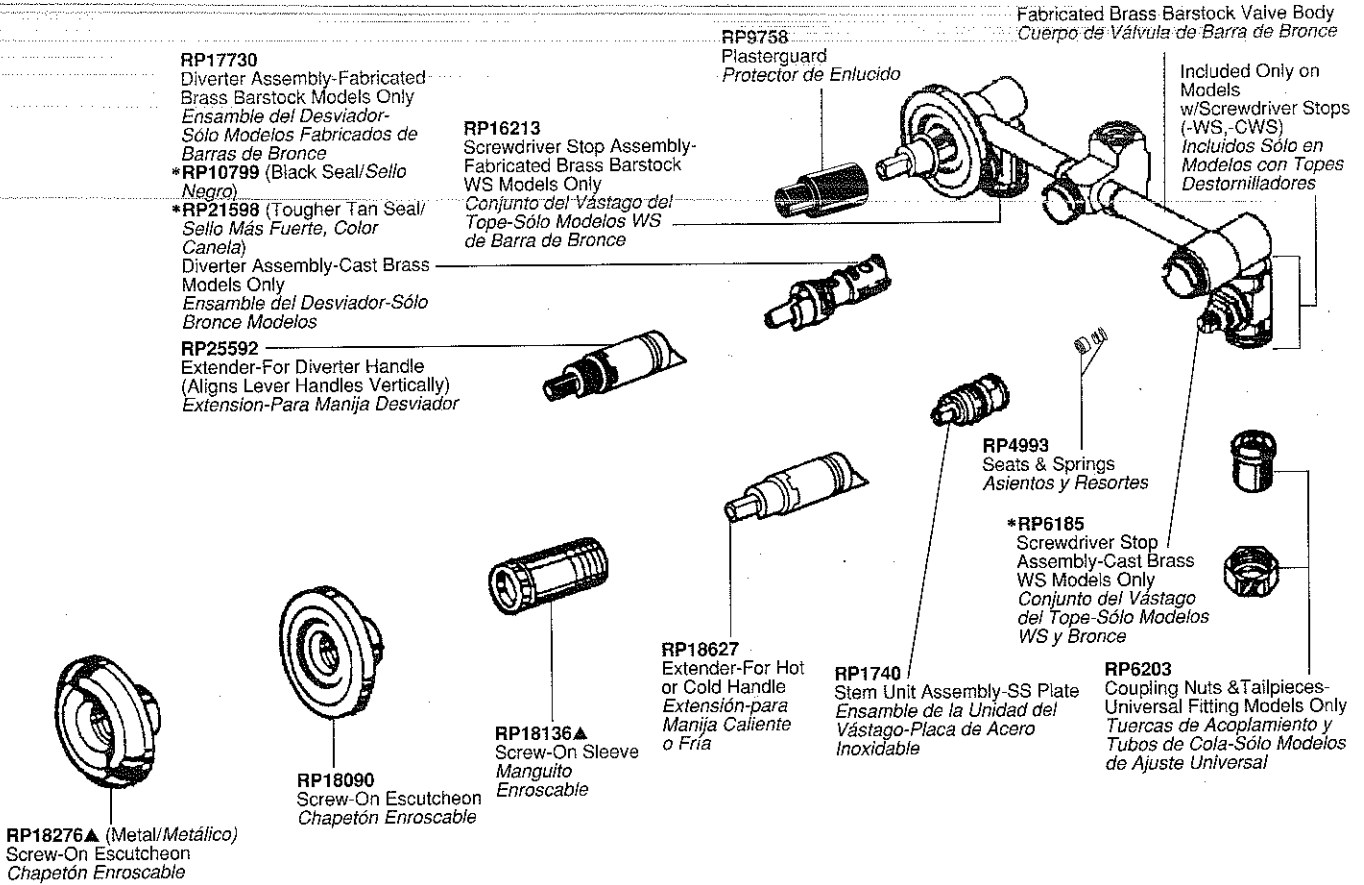

# Three Handle Bath Valves

## Válvulas de Bañeras de Tres Manijas

Models/Modelos 2653, 2683, 2885, 2897 Series

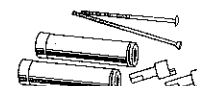
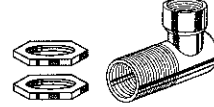
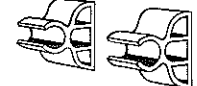

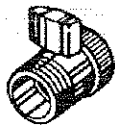
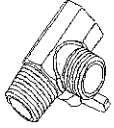
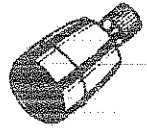
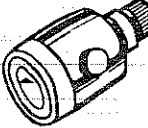
\*Discontinued/Descontinuados

	<p><b>RP18312▲</b> Screw-On Sleeves &amp; Metal Escutcheons Manguitos Deslice y Chapetones de Metálico</p> 	<p><b>RP8655</b> Stainless Steel Liner Repair Kit Herramientas de Acero Inoxidable para Reparaciones de Tuberías</p>
<p><b>RP19156▲</b> (1" Longer/ 1" Más Largo) Screw-On Sleeve Extenders Extensiones de Manguitos Deslice</p> 	<p><b>RP5844</b> <b>RP11077</b> (Bulk/Cantidades Grandes) Thin Wall Shower Arm or Tub Spout Mounting Kit Brazo de Regadera para Paredes Delgadas o Herramientas para la Montura del Tubo de Bañera</p> 	<p><b>RP18187</b> <b>RP19724</b> (Bulk/Cantidades Grandes) Thin Wall Mounting Spacers Separadores para Paredes Delgadas*</p> 
<p><b>RP5833▲</b> Tub Spout/Non-Diverter (Metal) Tubo de Salida para Bañera/Sin Desviador (Metálico)</p> 	<p><b>RP6124▲</b> Showerhead Adjustable Volume Control Cabeza de Regadera con Control de Volumen</p> 	<p><b>RP4239</b> Shower Arm Diverter for Hand Shower Desviador de Brazo Regadera para Regadera de Mano</p> 
<p><b>RP6122</b> Showerhead Ducha</p> 	<p><b>RP6152▲</b> (Metal/Metálico) <b>RP6218</b> Pulsating Showerhead Cabeza de Regadera Pulsante</p> 	<p><b>RP6023▲</b> Shower Arm Brazo de Regadera</p>   <p><b>RP6025▲</b> Shower Flange Chapetón de Regadera</p> 

▲ Designate proper finish suffix. Verify available finishes in Miscellaneous Parts Section. **Note:** Chrome models have no finish suffix. CB=Chrome/Polished Brass, PB=Polished Brass, WC=White/Chrome, WH=White, WP=White/Polished Brass.







▲ *Designe el sufijo apropiado para el acabado. Verifique acabados disponibles en la sección de Piezas Misceláneas. **Nota:** El acabado de los modelos de cromo no tienen sufijo. CB=Cromo/Bronce Pulido, PB=Bronce Pulido, WC=Blanco/Cromo, WH=Blanco, WP=Blanco/Bronce Pulido.*





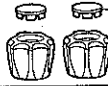

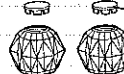
**These Screws are Included w/All LHP 3 Handle Tub/Shower Valves and Not with Handle Kits.**  
*Estos Tornillos están Incluidos con Todas las Válvulas de 3 Manijas LHP para Bañeras y Regaderas y no con Equipos de Manijas.*

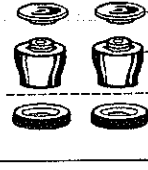
<p><b>RP12629</b> Screws (Blade, Knob &amp; Ring Handles) <i>Tornillos (Manijas de Aletas, Perillas y Anillos)</i></p> 	<p><b>RP12630, RP12630AL, RP12630PB, RP12630SB, RP12630WH, RP12574 (VR)</b> Screws (Wrist Blade &amp; Top Mount Lever Handles) <i>Tornillos (Aletas y Palancas de Montura Superior)</i></p> 	<p><b>RP20184</b> Retention Screws (Side Mount Cross &amp; Lever Handles) <i>Tornillos de Retención (Cruz de Montura de Lado y Palancas)</i></p> 
--	---	--

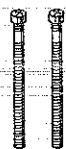
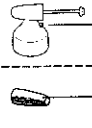
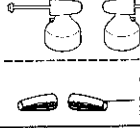
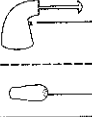
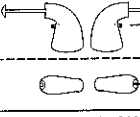
**Diverter Handles**  
*Manijas de Desviador*

**Hot and Cold Handles**  
*Manijas de Caliente y Fria*

<p><b>Use RP12629 Screws w/these handles.</b> <i>Usa Tornillos de RP12629 con estas manijas.</i></p> 	<p><b>H11, H11PB</b> Small Knob Handle w/Hot, Cold &amp; Arrow Buttons <i>Manija de Perilla Pequeño con Botones de Caliente, Fria y Flecha</i></p> <p><b>RP18373, RP18373PB</b> Hot/Cold Button Set (Red/Blue Indicators) <i>Botones de Caliente/Fria (Indicadores: Rojo/Azul)</i> <b>RP18429, RP18429PB</b> Arrow Button/Botón de Flecha</p> 	<p><b>H21, H21PB</b> Small Knob Handles w/Buttons <i>Manijas de Perilla Pequeño con Botones</i></p> <p><b>RP18373, RP18373PB</b> Button Set (Red/Blue Indicators) <i>Botones (Indicadores: Rojo/Azul)</i></p> 
	<p><b>H31, H31PB</b> Medium Knob Handle w/Button <i>Manija de Perilla Mediana con Botón</i></p> <p><b>RP18429, RP18429PB</b> Button-Arrow/Botón-Flecha</p> 	<p><b>H41, H41PB</b> Medium Knob Handles w/Buttons <i>Manijas de Perilla Mediana con Botones</i></p> <p><b>RP18373, RP18373PB</b> Button Set (Red/Blue Indicators) <i>Botones (Indicadores: Rojo/Azul)</i></p> 
	<p><b>H13, H13PB, H13WH</b> Small Ring Handle w/Cap <i>Manija de Anillo Pequeña con Casquete</i></p> <p><b>RP18342, RP18342PB, RP18342WH</b> Handle Cap/Casquete del Manija <b>RP18340, RP18340PB, RP18340WH</b> Handle Base/Base de la Manija</p> <p><b>A13, A13AB, A13AL, A13OK, A13PB, A13ST, A13WH</b> Handle Accent/Acento para Manija</p> 	<p><b>H23, H23PB, H23WH</b> Small Ring Handles w/Caps <i>Manijas de Anillo Pequeña con Casquetes</i></p> <p><b>RP18342, RP18342PB, RP18342WH</b> Handle Cap/Casquete del Manija <b>RP18340, RP18340PB, RP18340WH</b> Handle Base/Base de la Manija</p> <p><b>A23, A23AB, A23AL, A23OK, A23PB, A23ST, A23WH</b> Handle Accents/Acentos para Manijas</p> 

<p><b>Use RP20184 Retention Screws w/these handles.</b> <i>Usa Tornillos de Retención de RP20184 con estas manijas.</i></p> 	<p><b>H12, H12PB, H12WH</b> Small Lever Handle w/Screw <i>Palanca Pequeña con Tornillo</i></p> <p><b>RP25620</b> Set Screw/Tornillo de Ajuste</p> <p><b>A12, A12AB, A12AL, A12CL, A12OK, A12PB, A12PR, A12RS, A12WH, A12WW</b> Handle Accent/Acento para Manija</p> 	<p><b>H22, H22PB, H22WH</b> Small Lever Handles w/Screws <i>Palancas Pequeñas con Tornillos</i></p> <p><b>RP25620</b> Set Screws/Tornillos de Ajuste</p> <p><b>A22, A22AB, A12AL, A22CL, A22OK, A22PB, A22PR, A22RS, A22WH, A22WW</b> Handle Accents/Acentos para Manijas</p> 
	<p><b>H14, H14PB, H14WH</b> Small Lever Handle w/Screw/Palanca Pequeña con Tornillo</p> <p><b>RP25620</b> Set Screw/Tornillo de Ajuste</p> <p><b>A14, A14AL, A14CL, A14PB, A14WH</b> Handle Accent/Acento para Manija</p> 	<p><b>H24, H24PB, H24WH</b> Small Lever Handles w/Screws <i>Palancas Pequeñas con Tornillos</i></p> <p><b>RP25620</b> Set Screws/Tornillos de Ajuste</p> <p><b>A24, A24AL, A24CL, A24PB, A24WH</b> Handle Accents/Acentos para Manijas</p> 
	<p><b>H15, H15CA, H15CB, H15CK, H15CW, H15PA, H15PB, H15PK, H15PW, H15WC, H15WP</b> Small Lever Handle w/Screw/Palanca Pequeña con Tornillo</p> <p><b>RP25620</b> Set Screw/Tornillo de Ajuste</p> 	<p><b>H25, H25CA, H25CB, H25CK, H25CW, H25PA, H25PB, H25PK, H25PW, H25WC, H25WP</b> Small Lever Handles w/Screws <i>Palancas Pequeñas con Tornillos</i></p> <p><b>RP25620</b> Set Screws/Tornillos de Ajuste</p> 
	<p><b>H17, H17PB</b> Small Porcelain Cross Handle w/Screw <i>Manija de Cruz Pequeño de Porcelana con Tornillo</i></p> <p><b>RP25620</b> Set Screw/Tornillo de Ajuste</p> 	<p><b>H27, H27PB</b> Small Porcelain Cross Handles w/Screws <i>Manijas de Cruz Pequeño de Porcelana con Tornillos</i></p> <p><b>RP25620</b> Set Screws/Tornillos de Ajuste</p> 
	<p><b>H36, H36CB, H36PB, H36WC, H36WP</b> Medium Metal Cross Handle w/Screw <i>Manija de Cruz de Metal Mediana con Tornillo</i></p> <p><b>RP25620</b> Set Screw/Tornillo de Ajuste</p> 	<p><b>H46, H46CB, H46PB, H46WC, H46WP</b> Medium Metal Cross Handles w/Screws <i>Manijas de Cruz de Metal Mediana con Tornillos</i></p> <p><b>RP25620</b> Set Screws/Tornillos de Ajuste</p> 

See Page 19 for Handle Suffix Chart/ *Vea la tabla en página 19 para más detalles sobre sufijos de manijas*

# Two Handle Bath Valves/Hand Showers/Accessories Válvulas de Dos Manijas/Regaderas de Mano/Accesorios

Models/Modelos 2702\* & 2746\* Series  
Fiberglass or Flexible Mount/Vidrio Fibroso o de Montura Flexible

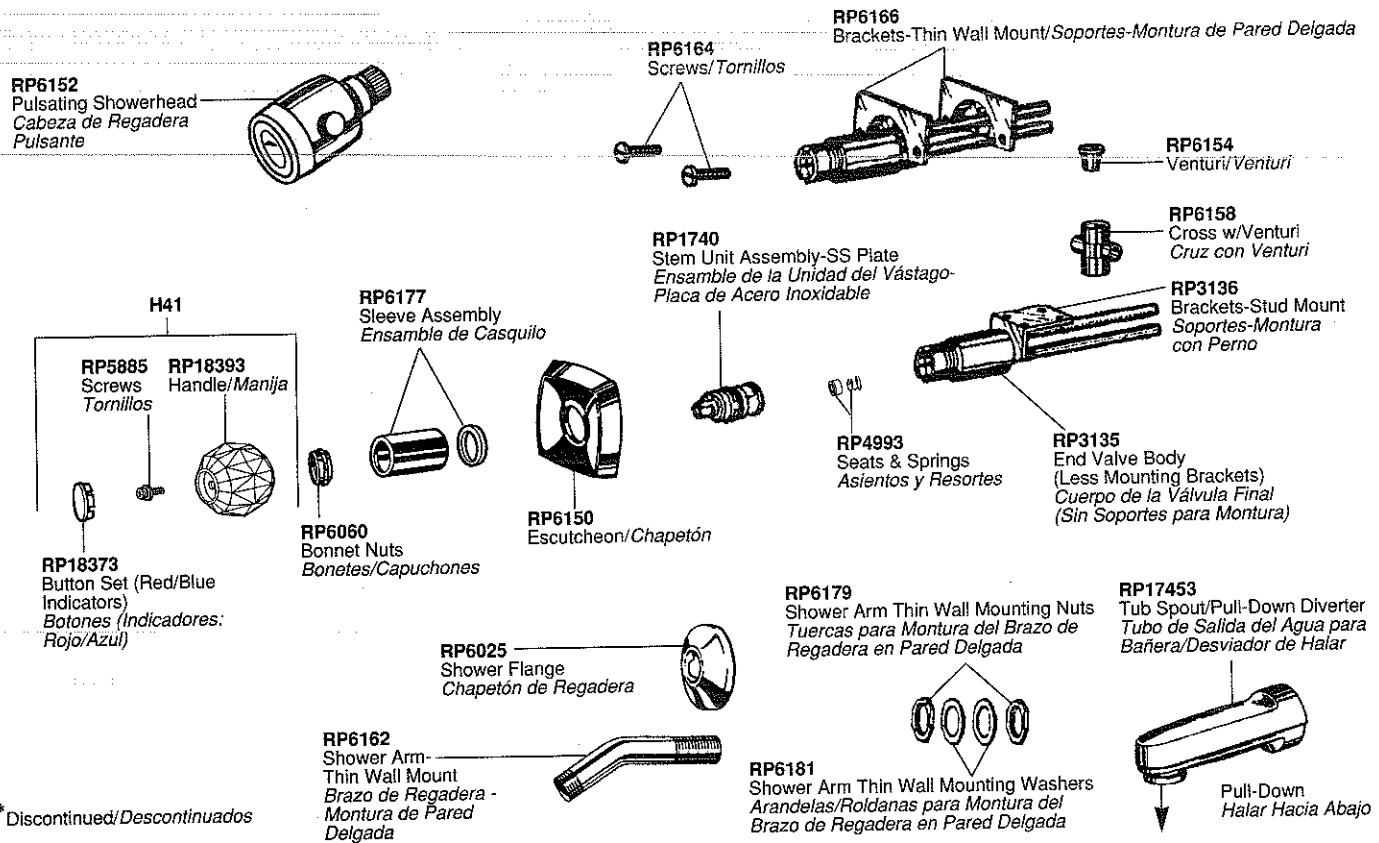

## Models/Modelos RP7245, RPW1111HDF & RPW2222HDF Series Hand Showers & Accessories/Regaderas de Mano y Accesorios

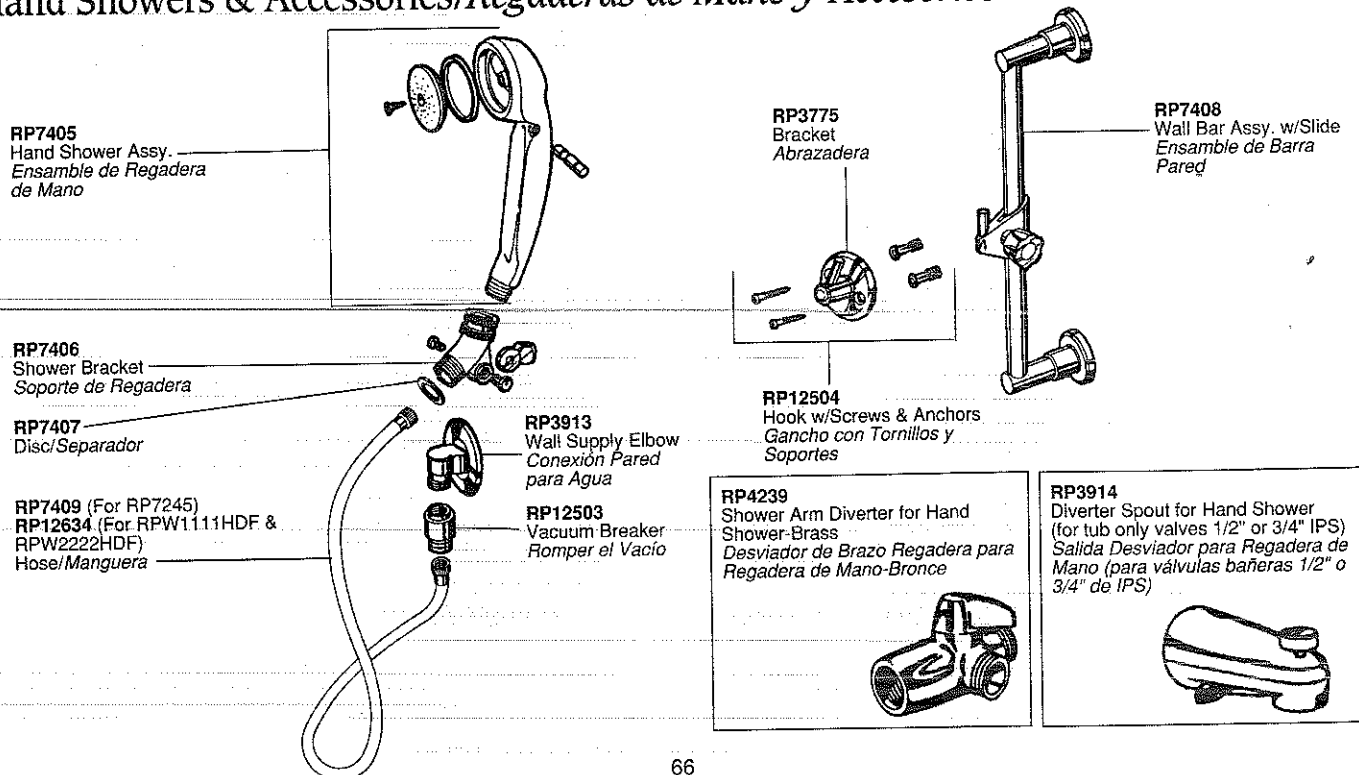

▲ Designate proper finish suffix. Verify available finishes in Miscellaneous Parts Section. **Note:** Chrome models have no finish suffix. AB=Antique Brass, AC=Almond/Chrome, AL=Almond, CB=Chrome/Polished Brass, PB=Polished Brass, WC=White/Chrome, WH=White, WP=White/Polished Brass.

▲ *Designe el sufijo apropiado para el acabado. Verifique acabados disponibles en la sección de Piezas Misceláneas. Nota: El acabado de los modelos de cromo no tienen sufijo. AB=Bronce Antiguo, AC=Almendra/Cromo, AL=Almendra, CB=Cromo/Bronce Pulido, PB=Bronce Pulido, WC=Blanco/Cromo, WH=Blanco, WP=Blanco/Bronce Pulido.*

## Tub & Shower Accessories Accesorios de Bañeras y Regaderas

**RP6122**  
Standard Self-Cleaning  
Limpieza de Mismo

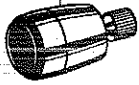

**RP6212**  
Adjustable Volume Control  
Control Volumen

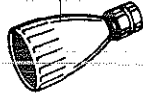

**RP25528▲**  
Touch-Clean™  
Touch-Clean™

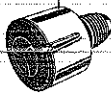

**RP65▲**  
The Embracer®  
The Embracer®

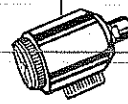

**RPW33HDF**  
Adjustable Volume Control-VR  
Control Volumen-VR

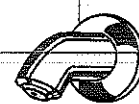

**RPW66HDF**  
Showerhead-VR  
Ducha-Resistente  
al Maltrato

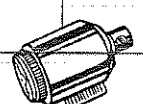

**RP12086**  
Replacement Flow Limiter  
Limitar de Flujo



For Pulsating Showerheads  
Para Cabezas de Regaderas Pulsante

**RP6152▲** (Metal/Metalico)  
Pulsating  
Pulsante

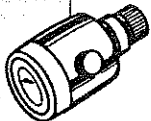

**RP6218**  
Pulsating  
Pulsante

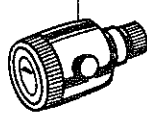

**RP3924**  
Repair Kit  
Equipo para Reparaciones

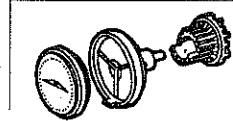

**RP20605**  
**RP20605SB** (for antique & polished brass/para bronce antiguo y pulido)  
Handle w/O-Ring  
Manija con Anillo "O"



**RP13498**  
Spanner Wrench for RPW66HDF  
Llave de Gancho para RPW66HDF

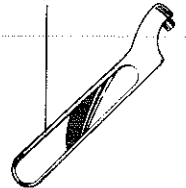

**RP17453**  
**RP17454▲** (Metal/Metalico)  
Pull-Down Diverter  
Desviador de Halar

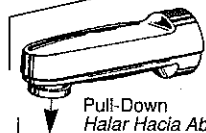

Pull-Down  
Halar Hacia Abajo



**RP5836**  
**RP19581PB** (Metal/Metalico)  
Slip-On Pull-Down Diverter  
Desviador de Halar

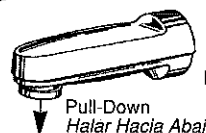

Pull-Down  
Halar Hacia Abajo

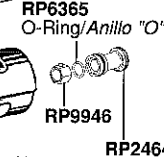

RP24649

**RP5834**  
**RP7533▲** (Metal/Metalico)  
Pull-Up Diverter  
Botón Desviador de Alzar

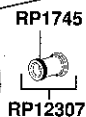

**RP19820**  
Slip-On Pull-Up Diverter  
Botón Desviador de Alzar

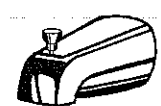

**RP17829**  
Wall Decal - Pull-Down Diverter Spout Operation  
Etiqueta para Pared-Funcionamiento de Salida Desviador de Halar  
**RP17472**  
Decal - Removable Pull-Down Tub Spout Operation  
Etiqueta-Funcionamiento de Salida de Halar

**RP12487, RP12487PB, RP12487SB** (for antique brass/para bronce antiguo)  
Diverter Assy. / Ensamble del Desviador



**RP5833▲**  
Over-the-Rim  
Sin Desviador



**RP5835**  
Slip-On OTR  
Sin Desviador Deslice



**RP18396▲**  
Wall Mount Roman Tub Slip-On Spout  
Tubo de Salida Deslice para Pared  
Montura de Bañera Romana

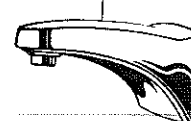

**RP17353▲**  
C-Spout  
Tubo de Salida en forma de "C"



**RP11710▲**  
Shower Arm  
Brazo de Regadera

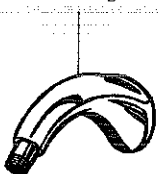

**RPW650HDF**  
Arm & Flange-VR  
Brazo de Regadera  
y-Brida-VR



**RP6023▲**  
Shower Arm  
Brazo de Regadera

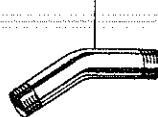

**RP6025▲**  
Flange  
Brida



**RP6162**  
Shower Arm-Thin  
Wall Mount  
Brazo de Regadera-  
Montura de Pared Delgada

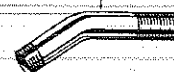

**RP6179**  
Nuts/Tuercas



**RP6181**  
Washers/Arandelas



**RP6124▲**  
Adjustable Volume Control  
Control Volumen

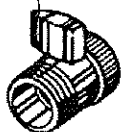

# Deck/Ledge Mount Tub Fillers/Roman Tub Faucets

## Tubos de Salida de Agua para Montar en Bordos de Bañeras/Llaves para Bañeras Romanas

Models/Modelos 2708 & 2750 Series

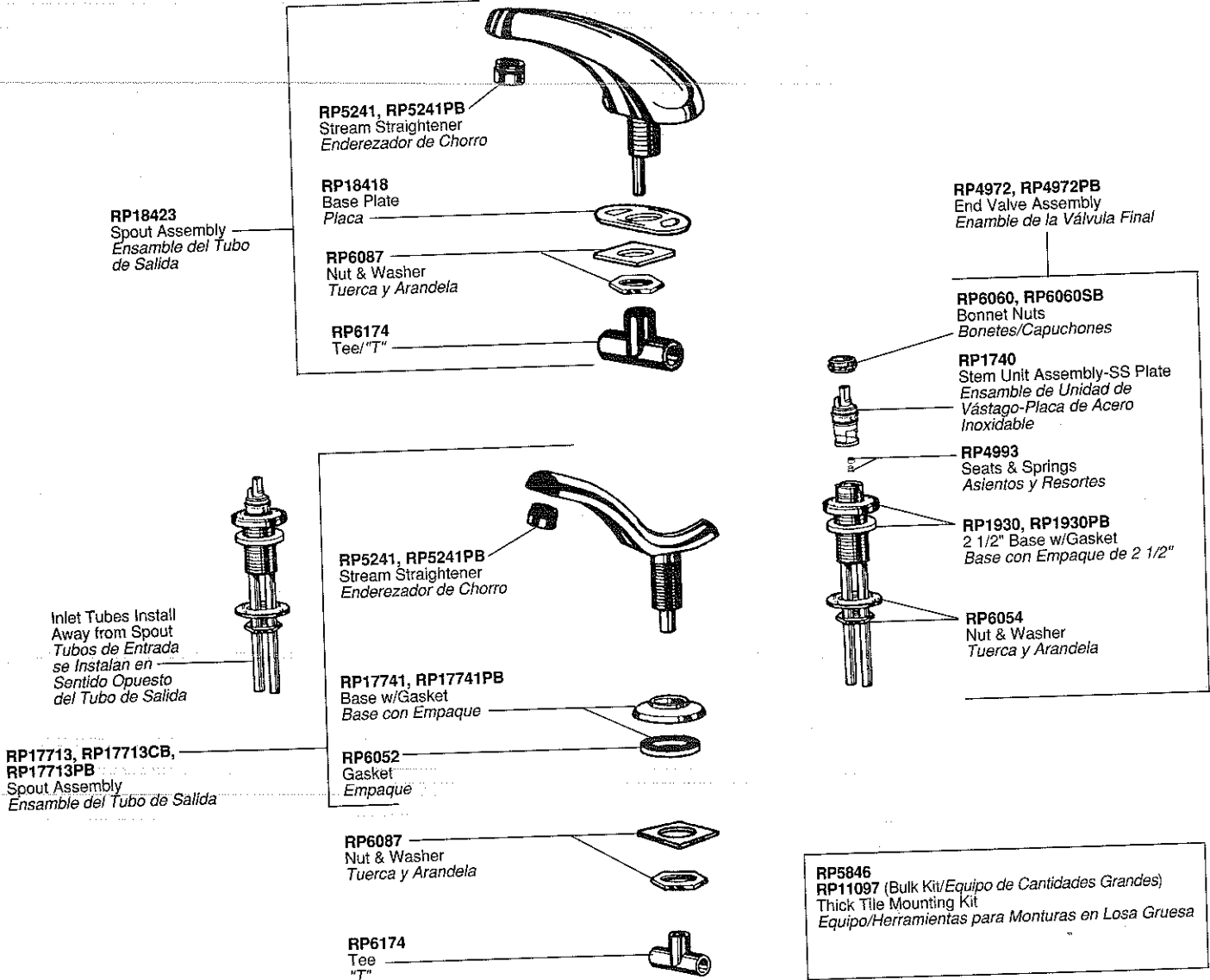

<p><b>H41, H41PB</b> (2708 Only/Sólo 2708) Medium Knob Handles w/Buttons &amp; Screws Manijas de Perilla Mediana con Botones y Tornillos</p> <p><b>RP18373, RP18373PB</b> Button Set (Red/Blue Indicators) Botones (Indicadores: Rojo/Azul)</p> <p><b>RP5885</b> Screws/Tornillos</p>	<p><b>H67, H67PB</b> Large Porcelain Cross Handles w/Screws Manijas de Cruz Pequeño de Porcelana con Tornillos</p> <p><b>RP26865</b> Set Screws Tornillos de Ajuste</p> <p><b>RP20185</b> Retention Screws Tornillos de Retención</p>	<p><b>H66, H66AC, H66AP, H66CB, H66PB, H66WC, H66WP</b> Large Metal Cross Handles w/Set Screws Manijas de Cruz de Metal Mediana con Tornillos de Presión</p> <p><b>RP26865</b> Set Screws Tornillos de Ajuste</p> <p><b>RP20185</b> Retention Screws Tornillos de Retención</p>
<p><b>H48</b> Metal Knob Handles w/Buttons &amp; Screws Manijas de Perilla Metal con Botones y Tornillos</p> <p><b>RP19659</b> Button Set (Red/Blue Indicators) Botones (Indicadores: Rojo/Azul)</p> <p><b>RP5885</b> Screws/Tornillos</p>	<p><b>H61, H61PB</b> (2750, Roman Tub Only) Large Knob Handles w/Buttons &amp; Screws Manijas de Perilla Grande con Botones y Tornillos</p> <p><b>RP18373, RP18373PB</b> Button Set (Red/Blue Indicators) Botones (Indicadores: Rojo/Azul)</p> <p><b>RP5885</b> Screws/Tornillos</p>	<p><b>H65, H65AC, H65AP, H65CA, H65CB, H65CK, H65CW, H65PA, H65PB, H65PK, H65PW, H65WC, H65WP</b> Large Lever Handles w/Screws Manijas de Grande de Palanca</p> <p><b>RP26865</b> Set Screws/Tornillos de Ajuste</p> <p><b>RP20185</b> Retention Screws Tornillos de Retención</p>

See Page 19 for Handle Suffix Chart/Vea la tabla en página 19 para más detalles sobre sufijos de manijas

▲ Designate proper finish suffix. Verify available finishes in Miscellaneous Parts Section. **Note:** Chrome models have no finish suffix. AB=Antique Brass, AL=Almond, CB=Chrome/Polished Brass, PB=Polished Brass, WH=White.

▲ Designe el sufijo apropiado para el acabado. Verifique acabados disponibles en la sección de Piezas Misceláneas. **Nota:** El acabado de modelos de cromo no tienen sufijo. AB=Bronce Antiguo, AL=Almendra, CB=Cromo/Bronce, PB=Bronce Pulido, WH=Blanco.

## Models/Modelos 2710 & 2711 Series

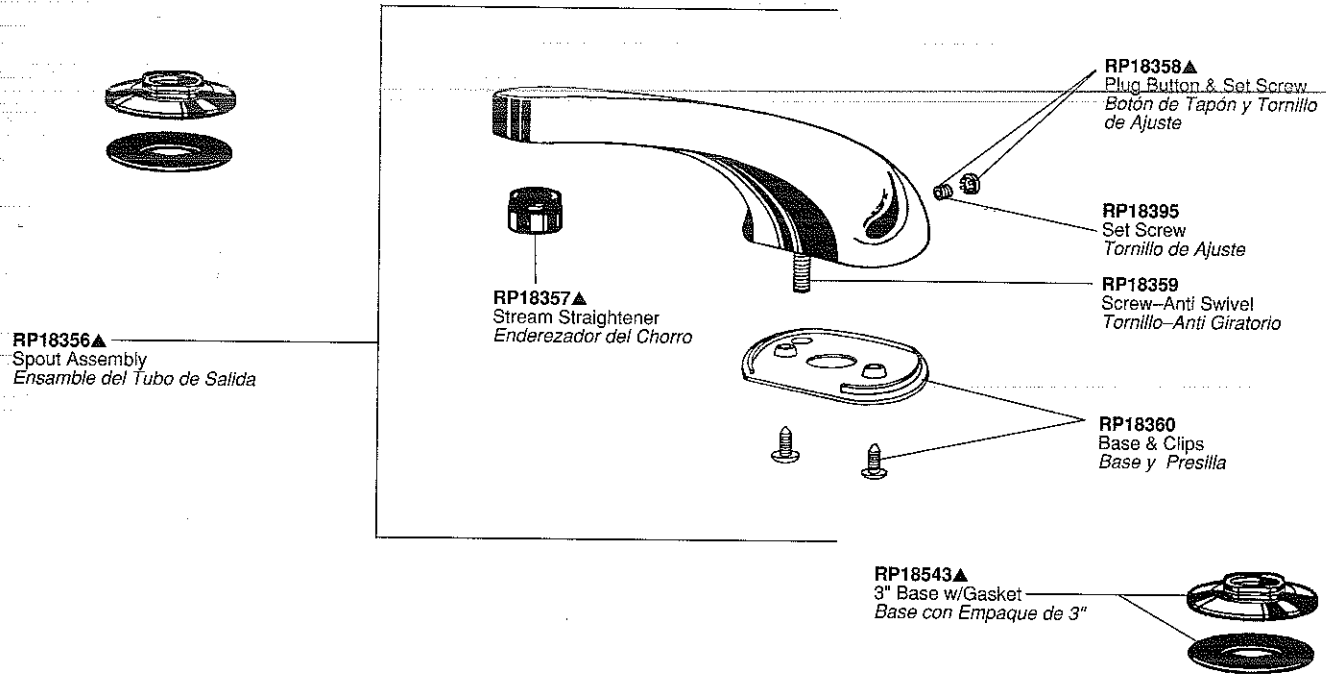

2710 Series includes Conventional Rough-In Kit RP18227. See Page 74.  
La Serie 2710 incluye equipo para preparación de instalación convencional RP18227. Vea página 74.

2711 Series includes Trim Only. Refer to Pages 74 & 75 for Rough-In Kit options.  
La Serie 2711 Sólo incluye la guarnición. Vea páginas 74 y 75 con opciones a para la preparación de instalación.

### OPTIONAL/OPCIONAL

**RP18300▲**  
2 1/2" Base w/Gasket  
Base con Empaque de 2 1/2"  
For Use w/Conventional  
Rough-In Kits Only  
Sólo Para Uso con Equipo de  
Preparación para Instalación  
Convencional

**H62, H62AB, H62AL, H62PB, H62WH**  
Large Lever Handles w/Screws  
Manijas Grande de Palanca con Tornillos

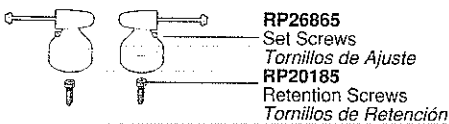

**H64, H64AL, H64PB, H64WH**  
Large Lever Handles w/Screws  
Manijas Grande de Palanca con Tornillos

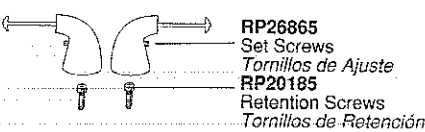

**H63, H63AB, H63AL, H63PB, H63WH**  
Large Ring Handles w/Caps & Screws  
Manijas de Anillo Grande con Casquetes y Tornillos

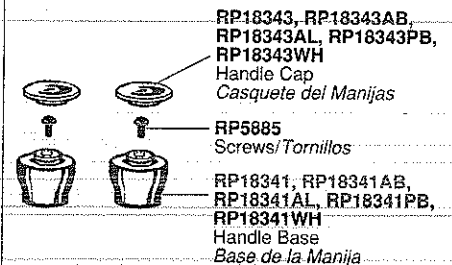

**A62, A62AB, A62AL, A62CL, A62OK, A62PB, A62PR, A62RS, A62WH, A62WW**  
Handle Accents/Acentos para Manijas

**A64, A64AL, A64CL, A64PB, A64WH**  
Handle Accents/Acentos para Manijas

**A63, A63AB, A63AL, A63OK, A63PB, A63ST, A63WH**  
Handle Accents/Acentos para Manijas

See Page 19 for Handle Suffix Chart/Vea la tabla en página 19 para más detalles sobre sufijos de manijas

# Deck/Ledge Mount Roman Tub Faucets

## Llaves para Montar en Bordos de Bañeras Romanas

Models/Modelos 2730 & 2731 Series

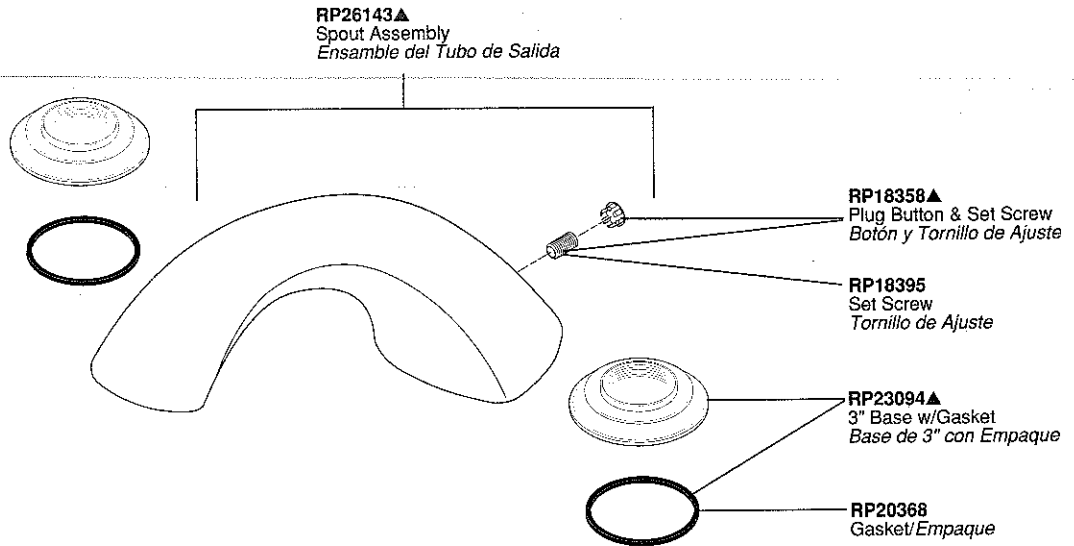

2730 Series includes Conventional Rough-In Kit RP18227. See Page 74.

La Serie 2730 incluye equipo para preparación de instalación convencional RP18227. Vea página 74.

2731 Series includes Trim Only. Refer to Pages 74 & 75 for Rough-In Kit options.

La Serie 2731 sólo incluye la guarnición. Vea páginas 74 y 75 con opciones a para la preparación de instalación.

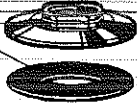
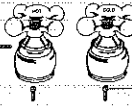
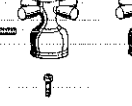
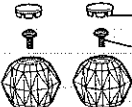
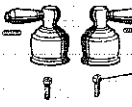
<p><b>OPTIONAL/OPCIONAL</b></p> <p><b>RP18300▲</b> 2 1/2" Base w/Gasket Base con Empaque de 2 1/2"</p> <p>For Use w/Conventional Rough-In Kits Only Uso Sólo con Equipo para Preparación de Instalación Convencional</p> 	<p><b>H67, H67PB</b> Large Porcelain Cross Handles w/Screws Manijas de Cruz Pequeño de Porcelana con Tornillos</p>  <p><b>RP26865</b> Set Screws Tornillos de Ajuste</p> <p><b>RP20185</b> Retention Screws Tornillos de Retención</p>	<p><b>H66, H66AC, H66AP, H66CB, H66PB, H66WC, H66WP</b> Large Metal Cross Handles w/Set Screws Manijas de Cruz de Metal Mediana con Tornillos de Presión</p>  <p><b>RP26865</b> Set Screws Tornillos de Ajuste</p> <p><b>RP20185</b> Retention Screws Tornillos de Retención</p>
<p><b>H61, H61PB</b> Large Knob Handles w/Buttons &amp; Screws Manijas de Perilla Grande con Botones y Tornillos</p>  <p><b>RP18373, RP18373PB</b> Button Set (Red/Blue Indicators) Botones (Indicadores: Rojo/Azul)</p> <p><b>RP5885</b> Screws/Tornillos</p>	<p><b>H65, H65AC, H65AP, H65CA, H65CB, H65CK, H65CW, H65PA, H65PB, H65PK, H65PW, H65WC, H65WP</b> Large Lever Handles w/Screws Manijas de Grande de Palanca</p>  <p><b>RP26865</b> Set Screws/Tornillos de Ajuste</p> <p><b>RP20185</b> Retention Screws Tornillos de Retención</p>	

See Page 19 for Handle Suffix Chart/Vea la tabla en página 19 para más detalles sobre sufijos de manijas

▲ Designate proper finish suffix. Verify available finishes in Miscellaneous Parts Section. **Note:** Chrome models have no finish suffix: AC=Almond/Chrome, AL=Almond, AP=Almond/Polished Brass, CB=Chrome/Polished Brass, PB=Polished Brass, WC=White/Chrome, WH=White, WP=White/Polished Brass.



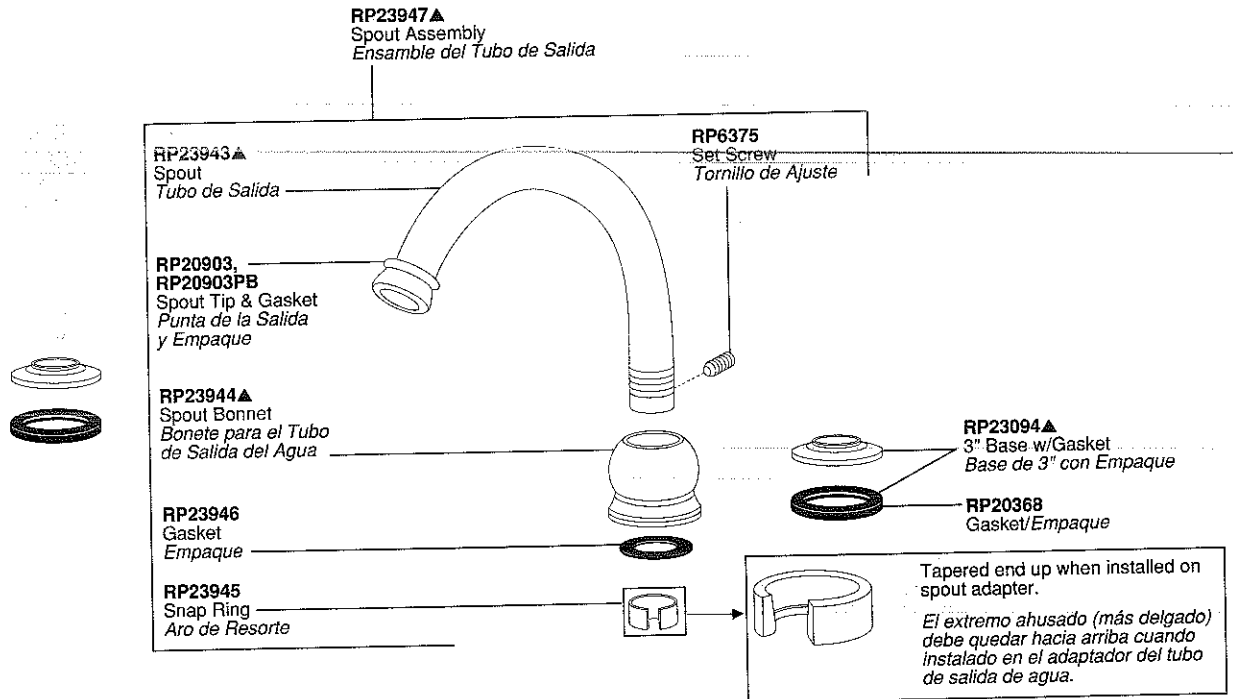

▲ Designe el sufijo apropiado para el acabado. Verifique acabados disponibles en la sección de Piezas Misceláneas. **Nota:** El acabado de los modelos de cromo no tienen sufijo. AC=Almendra/Cromo, AL=Almendra, AP=Almendra/Bronce Pulido, CB=Cromo/Bronce Pulido, PB=Bronce Pulido, WC=Blanco/Cromo, WH=Blanco, WP=Blanco/Bronce Pulido.

## Models/Modelos 2767 & 2768 Series

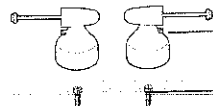
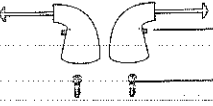
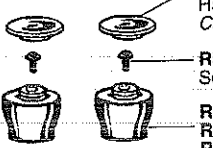

2767 Series includes Conventional Rough-In Kit RP18227. See Page 74.  
La Serie 2767 incluye equipo para preparación de instalación convencional RP18227. Vea página 74.

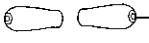
2768 Series includes Trim Only. Refer to Pages 74 & 75 for Rough-In Kit options.  
La Serie 2768 sólo incluye la guarnición. Vea páginas 74 y 75 con opciones a para la preparación de instalación.

<b>H62, H62AB, H62AL, H62PB, H62WH</b> Large Lever Handles w/Screws Manijas Grande de Palanca con Tornillos	<b>H64, H64AL, H64PB, H64WH</b> Large Lever Handles w/Screws Manijas Grande de Palanca con Tornillos	<b>H63, H63AB, H63AL, H63PB, H63WH</b> Large Ring Handles w/Caps & Screws Manijas de Anillo Grande con Casquetes y Tornillos
 <p><b>RP26865</b> Set Screws Tornillos de Ajuste</p> <p><b>RP20185</b> Retention Screws Tornillos de Retención</p>	 <p><b>RP26865</b> Set Screws Tornillos de Ajuste</p> <p><b>RP20185</b> Retention Screws Tornillos de Retención</p>	 <p><b>RP18343, RP18343AB, RP18343AL, RP18343PB, RP18343WH</b> Handle Cap Casquete del Manija</p> <p><b>RP5885</b> Screws/Tornillos</p> <p><b>RP18341, RP18341AB, RP18341AL, RP18341PB, RP18341WH</b> Handle Base Base de la Manija</p>
 <p><b>A62, A62AB, A62AL, A62CL, A62OK, A62PB, A62PR, A62RS, A62WH, A62WW</b> Handle Accents Acentos para Manijas</p>	 <p><b>A64, A64AL, A64CL, A64PB, A64WH</b> Handle Accents Acentos para Manijas</p>	 <p><b>A63, A63AB, A63AL, A63OK, A63PB, A63ST, A63WH</b> Handle Accents Acentos para Manijas</p>

See Page 19 for Handle Suffix Chart/Vea la tabla en página 19 para más detalles sobre sufijos de manijas



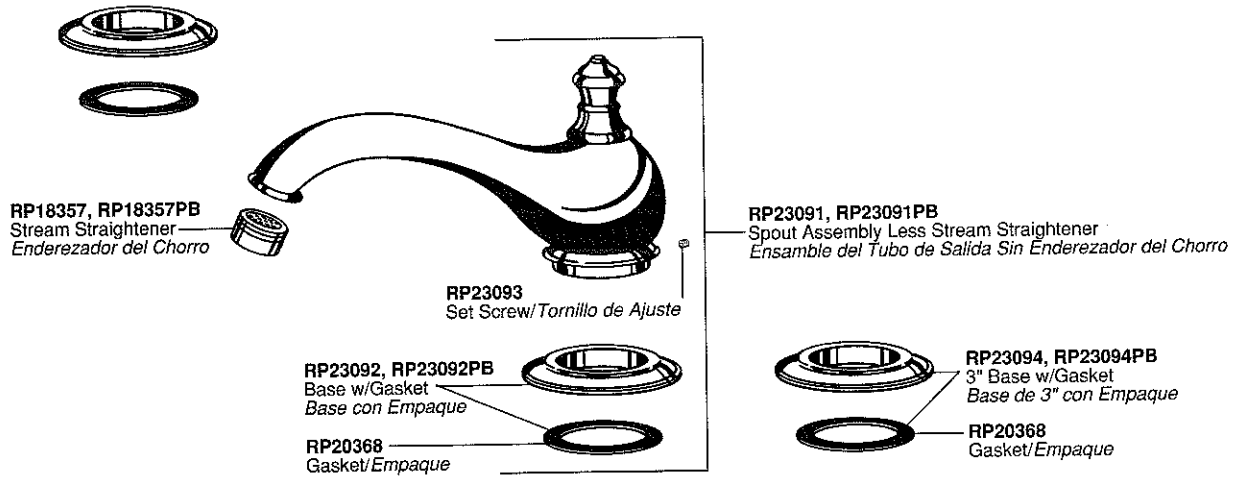

# Deck/Ledge Roman Tub Faucets Llaves para Bordes de Bañeras Romanas

Models/Modelos 2770 & 2771 Series

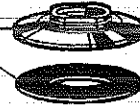

2770 Series Includes Conventional Rough-In Kit RP18227. See Page 74.  
La Serie 2770 incluye equipo para preparación de instalación convencional RP18227.  
Vea página 74.

2771 Series Includes Trim Only. Refer to Pages 74 & 75 for Rough-In Kit Options.  
La Serie 2771 sólo incluye la guarnición. Vea páginas 74 y 75 con opciones a para la preparación de instalación.

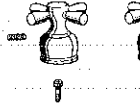
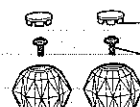
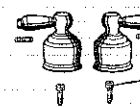
<p><b>OPTIONAL/OPCIONAL</b></p> <p>RP18300 2 1/2" Base w/Gasket Base de 2 1/2" con Empaque</p> <p>For Use w/Conventional Rough-In Kits Only Uso Sólo con Equipo para Preparación de Instalación Convencional</p> 	<p><b>H67, H67PB</b> Large Porcelain Cross Handles w/Screws Manijas de Cruz Pequeño de Porcelana con Tornillos</p>  <p>RP26865 Set Screws Tornillos de Ajuste</p> <p>RP20185 Retention Screws Tornillos de Retención</p>	<p><b>H66, H66AC, H66AP, H66CB, H66PB, H66WC, H66WP</b> Large Metal Cross Handles w/Set Screws Manijas de Cruz de Metal Mediana con Tornillos de Presión</p>  <p>RP26865 Set Screws Tornillos de Ajuste</p> <p>RP20185 Retention Screws Tornillos de Retención</p>
	<p><b>H61, H61PB</b> Large Knob Handles w/Buttons &amp; Screws Manijas de Perilla Grande con Botones y Tornillos</p>  <p>RP18373, RP18373PB Button Set (Red/Blue Indicators) Botones (Indicadores: Rojo/Azul)</p> <p>RP5885 Screws/Tornillos</p>	<p><b>H65, H65AC, H65AP, H65CA, H65CB, H65CK, H65CW, H65PA, H65PB, H65PK, H65PW, H65WC, H65WP</b> Large Lever Handles w/Screws Manijas de Grande de Palanca</p>  <p>RP26865 Set Screws/Tornillos de Ajuste</p> <p>RP20185 Retention Screws Tornillos de Retención</p>

See Page 19 for Handle Suffix Chart/Vea la tabla en página 19 para más detalles sobre sufijos de manijas

▲ Designate proper finish suffix. Verify available finishes in Miscellaneous Parts Section. **Note:** Chrome models have no finish suffix. AL=Almond, CB=Chrome/Polished Brass, CP=Polished Brass/Chrome, PB=Polished Brass, WH=White.

▲ Designe el sufijo apropiado para el acabado. Verifique acabados disponibles en la sección de Piezas Misceláneas. **Nota:** El acabado de los modelos de cromo no tienen sufijo. AL=Almendra, CB=Cromo/Bronce Pulido, CP=Bronce Pulido/Cromo, PB=Bronce Pulido, WH=Blanco.

## Models/Modelos 2780 & 2781 Series

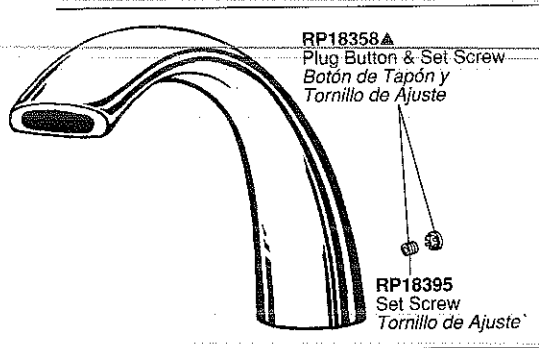
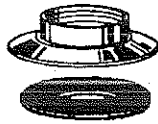



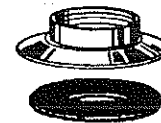

RP18908▲  
Spout Assembly  
Ensamble del Tubo de Salida

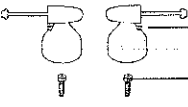
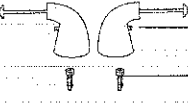
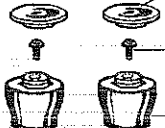

RP18543▲  
3" Base w/Gasket  
Base de 3" con Empaque

2780 Series Includes Conventional Rough-In Kit RP18227. See Page 74.  
La Serie 2780 incluye equipo para preparación de instalación convencional RP18227. Vea página 74.

2781 Series Includes Trim Only. Refer to Pages 74 & 75 for Rough-In Kit Options.  
La Serie 2781 sólo incluye la guarnición. Vea páginas 74 y 75 con opciones a para la preparación de instalación.

<p><b>H62, H62AB, H62AL, H62PB, H62WH</b> Large Lever Handles w/Screws Manijas Grande de Palanca con Tornillos</p>  <p>RP26865 Set Screws Tornillos de Ajuste RP20185 Retention Screws Tornillos de Retención</p>	<p><b>H64, H64AL, H64PB, H64WH</b> Large Lever Handles w/Screws Manijas Grande de Palanca con Tornillos</p>  <p>RP26865 Set Screws Tornillos de Ajuste RP20185 Retention Screws Tornillos de Retención</p>	<p><b>H63, H63AB, H63AL, H63PB, H63WH</b> Large Ring Handles w/Caps &amp; Screws Manijas de Anillo Grande con Casquetes y Tornillos</p>  <p>RP18343, RP18343AB, RP18343AL, RP18343PB, RP18343WH Handle Cap Casquete del Mango RP5885 Screws/Tornillos RP18341, RP18341AB, RP18341AL, RP18341PB, RP18341WH Handle Base Base de la Manija</p>
<p><b>A62, A62AB, A62AL, A62CL, A62OK, A62PB, A62PR, A62RS, A62WH, A62WW</b> Handle Accents Acentos para Manijas</p> 	<p><b>A64, A64AL, A64CL, A64PB, A64WH</b> Handle Accents Acentos para Manijas</p> 	<p><b>A63, A63AB, A63AL, A63OK, A63PB, A63ST, A63WH</b> Handle Accents Acentos para Manijas</p> 

See Page 19 for Handle Suffix Chart/ Vea la tabla en página 19 para más detalles sobre sufijos de manijas

# Deck/Ledge Mount Rough-In Kit

## Montura de Bordos para Equipo para Preparación de Instalación

### Model RP23601 10" Fixed Conventional Rough-In Kit

#### Modelo RP23601 Equipo de Preparación para Instalación Fija Convencional de 10"

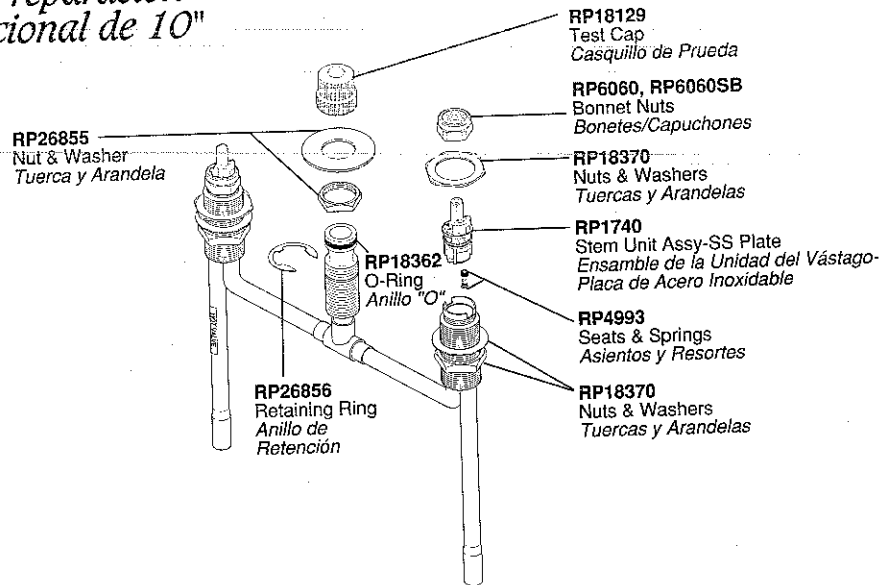

### Model RP18227 Conventional Rough-In Kit

#### Modelo RP18227 Equipo de Preparación para Instalación Convencional

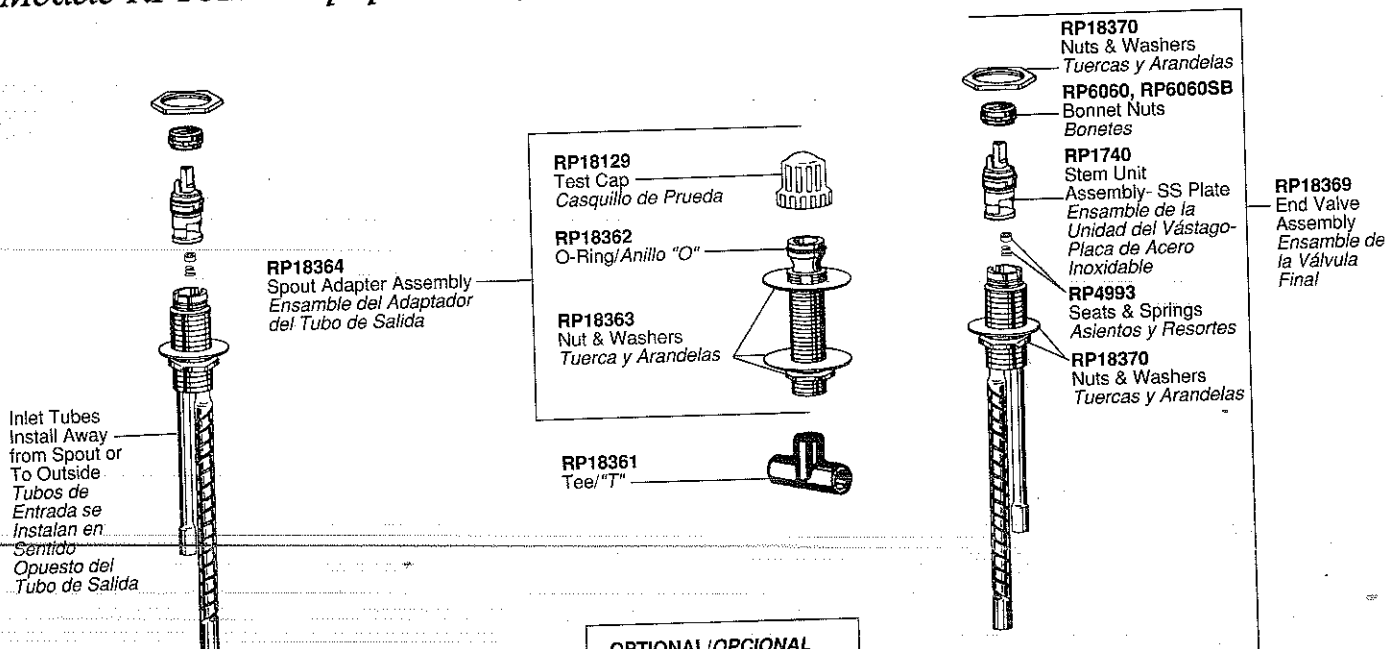

#### OPTIONAL/OPCIONAL

RP18300▲  
2 1/2" Base w/Gasket  
Base de 2 1/2" con  
Empaque



For Use w/Conventional  
Rough-In Kits Only  
Uso Sólo con Equipo para  
Preparación de Instalación

RP16867  
Wrench for End Valve  
Assembly  
Llave para Ensamble  
de Válvula Final



RP18504  
Thick Mounting Nuts &  
Washers for RP18227  
Only  
Tuercas y Arandelas para  
Montura en Paredes  
Gruesa Sólo RP18227



▲ Designate proper finish suffix. Verify available finishes in Miscellaneous Parts Section. **Note:** Chrome models have no finish suffix. AB=Antique Brass, PB=Polished Brass, WH=White.

▲ *Designe el sufijo apropiado para el acabado. Verifique acabados disponibles en la sección de Piezas Misceláneas. Nota: El acabado de los modelos de cromo no tienen sufijo. AB=Bronce Antiguo, PB=Bronce Pulido, WH=Blanco.*

## Model RP18235 Thick Tile Rough-In Kit Modelo RP18235 Equipo de Preparación para Instalación en Losas Gruesas

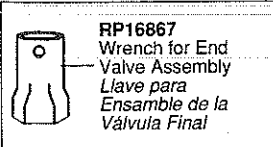
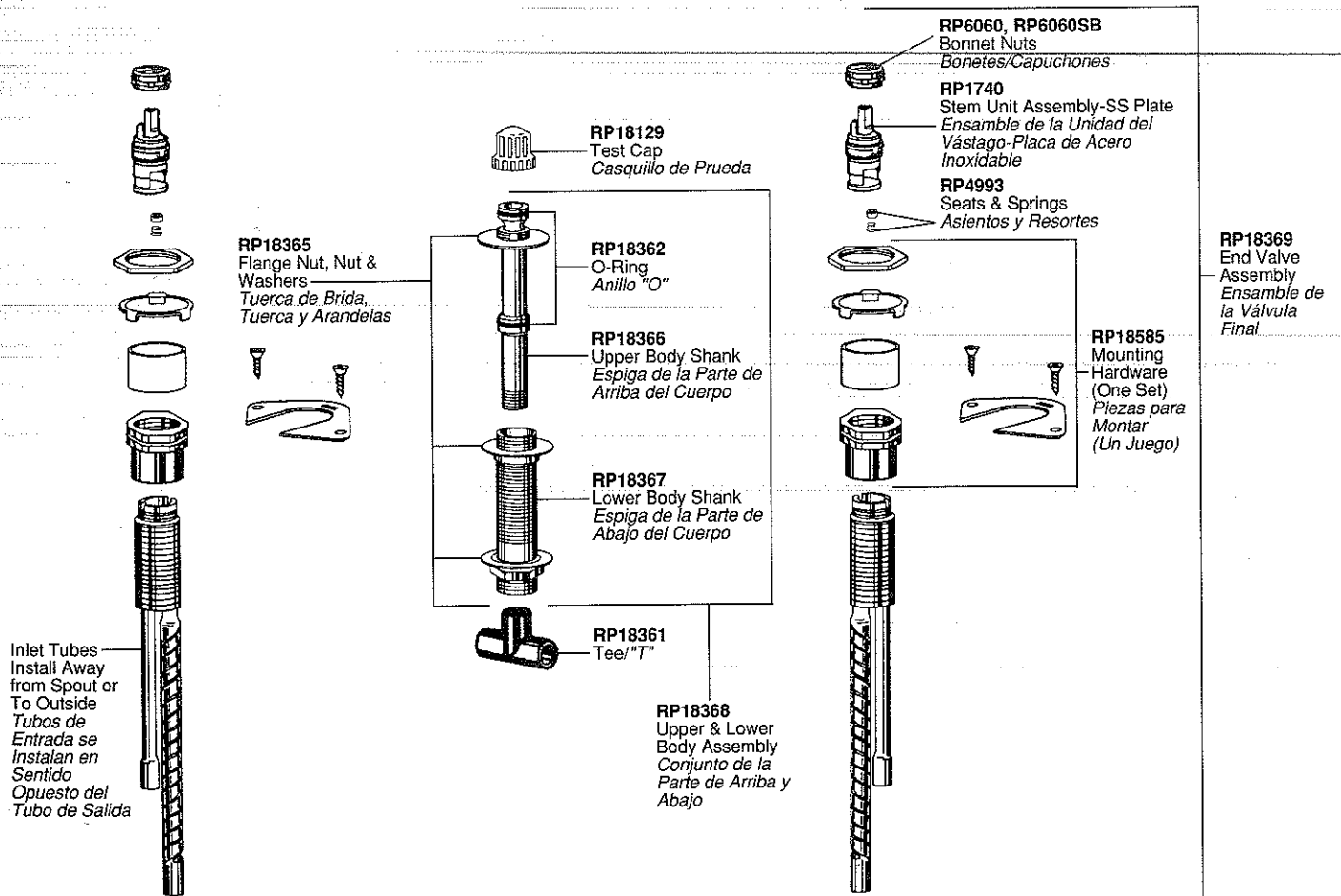

# Wall Mount Roman Tub Faucets Montura de Pared para Llaves de Bañeras Romanas

## Models/Modelos 2714 Series

▲ Designate proper finish suffix. Verify available finishes in Miscellaneous Parts Section. **Note:** Chrome models have no finish suffix. AB=Antique Brass, PB=Polished Brass. ▲ Designe el sufijo apropiado para el acabado. Verifique acabados disponibles en la sección de Piezas Misceláneas. **Nota:** El acabado de los modelos de cromo no tienen sufijo. AB=Bronce Antiguo, PB=Bronce Pulido.

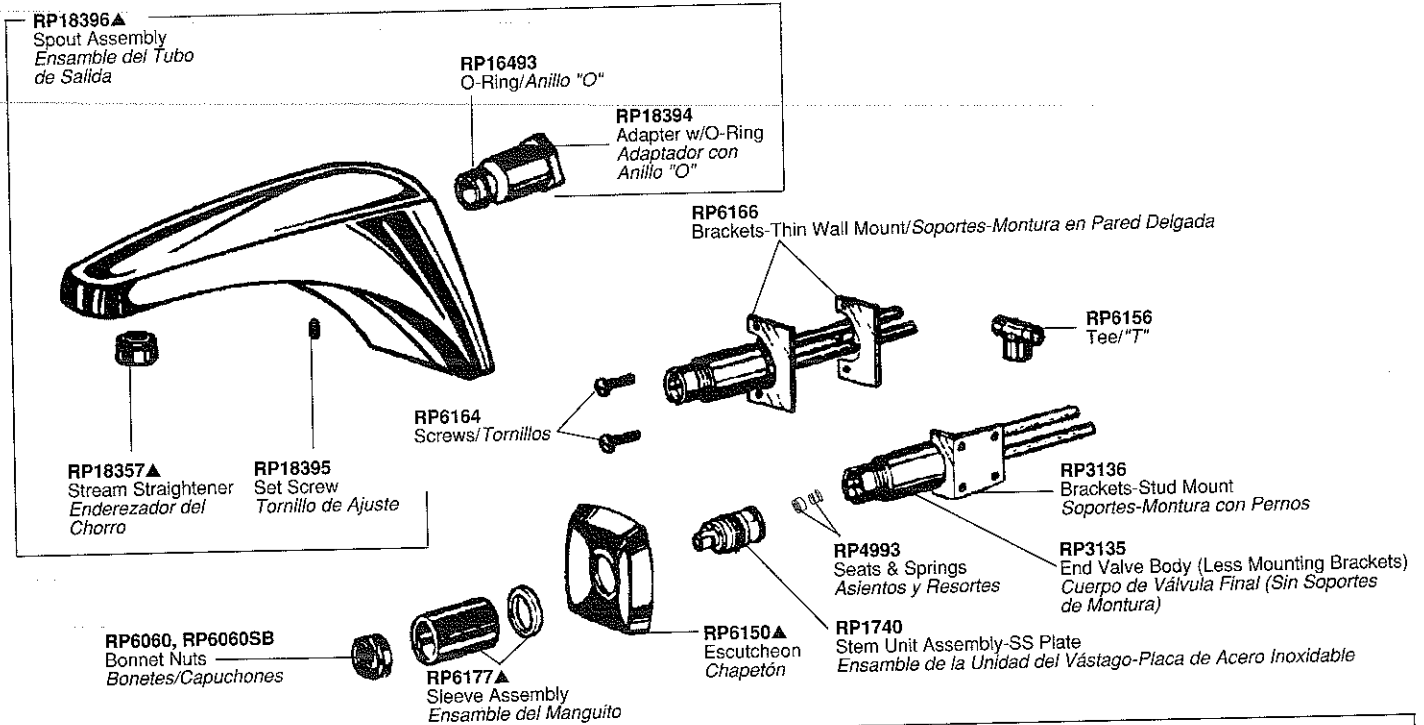

<p><b>H67, H67PB</b> Large Porcelain Cross Handles w/Screws Manijas de Cruz Grande de Porcelana con Tornillos</p> <p><b>RP26865</b> Set Screws Tornillos de Ajuste</p> <p><b>RP20185</b> Retention Screws Tornillos de Retención</p>	<p><b>H66, H66CB, H66PB</b> Large Metal Cross Handles w/Screws Manijas de Cruz de Metal Grande con Tornillos</p> <p><b>RP26865</b> Set Screws Tornillos de Ajuste</p> <p><b>RP20185</b> Retention Screws Tornillos de Retención</p>
<p><b>H48</b> Metal Knob Handles w/Buttons &amp; Screws Manijas de Perilla Metal con Botones y Tornillos</p> <p><b>RP19659</b> Button Set (Red/Blue Indicators) Botones (Indicadores: Rojo/Azul)</p> <p><b>RP5885</b> Screws/Tornillos</p>	<p><b>H41, H41PB</b> Medium Knob Handles w/Buttons &amp; Screws Manijas de Perilla Mediana con Botones y Tornillos</p> <p><b>RP18373, RP18373PB</b> Button Set (Red/Blue Indicators) Botones (Indicadores: Rojo/Azul)</p> <p><b>RP5885</b> Screws/Tornillos</p>
<p><b>H62, H62AB, H62PB</b> Large Lever Handles w/Screws Manijas de Grande de Palanca con Tornillos</p> <p><b>RP26865</b> Set Screws Tornillos de Ajuste</p> <p><b>RP20185</b> Retention Screws Tornillos de Retención</p> <p><b>A62, A62AB, A62AL, A62CL, A62OK, A62PB, A62PR, A62RS, A62WH, A62WW</b> Handle Accents Acentos para Manijas</p>	<p><b>H64, H64PB</b> Large Lever Handles w/Screws Manijas Grande de Palanca con Tornillos</p> <p><b>RP26865</b> Set Screws Tornillos de Ajuste</p> <p><b>RP20185</b> Retention Screws Tornillos de Retención</p> <p><b>A64, A64AL, A64CL, A64PB, A64WH</b> Handle Accents Acentos para Manijas</p>
<p><b>H65, H65CA, H65CB, H65CK, H65CW, H65PA, H65PB, H65PK, H65PW</b> Large Lever Handles w/Screws Manijas de Grande de Palanca con Tornillos</p> <p><b>RP26865</b> Set Screws/Tornillos de Ajuste</p> <p><b>RP20185</b> Retention Screws Tornillos de Retención</p> <p><b>H63, H63AB, H63PB</b> Large Ring Handles w/Caps &amp; Screws Manijas de Anillo Grande con Casquetes y Tornillos</p> <p><b>RP18343, RP18343AB, RP18343PB</b> Handle Cap/Casquete del Manija</p> <p><b>RP5885</b> Screws/Tornillos</p> <p><b>RP18341, RP18341AB, RP18341PB</b> Handle Base/Base de la Manija</p> <p><b>A63, A63AB, A63AL, A63OK, A63PB, A63ST, A63WH</b> Handle Accents Acentos para Manijas</p>	

See Page 19 for Handle Suffix Chart/Vea la tabla en página 19 para más detalles sobre sufijos de manijas

# Roman Tub Hand Held Showers

## Regaderas de Mano para Llaves de Bañeras Romanas

### Models/Modelos RP14979 Series

▲ Designate proper finish suffix. Verify available finishes in Miscellaneous Parts Section. **Note:** Chrome models have no finish suffix. AB=Antique Brass, AL=Almond, PB=Polished Brass, WH=White.

▲ Designe el sufijo apropiado para el acabado. Verifique acabados disponibles en la sección de Piezas Misceláneas. **Nota:** El acabado de los modelos de cromo no tienen sufijo. AB=Bronce Antiguo, AL=Aimendra, PB=Bronce Pulido, WH=Blanco.

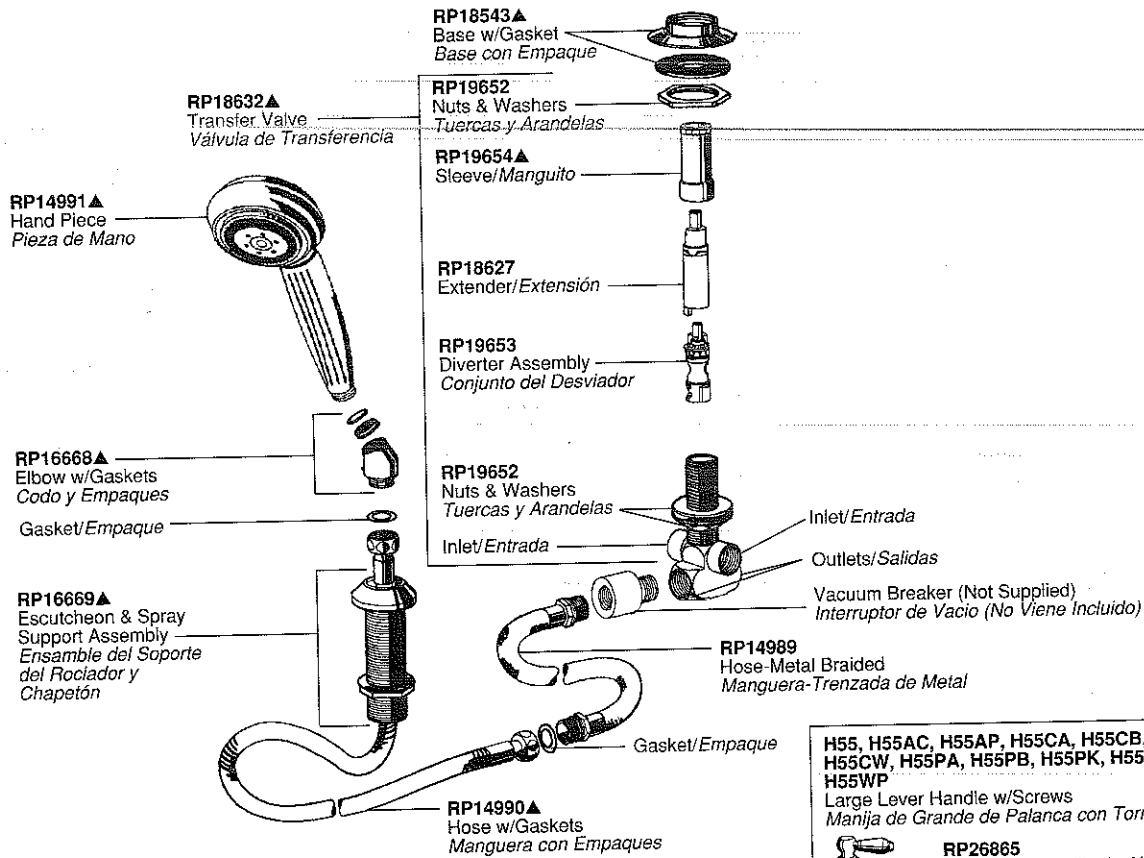

**H55, H55AC, H55AP, H55CA, H55CB, H55CK, H55CW, H55PA, H55PB, H55PK, H55PW, H55WC, H55WP**  
Large Lever Handle w/Screws  
Manija de Grande de Palanca con Tornillos

**RP26865**  
Set Screw/Tornillo de Ajuste

**RP20184**  
Retention Screw/Tornillo de Retención

**H51, H51PB**  
Large Knob Handle w/Button & Screw  
Manija de Perilla Grande con Botón y Tornillo

**RP18429, RP18429PB**  
Button-Arrow/Botón-Flecha

**RP18678**  
Screw/Tornillo

**H57, H57PB**  
Large Porcelain Cross Handle w/Screws  
Manija de Cruz Grande de Porcelana con Tornillos

**RP26865**  
Set Screw  
Tornillo de Ajuste

**RP20184**  
Retention Screw  
Tornillo de Retención

**H56, H56AC, H56AP, H56CB, H56PB, H56WC, H56WP**  
Large Metal Cross Handle w/Screws  
Manija de Cruz de Metal Grande con Tornillos

**RP26865**  
Set Screw  
Tornillo de Ajuste

**RP20184**  
Retention Screw  
Tornillo de Retención

**H52, H52AB, H52AL, H52PB, H52WH**  
Large Lever Handle w/Screws  
Manija de Grande de Palanca con Tornillos

**RP26865**  
Set Screw  
Tornillo de Ajuste

**RP20184**  
Retention Screw  
Tornillo de Retención

**H54, H54AL, H54PB, H54WH**  
Large Lever Handle w/Screws  
Manija Grande de Palanca con Tornillos

**RP26865**  
Set Screw  
Tornillo de Ajuste

**RP20184**  
Retention Screw  
Tornillo de Retención

**H53, H53AB, H53AL, H53PB, H53WH**  
Large Ring Handle w/Cap & Screw  
Manija de Anillo Grande con Casquete y Tornillo

**RP18343, RP18343AB, RP18343AL, RP18343PB, RP18343WH**  
Handle Cap/Casquete del Manija

**RP18678**  
Screw/Tornillo

**RP18341, RP18341AB, RP18341AL, RP18341PB, RP18341WH**  
Handle Base/Base de la Manija

**A52CL, A72, A72AB, A72AL, A72OK, A72PB, A72PR, A72RS, A72WH, A72WW**  
Handle Accent  
Acento para Manija

**A54CL, A74, A74AL, A74PB, A74WH**  
Handle Accent  
Acento para Manija

**A73, A73AB, A73AL, A73OK, A73PB, A73ST, A73WH**  
Handle Accent  
Acento para Manija

See Page 19 for Handle Suffix Chart/Vea la tabla en página 19 para más detalles sobre sufijos de manijas

# Bidet Valves Válvulas para Bidés

## Model/Modelo 33 Series

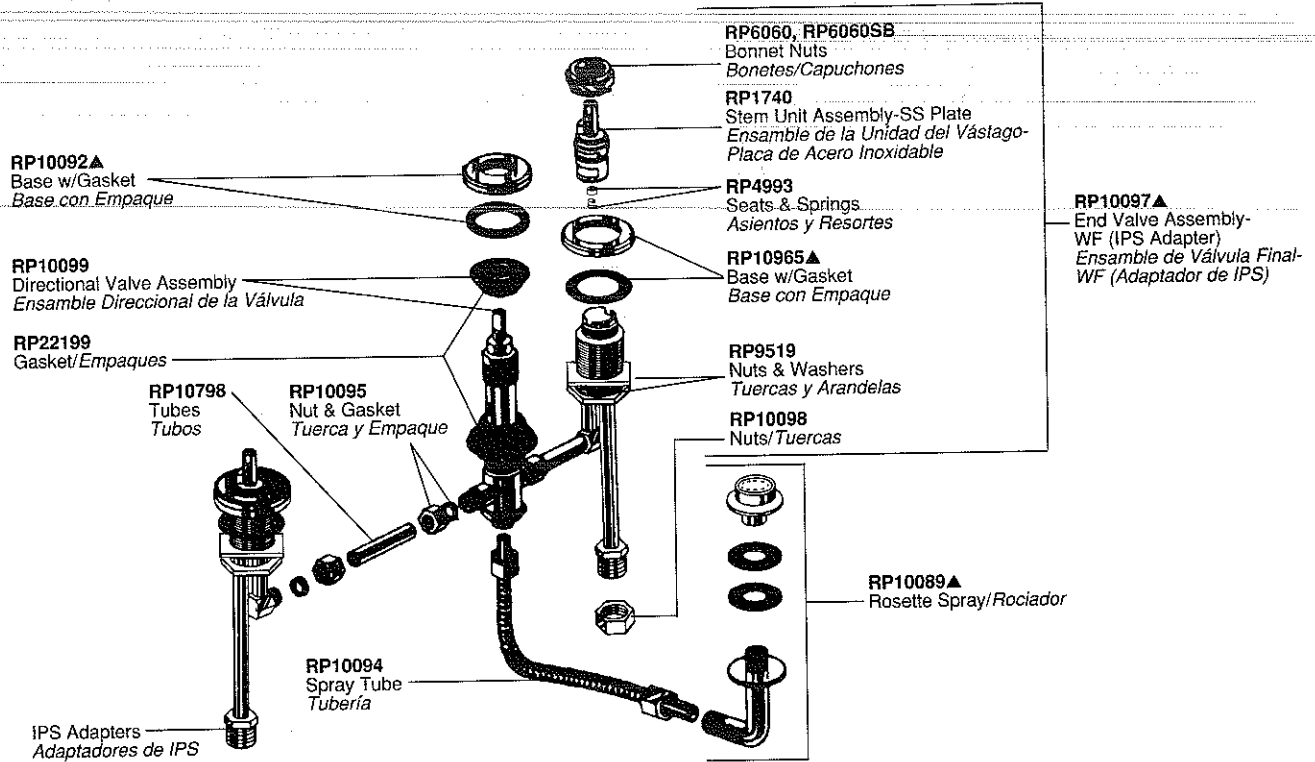

## Model/Modelo 44 Series

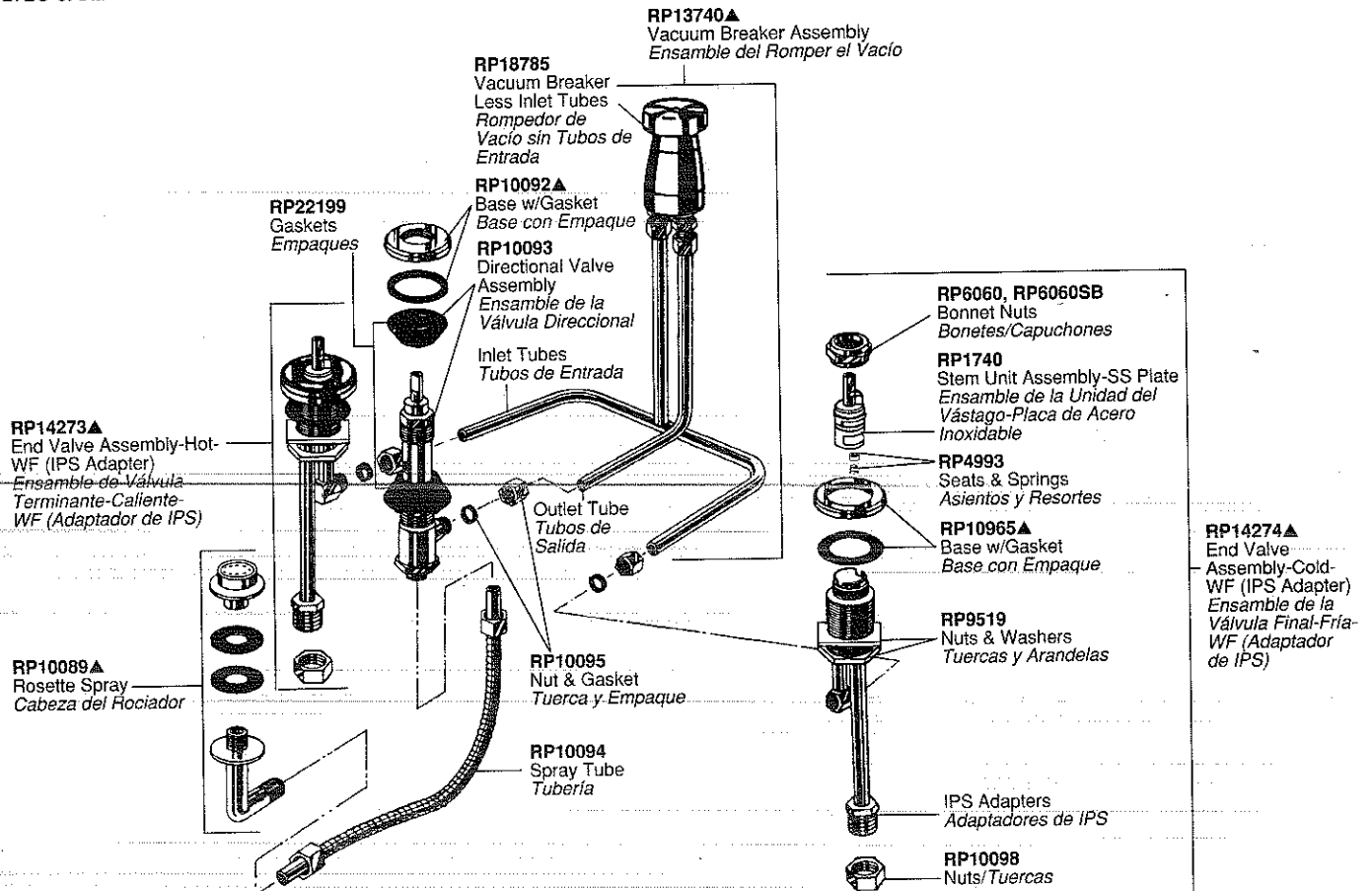

▲ Designate proper finish suffix. Verify available finishes in Miscellaneous Parts Section. **Note:** Chrome models have no finish suffix. AB=Antique Brass, AL=Almond, CB=Chrome/Polished Brass, PB=Polished Brass, WH=White.

▲ Designe el sufijo apropiado para el acabado. Verifique acabados disponibles en la sección de Piezas Misceláneas. **Nota:** El acabado de los modelos de cromo no tienen sufijo. AB=Bronce Antiguo, AL=Almendra, CB=Cromo/Bronce Pulido, PB=Bronce Pulido, WH=Blanco.

**RP5651▲**  
Pop-Up Assembly  
Ensamble del Desagüe Automático

**RP24▲**  
Rod Guide Assembly  
Ensamble de la Barra de Guía

**RP5859▲**  
Flange/Brida  
**RP5869**  
Nut & Washer  
Tuerca y Arandela  
**RP5865▲**  
Sleeve  
Manguito

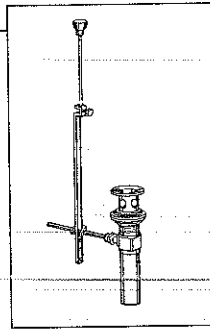

**RP22132**  
Helpful Hand Installation Aid  
Utensilio para Asistencia en Instalaciones a Mano

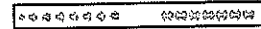

**RP10612**  
**RP11096** (Bulk Kit/Equipo de Cantidades Grandes)  
Thick Tile Mounting Kit for Bidet End Valves  
Equipo para Monturas en Losa Gruesa para Válvulas para Bidés Final

■ Refer to pages 44-45 for lavatory drain assemblies. *Vea páginas 44-45 para ensambles de los desagües de lavamanos.*

## Divertor Handles/Manijas de Desviador

**H11, H11PB**  
Small Knob Handle w/Button & Screw  
Manija de Perilla Pequeña con Botón y Tornillo

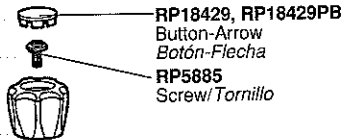

Use H11 w/Lever End Valve Handles  
Use H11 con Válvulas para Palancas

**H13, H13AB, H13AL, H13PB, H13WH**  
Small Ring Handle w/Cap & Screw  
Manija de Anillo Pequeña con Casquete y Tornillo

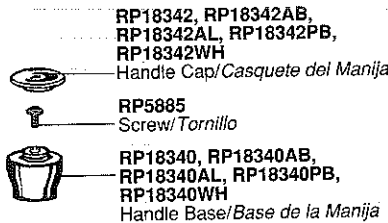

**A13, A13AB, A13AL, A13OK, A13PB, A13ST, A13WH**  
Handle Accent  
Acento para Manija

**H36, H36AC, H36AP, H36CB, H36PB, H36WC, H36WP**  
Medium Metal Cross Handle w/Screws  
Manija de Cruz de Metal Mediana con Tornillos

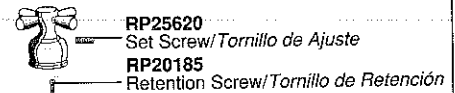

**H17, H17PB**  
Small Porcelain Cross Handle w/Screws  
Manija de Cruz Pequeña de Porcelana con Tornillos

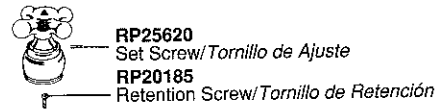

## End Valve Handles/Válvulas para Manijas Final

**H21, H21PB**  
Small Knob Handles w/Buttons & Screws  
Manijas de Perilla Pequeña con Botones y Tornillos

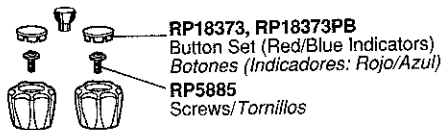

**H22, H22AB, H22AL, H22PB, H22WH**  
Small Lever Handles w/Screws  
Manijas Pequeña de Palanca con Tornillos

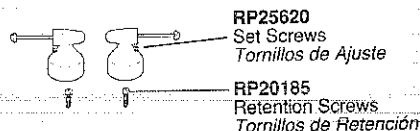

Use H11 as Divertor Handle/H11 con Válvulas/Palancas

**A22, A22AB, A22AL, A22CL, A22OK, A22PB, A22PR, A22RS, A22WH, A22WW**  
Handle Accents w/Finial  
Accesorios de Manijas on Botón para la Barra del Desagüe

**H25, H25AC, H25AP, H25CA, H25CB, H25CW, H25CK, H25PA, H25PB, H25PK, H25PW, H25WC, H25WP**  
Small Lever Handles w/Screws  
Manijas de Pequeña de Palanca con Tornillos

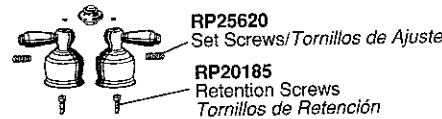

Use H11 as Divertor Handle/H11 con Válvulas/Palancas

**H23, H23AB, H23AL, H23PB, H23WH**  
Small Ring Handles w/Caps & Screws  
Manijas de Anillo Pequeña con Casquetes y Tornillos

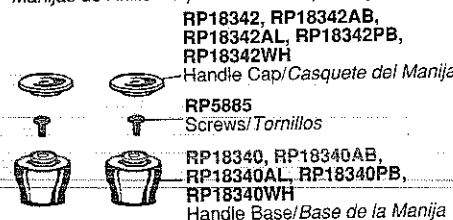

**A23, A23AB, A23AL, A23OK, A23PB, A23ST, A23STAB, A23STAL, A23STPB, A23STWH, A23WH**  
Handle Accents w/Finial  
Acces. de Manijas/Botón/Barra

**H26, H26AC, H26AP, H26CB, H26PB, H26WC, H26WP**  
Small Metal Cross Handles w/Screws  
Manijas de Cruz de Metal Pequeño con Tornillos

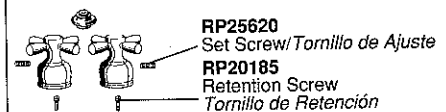

**H27, H27PB**  
Small Porcelain Cross Handles w/Screws  
Manijas de Cruz Pequeña de Porcelana con Tornillos

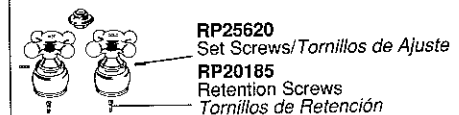

**H24, H24AL, H24PB, H24WH**  
Small Lever Handles w/Screws  
Manijas Pequeña de Palanca con Tornillos

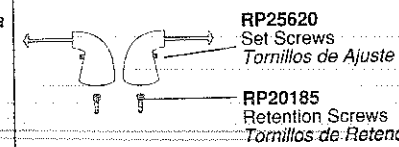

Use H11 as Divertor Handle/H11 con Válvulas/Palancas

**A24, A24AL, A24CL, A24PB, A24WH**  
Handle Accents w/Finial  
Accesorios de Manijas on Botón para la Barra del Desagüe



# Bath Wastes

## Desaghe de la Bañera

### Models/Modelos

RP291 (20 ga. Brass/Bronce) Series

RP691 (17 ga. Brass/Bronce) Series  
Trip Lever/Palanquita de Desenganche

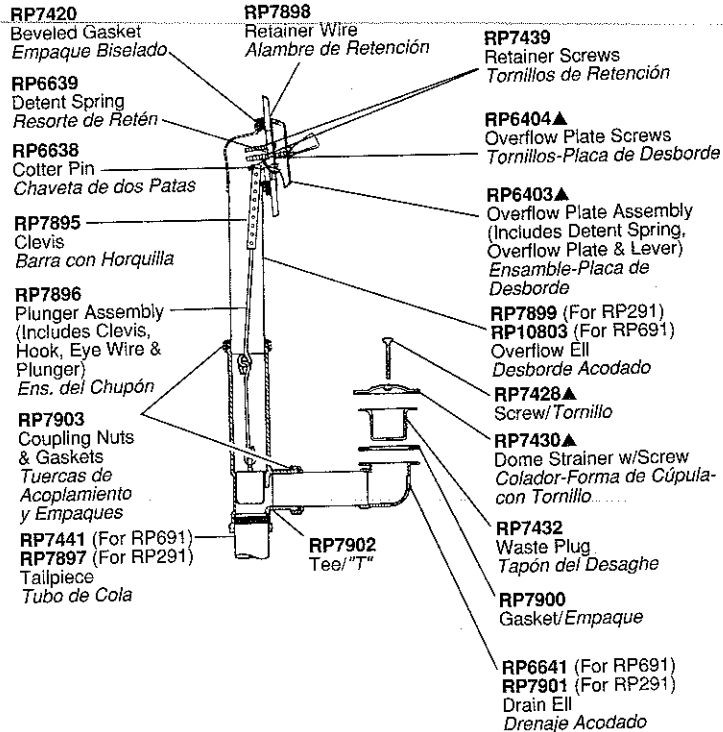

### Model/Modelo

RP391 (Polypropylene/Polipropileno) Series  
Trip Lever/Palanquita de Desenganche

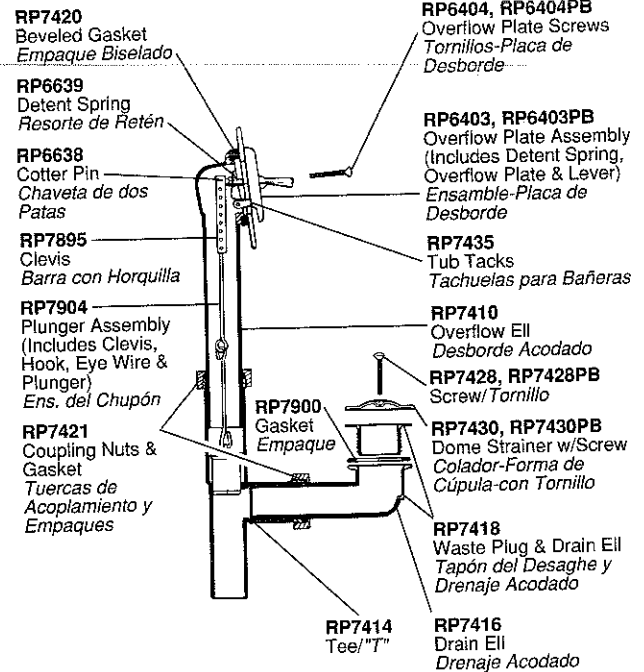

### Model/Modelo

RP695 (17 ga. Brass/Bronce) Series  
Lift & Turn/Alce y Gire

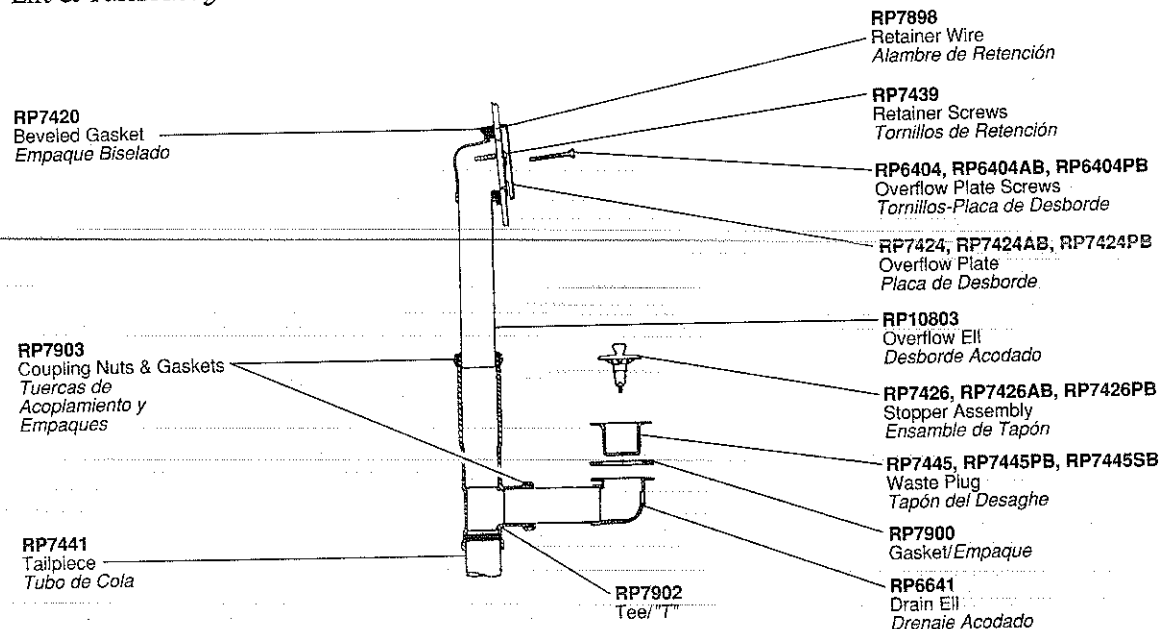

▲ Designate proper finish suffix. Verify available finishes in Miscellaneous Parts Section. **Note:** Chrome models have no finish suffix. AB=Antique Brass, AL=Almond, PB=Polished Brass, SB=Satin Brass, WH=White.

▲ *Designe el sufijo apropiado para el acabado. Verifique acabados disponibles en la sección de Piezas Misceláneas. **Nota:** El acabado de los modelos de cromo no tienen sufijo. AB=Bronce Antiguo, AL=Almendra, PB=Bronce Pulido, SB=Bronce Satinado, WH=Blanco.*

## Models/Modelos

RP293 (20 ga. Brass/Bronce) Series

RP693 (17 ga. Brass/Bronce) Series

Toe Operated/Operado con el Pie

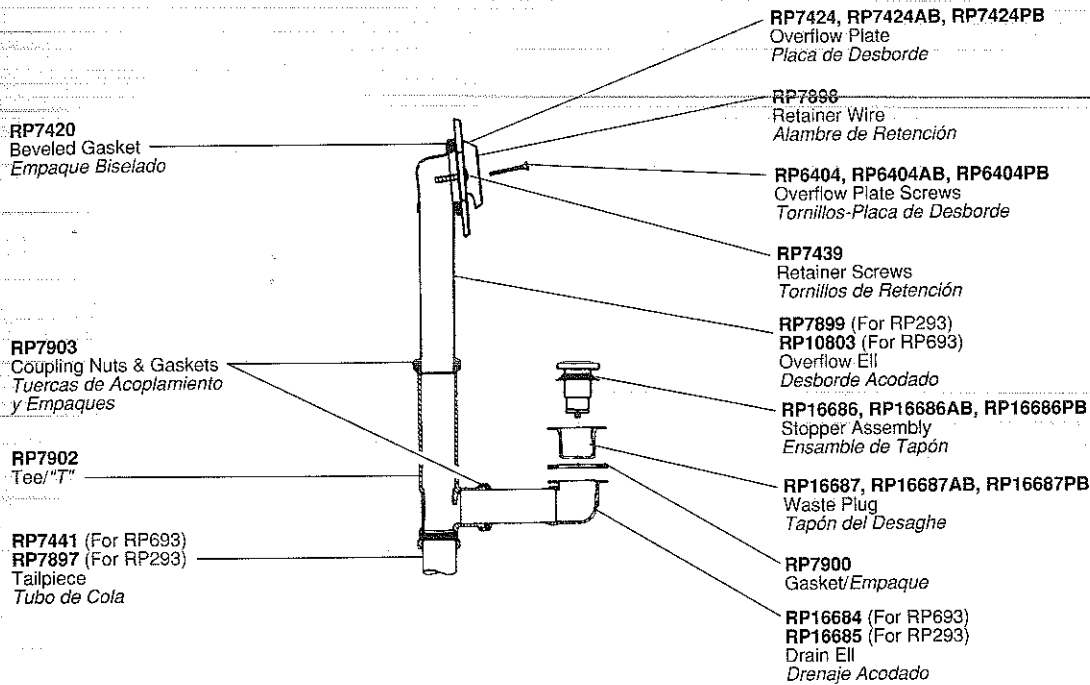

## Model/Modelo

RP393 (Polypropylene/Polipropileno) Series

Toe Operated/Operado con el Pie

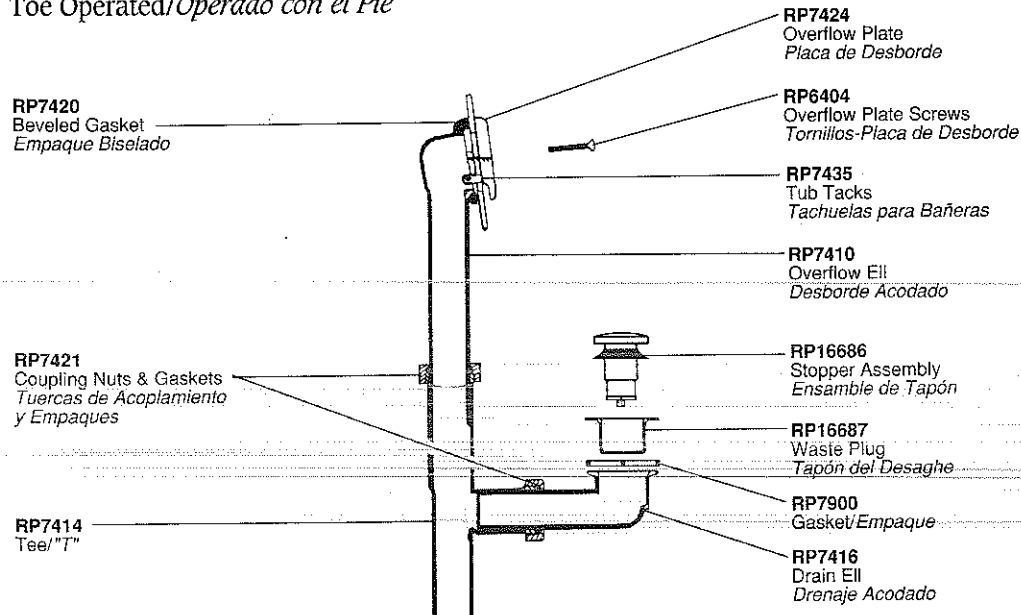

# Miscellaneous Parts/Piezas Misceláneas

**A12, A12AB, A12AL, A12CL, A12OK, A12PB, A12PR, A12RS, A12WH, A12WW**  
Lever-Small-3H T/S  
Palanca-Pequeña-3H T/S



**A13, A13AB, A13AL, A13OK, A13PB, A13ST, A13WH**  
Ring-Small-Basin/3H T-S/Bidet  
Anillo-Pequeño-Lavamanos/3H T-S/Bidé



**A14, A14AL, A14CL, A14PB, A14WH**  
Lever-Small-3H T/S  
Palanca-Pequeña-3H T/S



**A22, A22AB, A22AL, A22CL, A22OK, A22PB, A22PR, A22RS, A22WH, A22WW**  
Levers w/Finial-Small-Kit/Bar/Lav/2-3H T-S/Bidet  
Palancas con Botón para Alzar el Desaghe-Pequeñas-Coc/Bar/Lav/2-3H T-S/Bidé

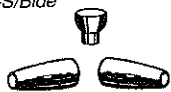

**A23, A23AB, A23AL, A23OK, A23PB, A23ST, A23STAB, A23STAL, A23STPB, A23STWH, A23WH**  
Rings w/Finial-Small-Kit/Bar/Lav/2-3H T-S/Bidet  
Anillos con Botón para Alzar el Desaghe-Pequeñas-Coc/Bar/Lav/2-3H T-S/Bidé



**A24, A24AL, A24CL, A24PB, A24WH**  
Levers w/Finial-Small-Kit/Bar/Lav/2-3H T-S/Bidet  
Palancas con Botón para Alzar el Desaghe-Pequeñas-Coc/Bar-Lab/2-3 T-S/Bidé



**A52CL**  
Lever-Large-RT Handshower  
Palanca-Grande-RT Regadera de Mano



**A54CL**  
Lever-Large-RT Handshower  
Palanca-Grande-RT Regadera de Mano



**A62, A62AB, A62AL, A62CL, A62OK, A62PB, A62PR, A62RS, A62WH, A62WW**  
Levers-Large-RT  
Palancas-Grandes-RT



**A63, A63AB, A63AL, A63OK, A63PB, A63ST, A63WH**  
Rings-Large-RT  
Anillos-Grandes-RT



**A64, A64AL, A64CL, A64PB, A64WH**  
Levers-Large-RT  
Palancas-Grandes-RT

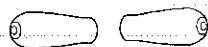

**A72, A72AB, A72AL**  
Lever-Large-1400/1500/RT Handshower  
Palanca-Grande-1400/1500/RT Regadera de Mano



**A72CL**  
Lever-Large-1400/1500  
Palanca-Grande-1400/1500



**A72OK, A72PB, A72PR, A72RS, A72WH, A72WW**  
Lever-Large-1400/1500/RT Handshower  
Palanca-Grande-1400/1500/RT Regadera de Mano



**A73, A73AB, A73AL, A73OK, A73PB, A73ST, A73WH**  
Ring-Large-1400/RT Handshower  
Anillo-Grandes-1400/RT Regadera de Mano



**A74, A74AL**  
Lever-Large-1400/1500/RT Handshower  
Palanca-Grande-1400/1500/RT Regadera de Mano

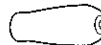

**A74CL**  
Lever-Large-1400/1500  
Palanca-Grande-1400/1500



**A74PB, A74WH**  
Lever-Large-1400/1500/RT Handshower  
Palanca-Grande-1400/1500/RT Regadera de Mano



**H11**  
**H11PB** (for antique & polished brass/para bronce antigua y pulido)  
Clear Knob Handle w/Hot/Cold/Arrow Buttons & Screw-Basin/3H T-S/Bidet  
Perilla Transparente con Botones con Flecha Agua Fria/Caliente y Tornillo-Lav/3H T-S/Bidé



**H12, H12AB, H12AL, H12PB, H12WH**  
Lever Handle Base w/Screws-Small-3H T/S  
Base para Manija de Palanca con Tornillos-Pequeña-3H T/S

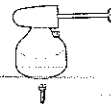

**H13, H13AB, H13AL, H13PB, H13WH**  
Ring Handle Base w/Cap & Screw-Small-Basin/3H T-S/Bidet  
Base para Manija de Anillo con Tapa y Tornillo-Pequeña-Lavamanos/3H T-S/Bidé



**H14, H14AL, H14PB, H14WH**  
Lever Handle Base w/Screws-Small-3H T/S  
Base para Manija de Palanca con Tornillos-Pequeña-3H T/S

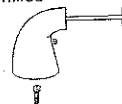

**H15, H15AC, H15AP, H15CA, H15CB, H15CK, H15CW, H15PA, H15PB, H15PK, H15PW, H15WC, H15WP**  
Lever Handle w/Screws-Small-3H T/S  
Palanca con Tornillos-Pequeña-3H T/S



**H17, H17PB**  
Porcelain Cross Handle w/Arrow Indicator & Screws-Small-Basin/3H T-S/Bidet  
Manija/Cruz-Porcelana/con Flecha Indicadora y Tornillos-Pequeña-Lav/3H T-S/Bidé

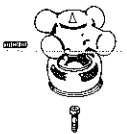

**H18**  
Metal Knob Handle w/Screw-Small-Basin (Plain)  
Perilla de Metal con Tornillo-Pequeña-Lavamanos (Sencillo)



**H21**  
**H21PB** (for antique & polished brass/para bronce antiguo o pulido)  
Clear Knob Handles w/Buttons, Screws & Finial-Small-Kit/Bar/Lav/Laundry/2-3H T-S/Bidet  
Perillas Transparentes con Botones, Tornillos y Botón para Alzar el Desaghe-Pequeñas-Coc/Bar/Lav/Lavandería/2-3H T-S/Bidé

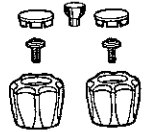

**H22, H22AB, H22AL, H22PB, H22WH**  
Lever Handle Bases w/Screws-Small-Kit/Bar/Lav/2-3H T-S/Bidet  
Bases para Palancas con Tornillos-Pequeñas-Coc/Bar-Lav/2-3H T-S/Bidé

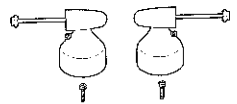

**H23, H23AB, H23AL, H23PB, H23WH**  
Ring Handle Bases w/Caps & Screws-Small-Kit/Bar/Lav/2-3H T-S/Bidet  
Bases para Manijas de Anillo con Tapas y Tornillos-Pequeñas-Coc/Bar/Lav/3H T-S/Bidé

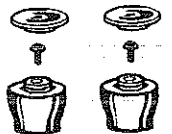

**H24, H24AL, H24PB, H24WH**  
Lever Handle Bases w/Screws-Small-Kit/Bar/Lav/2-3H T-S/Bidet  
Bases para Palancas con Tornillos-Pequeñas-Coc/Bar-Lav/2-3H T-S/Bidé

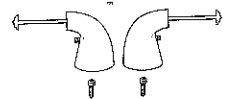

**H25, H25AC, H25AP, H25CA, H25CB, H25CK, H25CW, H25PA, H25PB, H25PK, H25PW, H25WC, H25WP**  
Lever Handles w/Screws & Finial-Small-Kit/Bar/Lav/2-3H T-S/Bidet  
Palancas con Tornillos y Botón para Alzar el Desaghe-Pequeña-Coc/Bar/Lav/2-3H T-S/Bidé

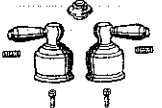

**H26, H26AC, H26AP, H26CB, H26PB, H26WC, H26WP**  
Metal Cross Handles w/Screws & Finial-Small-Bar/Lav/Bidet  
Manijas/Cruz-Metal-con Botón para Alzar el Desaghe-Pequeñas/Bar/Lav/Bidé

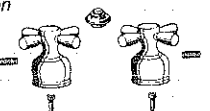

\* Check for inventory on discontinued parts. Vea el inventario para obtener piezas discontinuadas.

**H27, H27PB**  
Porcelain Cross Handles w/Screws & Finial-Small-Kit/Bar/Lav/2-3H T-S/Bidet  
Manijas/Cruz-Porcelana/con Tornillos y Botón para Alzar el Desaghe-Pequeño-Coc/Bar/Lav/2-3H T-S/Bidé



**H28**  
Blade Handles w/Buttons, Screws & Finial-Small-Kit/Bar/Centerset Lav/Laundry/2H T-S  
Manijas-Aletas, con Botones, Tornillos y Botón para Alzar el Desaghe-Pequeño-Coc/Bar/Lav de Montura de Centro/Lavanderia/2H T-S

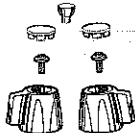

**H31**  
**H31PB** (for antique and polished brass/para bronce antiguo y bronce pulido)  
Clear Knob Handle w/Arrow Button & Screw-Medium-Basin/3H T-S/Bidet  
Perilla Transparente con Botón-Flecha y Tornillos-Mediana-Lav/3H T-S/Bidé



**H36, H36AC, H36AP, H36CB, H36PB, H36WC, H36WP**  
Metal Cross Handle w/Screws-Medium-Basin/3H T-S/Bidet  
Manija de Cruz/Metal/con Tornillos-Mediana-Lav/3H T-S/Bidé

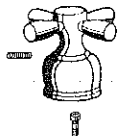

**H41**  
**H41PB** (for antique and polished brass/para bronce antiguo y bronce pulido)  
Clear Knob Handles w/Buttons, Screws & Finial-Medium-Kit/WS Lav/2-3H T-S/ 2714/2708  
Perillas Transparentes con Botones, Tornillos y Botón para Alzar el Desaghe-Mediana-Coc/WS Lav/2-3H T-S/2714/2708

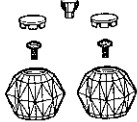

**H46, H46AC, H46AP, H46CB, H46PB, H46WC, H46WP**  
Metal Cross Handles w/Screws-Medium-Kit/Basin/2-3H T-S  
Manija de Cruz/Metal/con Tornillos-Mediana-Coc/Lav/2-3H T-S

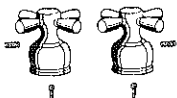

**H48**  
Metal Knob Handles w/Buttons, Screws & Finial-Medium-Kit/WS Lav/2H T-S/2714  
Perillas/Metal/con Botones, Tornillos y Botón para Alzar el Desaghe



**H51**  
**H51PB** (for antique and polished brass/para bronce antiguo y bronce pulido)  
Clear Knob Handle w/Arrow Button & Screw-Large-RT Handshower  
Perilla Transparente con Botón-Flecha y Tornillo-Grande-RT Regadera de Mano



**H52, H52AB, H52AL, H52PB, H52WH**  
Lever Handle Base w/Screws-Large-RT Handshower Base para Palanca con Tornillos-Grande-RT Regadera de Mano

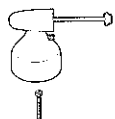

**H53, H53AB, H53AL, H53PB, H53WH**  
Ring Handle Base w/Cap & Screw-Large-RT Handshower  
Base de Manija de Anillo con Tapa y Tornillo-Grande-RT Regadera de Mano



**H54, H54AL, H54PB, H54WH**  
Lever Handle Base w/Screws-Large-RT Handshower  
Base de Manija-Palanca con Tornillos-Grande-RT Regadera de Mano

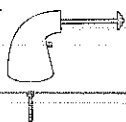

**H55, H55AC, H55AP, H55CA, H55CB, H55CK, H55CW, H55PA, H55PB, H55PK, H55PW, H55WC, H55WP**  
Lever Handle w/Screws-Large-RT Handshower  
Manija-Palanca y Tornillos-Grande-RT Regadera de Mano

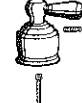

**H56, H56AC, H56AP, H56CB, H56PB, H56WC, H56WP**  
Metal Cross Handle w/Screws-Large-RT Handshower  
Manija/Cruz-Metal/con Tornillos-Grande-RT Regadera de Mano

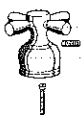

**H57, H57PB**  
Porcelain Cross Handle w/Arrow Indicator & Screws-Large-RT Handshower  
Manija/Cruz-Porcelana/con Flecha Indicadora y Tornillos-Grande-RT Regadera de Mano



**H61**  
**H61PB** (for antique and polished brass/para bronce antiguo y bronce pulido)  
Clear Knob Handles w/Buttons & Screws-Large-RT  
Perillas Transparentes con Botón-Flecha y Tornillo-Grande-RT Regadera de Mano

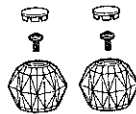

**H62, H62AB, H62AL, H62PB, H62WH**  
Lever Handle Bases w/Screws-Large-RT  
Bases para Manijas con Palancas con Tornillos-Grandes-RT

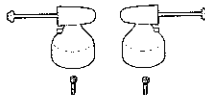

**H63, H63AB, H63AL, H63PB, H63WH**  
Ring Handle Bases w/Caps & Screws-Large-RT  
Bases para Manijas de Anillo con Tapas y Tornillos-Grandes RT

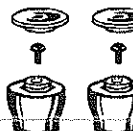

**H64, H64AL, H64PB, H64WH**  
Lever Handle Bases w/Screws-Large-RT  
Bases de Manijas con Palanca con Tornillos-Grandes-RT

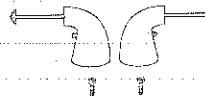

**H65, H65AC, H65AP, H65CA, H65CB, H65CK, H65CW, H65PA, H65PB, H65PK, H65PW, H65WC, H65WP**  
Lever Handles w/Screws-Large-RT  
Manijas con Palancas con Tornillos-Grandes-RT



**H66, H66AC, H66AP, H66CB, H66PB, H66WC, H66WP**  
Metal Cross Handles w/Screws-Large-RT  
Manijas de Cruz-Metal, con Tornillos-Grandes-RT

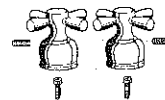

**H67, H67PB**  
Porcelain Cross Handles w/Screws-Large-RT  
Manijas de Cruz-Porcelana con Tornillos-Grandes-RT

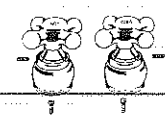

**H71**  
**H71PB** (for antique and polished brass/para bronce antiguo y pulido)  
Clear Knob Handle w/Arrow Button & Screw-Large-1300/1400/1600  
Perilla Transparente con Botón-Flecha y Tornillo-Grande-1300/1400/1600

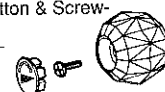

**H72, H72AB, H72AL, H72PB, H72WH**  
Lever Handle Base w/Screw-Large-1400  
Base para Manija-Palanca/Tornillo-Grande-1400

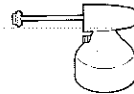

**H73, H73AB, H73AL, H73PB, H73WH**  
Ring Handle Base w/Arrow Indicator, Cap & Screw-Large-1400  
Base para Manija de Anillo/Flecha Indicadora, Tapa y Tornillo-Grande-1400

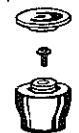

**H74, H74AL, H74PB, H74WH**  
Lever Handle w/Screw-Large-1400  
Manija-Palanca con Tornillo-Grande-1400

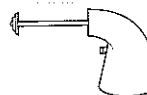

**H75, H75AC, H75AP, H75CA, H75CB, H75CK, H75CW, H75PA, H75PB, H75PK, H75PW, H75WC, H75WP**  
Lever Handle w/Screw-Large-1400  
Manija-Palanca con Tornillo-Grande-1400

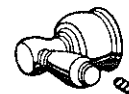

**H77, H77PB**  
Porcelain Cross Handle w/Arrow Indicator & Screw-Large-1400  
Manija de Cruz-Porcelana con Flecha Indicadora y Tornillo-Grande-1400



**H78**  
Blade Handle w/Screw-Large-1300/1400  
Manija-Aleta con Tornillo-Grande-1300/1400



**H79, H79AB, H79AL, H79PB, H79WH**  
Lever Handle w/Screw-Large-1300/1400  
Manija-Palanca con Tornillo-Grande-1300/1400



# Miscellaneous Parts/Piezas Misceláneas

**RP24, RP24AB, RP24PB, RP24SB\*, RP24WH**  
Lift Rod Guide Assy.-Bidet/570-P Series  
Ensamble Guía para Barra de Alzar-Bidé/  
570-P Series



**RP25**  
**RP25MBS** (120 per case/120 por caja)  
O-Rings-Spout-1H Kitchen  
Anillos "O"-Tubo de Salida-1H Cocina



**RPW33HDF**  
Showerhead-Adjustable Volume Control-Vandal  
Resistant-2.5 gpm @ 80 psi  
Cabeza de Regadera-Control de Volumen Ajustable-  
Resistente al Maltrato-9.5L/Min @ 551 kPa



**RP50, RP50AB, RP50AL, RP50PB, RP50SB\*, RP50WH**  
Cap w/Adj. Ring-Single Handle  
Tapa con Anillo Ajustable-Manija Sencilla



**RPW55HDF\*(VR/Resistente al Maltrato)**  
Showerhead-The Embracer®-Tapered Body-  
2.5 gpm @ 80 psi  
Cabeza de Regadera-The Embracer®-Ahusada-  
9.5L/Min @ 551 kPa

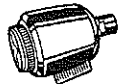

**RP61**  
**RP61MBS** (60 per case/60 por caja)  
Cam & Packing-Single Lever Handle  
Leva y Empaque-Manija de  
Palanca Sencilla



**RP65, RP65AB, RP65AC, RP65PB, RP65WC, RP65WP**  
Showerhead-The Embracer®-Cylindrical Body-  
2.5 gpm @ 80 psi  
Cabeza de Regadera-The Embracer®-Cilindrico-  
9.5L/Min @ 551 kPa

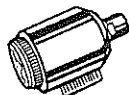

**RPW66HDF**  
Showerhead-The Embracer®-Cylindrical Body-VR-  
2.5 gpm @ 80 psi  
Cabeza de Regadera-The Embracer®-Cilindrico-  
Resistente al Maltrato-9.5L/Min @ 551 kPa

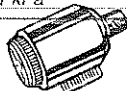

**RP70**  
**RP70MBS** (60 per case/60 por caja)  
Ball Assy.-Single Lever Handle-SS  
Ensamble de la Bola-Manija-Palanca  
Sencilla-Acero Inoxidable



**RPF75A**  
Toilet Tank Fill Valve  
Válvula para Llenar el  
Tanque-Inodoro

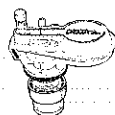

**RP76**  
Pipe Plug-1/2" IPS-T/S  
Tapón de Tubería-1/2" IPS-T/S



**RP90**  
Handle w/Set Screw  
Manija con Tornillo de Ajuste



**RPF95A**  
Toilet Tank Fill Valve - Anti-Siphon - Code Approved  
Válvula para Llenar el Tanque-Inodoro-  
Antisifonaje-Código Aprobado



**RPF96**  
Toilet Tank Flapper  
Tapón del Tanque del Inodoro



**RPF97**  
Fill Valve Replacement Disk for RPF75A  
Disco de Repuesto para Válvula de Llenar  
para RPF75A



**RPF98** - See/Ver RPF99

**RPF99**  
Fill Valve Replacement Disk, Vacuum Breaker Disk &  
Diaphragm for RPF95A  
Disco de Repuesto para Válvula  
de Llenar/Disco Rompedor de  
Vacío y Diafragma  
para RPF95A

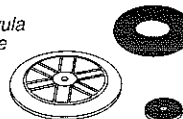

**RP116**  
Plasterguard/Thin Wall Mounting Bracket-600/1600  
Protector de Enlucido/Soporte para Montura en  
Pared Delgada-600/1600



**RP152, RP152AL, RP152WH**  
Set Screw-Single Lever Handle - 1/4-28x5/16"  
(uses 1/8" allen wrench)  
Tornillo de Ajuste-Manija-Palanca Sencilla-1/4"-28  
(Usa Llave Allen 1/8")



**RP188**  
**RP188MBS** (60 per case/60 por caja)  
Cam & Packing-Single Knob Handle  
Leva y Empaque-Perilla Sencilla



**RP196, RP196AB, RP196AL, RP196PB, RP196WH**  
Screws-1H T/S Escutcheon - 2 3/4"x10-24  
Tornillos-1H T/S Chapetón - 2 3/4"x10-24



**RP212**  
**RP212MBS** (60 per case/60 por caja)  
Ball Assembly-Single Knob Handle-SS  
Ensamble de la Bola-Manija-  
Palanca Sencilla-Acero Inoxidable



**RP238**  
Mounting Bolt-1H Kitchen  
Perno para Montura-1H Cocina



**RP246**  
Aerator w/Wrench-VR - 15/16"-27 Male Thread-  
2.0 gpm @ 80 psi  
Aireador con Llave de Tuerca-Resistente al  
Maltrato-15/16"-27 Rosca Macho-  
7.6L/Min @ 551 kPa



**RP250**  
**RP250MBS** (60 per case/60 por caja)  
Adjusting Ring-Single Handle  
Anillo de Ajuste-Manija Sencilla



**RP286**  
Spray Support-300  
Soporte del Rociador-200



**RP287**  
Shank for Spray-300  
Espiga para el Rociador-300

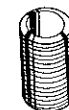

**RP288**  
Grommet-On Dispensers (Before 6/94) & Sprays  
Mounted on 1H Kit esc.  
Dispersadores con Aro de Refuerzo (Antes de 6/94)  
y Rociadores Montados en Chapetón de 1H Cocina



**RP291**  
Trip Lever Bath Waste Assy.-Brass  
Ensamble del Desagüe/Bañera/Operado  
con Palanquita de Desenganche-Bronce



**RP293**  
Toe-Operated Bath Waste Assy.-Brass  
Ensamble del Desagüe/Bañera/Operado  
con Pie-Bronce



**RP317**  
Mounting Nuts & Washers - 100-D/400-D Series  
(before 6/94) & 300 Series (after 6/94)  
Tuercas y Arandelas para  
Montura-Series 100-D/400-D  
(antes de 6/94) y Series 300  
(después de 6/94)

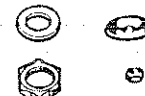

\* Check for inventory on discontinued parts. *Vea el inventario para obtener piezas discontinuadas.*

**RP320**  
**RP320MBS** (60 per case/60 por caja)  
 Diverter Assy.-1H Kitchen w/Spray  
 Ensamble del Desviador-1H Cocina con Rociador



**RP330, RP330AL, RP330BL, RP330MBS, RP330PB, RP330SB\*, RP330WH**  
 Aerator - 15/16"-27 Male Thread - 2.0 gpm @ 80psi  
 Aireador-15/16"-27 Rosca Macho-7.6L/Min @ 551 kPa



**RP334**  
 Gasket (Black)-1H Kitchen  
 Empaque (Negro)-1H Cocina



**RP391, RP391PB**  
 Trip Lever Bath Waste Assembly-Polypropylene  
 Ensamble del Desaghe/Bañera/con Palanquita de Desenganche-poliopropileno



**RP393**  
 Toe-Operated Bath Waste Assy.-Polypropylene  
 Ensamble del Desaghe/Bañera/Operado con Pie-Bañera-Poliopropileno



**RP416\***  
 Shank for Dispenser (Prior to 6/94) - 100-D/300-D/400-D  
 Espiga para el Dispersador (Antes de 6/94) - 100-D/300-D/400-D



**RP557, RP557AB, RP557PB, RP557SB\*, RP557WH**  
 Shower Cover-up Plate - Covers 8" Center Holes  
 Placa de Cubrir-para Regadera-Cubre Huecos-Centro-8"



**RP574**  
 Pressure Balance Assy.-600/1600  
 Ensamble de Balance de Presión-600/1600



**RP591** - See/Ver RP391

**RPW650HDF**  
 Shower Arm & Flange-VR  
 Brazo de la Regadera y Brida-Resistente al Maltrato



**RP691AB, RP691AL, RP691PB, RP691SB\*, RP691WH**  
 Trip Lever Bath Waste Assy.-Brass  
 Ensamble del Desaghe/Bañera/Operado con Palanquita de Desenganche-Bronce

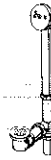

**RP693AB, RP693PB**  
 Toe-Operated Bath Waste Assy.-Brass  
 Ensamble del Desaghe/Bañera/Operado con Pie-Bronce



**RP695AB, RP695PB**  
 Lift & Turn Bath Waste Assy.-Brass  
 Ensamble del Desaghe-Bañera-Alzar y Girar-Bronce



**RP1000, RP1000AL, RP1000CB, RP1000PB, RP1000WH**  
 Soap/Lotion Dispenser Assy.  
 Ensamble del Surtidor de Jabón/Loción



**RP1058**  
 Body Screw-100/300/400  
 Tornillo del Cuerpo-100/300/400



**RP1059**  
 Base Plate-100/400  
 Placa-100/400

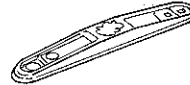

**RP1060**  
 Base Plate-300  
 Placa-300

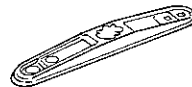

**RP1063, RP1063AL, RP1063WH**  
 Escutcheon-100/400  
 Chapetón-100/400

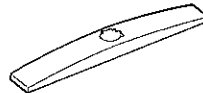

**RP1064, RP1064AL, RP1064WH**  
 Escutcheon-300  
 Chapetón-300



**RP1065\***  
 Escutcheon - 100-D/400-D (Prior to 6/94)  
 Chapetón - 100-D/400-D (Antes de 6/94)



**RP1066\***  
 Escutcheon - 300-D/400-DX (Prior to 6/94)  
 Chapetón - 300-D/400-DX (Antes de 6/94)



**RP1072** - See/Ver RP5786

**RP1076**  
 O-Ring - Spout-Need 2 for 1H Kitchen (Mfrd before 1970)-Need 1 for 600/1600  
 Anillo "O"-Tubo de Salida-Necesita 2 para 1H Cocina (Fab. antes de 1970)-Necesita 1 para 600/1600



**RPW1111HDF**  
 Personal Shower w/Bar, Wall Supply Elbow & Vacuum Breaker-2.5 gpm @ 80 psi  
 Regadera Personal con Barra, Codo Abastec. de Pared y Romedor de Vacío-9.5L/Min @ 551 kPa

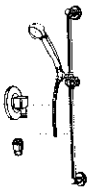

**RP1129**  
 O-Ring - Spout-NEO STYLE™, Waterfall® Kitchen  
 Anillo "O"-Tubo de Salida- NEO STYLE™, Waterfall® Cocina



**RP1181**  
 Springs-Long (Pre-1970)  
 Resortes-Largos (Pre-1970)



**RP1490\*** - See RP7407  
 Showerhead Gasket  
 Empaque para Regadera



**RP1535** - See/Ver RP116

**RP1708\***  
 Base-Square Style-4" Centerset Lav.  
 Base-Estilo Cuadrado-4" Lav de Centro

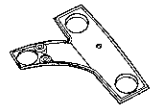

**RP1720**  
 Base Plate-2H Kitchen  
 Placa-2H Cocina

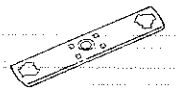

**RP1740**  
**RP1740MBS** (60 per case/60 por caja)  
 Stem Unit Assy.- 2H-SS Plate  
 Ensamble Unidad-Espiga, 2H-Placa de Acero Inoxidable



# Miscellaneous Parts/Piezas Misceláneas

**RP1745**

O-Ring for Tub Spout Adapter  
Anillo "O" para Adaptador del Tubo de Salida



**RP1748**

Slip Ring for 2100 Series Spout  
Anillo de Frotamiento para Tubo de Salida Series 2100



**RP1806**

**RP1806MBS** (240 seats per case/240 asientos por caja)  
Seats/Asientos



**RP1812** - See/Ver RP12303

**RP1930, RP1930AL, RP1930PB, RP1930WH**  
Base w/Gasket-2 1/2" Dia.-2708/2750  
Base con Empaque-2 1/2" Dia.-2708/2750

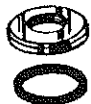

**RP1974**

Wrench-1/8" Allen-For Lever Handle Set Screw/  
All Adjusting Rings  
Llave de Turcas Allen-1/8" para Tornillo de Ajuste-Palanca/Todos los Anillos de Ajuste



**RP1991**

**RP1991MBS** (12 per case/12 por caja)  
Stem Unit Assy. w/Seats-1600  
Ensamble de la Unidad-Espiga con Asientos-1600



**RP2002**

Stud-1H 4" Centerset Lav  
Perno-1H Lav Mont. de Centro-4"



**RP2055**

O-Rings - Spout-2H Kitchen  
Anillos "O"-Tubo de Salida-2H Cocina



**RP2090**

Screwdriver/Check Stop Assy.-  
600/1600 Pressure Balance  
Destornillador/Ensamble del Tope-Series 600/1600  
Presión Balanceada



**RP2189**

Spray "Round Swivel Aerator - Fits 15/16"-27 Male Thread or 55/64"-27 Female Thread - 2.0 gpm @ 80 psi  
Rociador-Aireador Giratorio Redondo-para 15/16"-27 Rosca Macho o para 55/64"-27 Rosca Hembra-7.6L/Min @ 551 kPa



**RPW2222HDF**

Personal Shower w/Wall Bracket, Wall Supply Elbow & Vacuum Breaker-2.5 gpm @ 80 psi  
Regadera Personal con Soporte de Pared, Codo Abastec. de Pared y Rompedor de Vacío-7.6L/Min @ 551 kPa

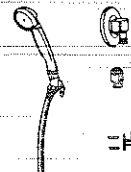

**RP2331**

O-Rings - Spout-1H Kitchen (mfrd. before 1970)  
Anillos "O"-Tubo de Salida-1H Cocina (fbdo. antes de 1970)



**RP2389**

Handle w/Button & Screw-Clear-1H Knob-Lav  
Manija con Botón y Tornillo-Transparente-1H Perilla-Lav



**RP2390**

Handle-Clear-2H Knob  
Manija-Transparente-2H Perilla



**RP2391**

Handle w/Button & Screw-Clear-1H Knob-600  
Manija con Botón y Tornillo-Transparente-1H Perilla-600



**RP2392**

Handle w/Button & Screw-Clear  
Manija con Botón y Tornillo-Transparente



**RP2393, RP2393AL, RP2393WH**

Lever Handle w/Set Screw-1H Kitchen  
Palanca con Tornillos de Ajuste-1H Cocina



**RP2411**

Button-Clear-1H Knob-Red/Blue-Gold Insert-1 3/8" dia.  
Botón-Transparente-1H Perilla-Rojo/Azul-Dorado-Inserción Dorada-1 3/8" dia.



**RP2412**

Button Set-Clear-2H Blade-3/16" dia.  
Botones-Transparente-2H Aleta-3/16" dia.



**RP2865**

Plug-Push Button Diverter 13/16"-20 - 1H T/S  
Tapón-Botón Desviador de Presión 13/16"-20 - 1H T/S



**RP2932**

Boxed Assortment Maintenance Parts Kit (5-RP61, 2-RP188, 2-RP250, 12-RP1181, 12-RP4993 plus 24 extra seats, 1-RP1974, 2-RP212, 2-RP70, 4-RP320, 6-RP25)  
Piezas Surtidas de Mantenimiento en Caja (5-RP61, 2-RP188, 2-RP250, 12-RP1181, 12-RP4993 Más 24 Asientos Extras, 1-RP1974, 2-RP212, 2-RP70, 4-RP320, 6-RP25)

**RP3016**

Stopper Seal-For Lavatory Drain Stopper  
Sello del Tapón-para Tapón de Lavamanos



**RP3135\***

End Valve Body Less Mounting Brackets-2702/2746  
Ensamble de Cuerpo Final sin Abrazaderas de Montura-2702/2746



**RP3136\***

Mounting Brackets/Abrazaderas de Montura-2702/2746



**RP3427**

**RP3427MBS** (240 springs per case/240 Resortes por caja)  
Springs/Resortes



**RP3499\***

Red/Blue Temp. Label-Rect. Escutcheon (1600 Pressure Balance)  
Etiqueta de Temp. Rojo/Azul-Chapetón Rect. (1600 Presión Balanceada)



**RP3541**

Spout Assy.-2H Laundry (Hose Thd.)  
Ensamble del Tubo de Salida-2H Lavandería (Manguera Enr.)



**RP3558**

Button-Clear-1H Knob-Arrow-Gold Insert-1 3/8" dia.  
Botón-Transparente-1H Perilla-Flecha-Inserción Dorada-1 3/8" Dia.



**RP3560\*** or See/Ver RP1991

Stem Unit Assy. w/Seats  
Ensamble de la Unidad de la Espiga con Asientos



**RP3614**

Cam Assys., O-Rings, Seats, Springs, Wrench-1H Lever or Knob  
Ensamble de la Leva, Anillos "O", Asientos, Resortes, Llave de Tuercas-1H Palanca o Perilla



**RP3616** - See/Ver RP3614

**RP3775**

Bracket for RPW2222HDF  
Abrazadera para RPW2222HDF



\* Check for inventory on discontinued parts. Vea el inventario para obtener piezas discontinuadas.

**RP3816**  
3" Diameter Hole Cover  
Cubridor de Hueco de 3" Dia.



**RP3861\***  
Spout Assy. -2576-5 1/4" Long  
Ensamble del Tubo de Salida-  
2576-5 1/4" Largo

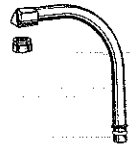

**RP3888**  
Fiberglass Mounting Bracket-(For Thin Wall T/S  
Enclosures - 602-WS)  
Soporte de Montura para Vidrio  
Fibroso-(para Paredes Delgadas de  
Compartimiento T/S - 602-WS)



**RP3913**  
Wall Supply Elbow-90° (1/2" IPS Female Inlet/  
1/2" IPS Male Outlet)  
Codo de Suministro para Pared-90°  
(1/2" IPS tubo de Admisión-Hembra/ 1/2"  
IPS Tubo de Salida-Macho)



**RP3914**  
Diverter Tub Spout for Hand Shower-for Tub Only  
Valves-4 1/2" Long (for 1/2" or 3/4" IPS)  
Tubo de Salida Desviador para Regadera de Mano-  
Solo para Válvulas de Bañera-4 1/2" Largo  
(para 1/2" o 3/4" IPS)



**RP3924**  
Repair Kit-Pulsating Hand Shower & Shower Head  
Equipo de Reparaciones-Regadera Pulsante de  
Mano y Cabeza de Regadera

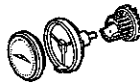

**RP4039**  
Seats & Springs Boxed Assortment Kit (12-RP1181,  
12-RP4993 plus 24 extra seats)  
Equipo de Asientos y Resortes Surtidos en Caja (12-  
RP1181, 12-RP4993 Más 24 Asientos Extras)

**RP4231\***  
Handle-Smoke-2H Knob  
Manija-Ahumado-2H Perilla



**RP4232\***  
Handle w/Button & Screw-Smoke-1H Knob  
Manija con Botón y Tornillo-Ahumado-  
1H Perilla



**RP4233\***  
Button-Smoke-1H Knob-Red/Blue-1 3/8" dia.  
Botón-Ahumado-1H Perilla-Rojo/  
Azul-1 3/8" Dia.



**RP4236\***  
Handle w/Button & Screw-Smoke-1H Knob-1600  
Manija con Botón y Tornillo-Ahumado-  
1H Perilla-1600

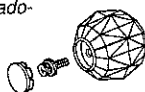

**RP4237\***  
Button-Smoke-1H Knob-1600 Series-Arrow-  
1 3/8" dia.  
Botón-Ahumado-1H Perilla-Series  
1600-Flecha-1 3/8" dia.



**RP4239**  
Shower Arm Diverter-1/2" IPS Female Inlet/  
1/2" IPS Male Outlets (not a positive shut-off)  
Desviador del Brazo de Regadera-1/2"  
IPS Tubo de Admisión-Hembra/1/2"  
IPS Tubo de Salida-Macho  
(no es cierre directo)



**RP4257, RP4257AB, RP4257AL,  
RP4257PB, RP4257SB\*, RP4257WH**  
End Valve Assy.-W/S Kitchen & Lav  
Ensamble de la Válvula Final-  
W/S Cocina y Lav



**RP4258, RP4258AB, RP4258AL, RP4258PB,  
RP4258SB\*, RP4258WH**  
End Valve Assy. w/Fitting (1/2" IPS Male  
Adapter)-W/S Kitchen & Lav  
Ensamble de la Válvula Final con Acces.  
(1/2" IPS Adaptador Macho)-  
W/S Cocina y Lavamanos



**RP4381**  
Metal Handle-2H  
Manija de Metal-2H



**RP4802\***  
Spout-Waterfall® 8" Long  
Tubo de Salida Waterfall® 8" Largo

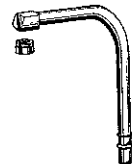

**RP4842\*** - See/Ver RP6177

**RP4972, RP4972AL, RP4972PB, RP4972WH**  
End Valve Assy.-2708/2750  
Ensamble de la Válvula Final-2708/2750



**RP4993**  
**RP4993MB** - See/Ver RP1806MBS & RP3427MBS  
Seats & Springs/Asientos y Resortes



**RP5202**  
**RP5202MBS** (60 per case/60 por caja)  
Spray Outlet-1/2 gpm Flow Control-VR -  
15/16"-27 Male Thread  
Salida-Rociador-1.9L/Min Control del Flujo-  
VR-15/16"-27 Rosca Macho



**RP5209** - See/Ver H18

**RP5210**  
Metal Handle w/VR Screw-Hot-2H/Basin  
Manija-Metal con VR Tornillo-Caliente-  
2H/Lav



**RP5211** - See/Ver RP7828

**RP5212**  
Handle w/VR Set Screw-1H Slow-Close  
Manija con VR Tornillo de Ajuste-1H Cierre Despacio



**RP5218**  
Handle-Clear-2H Roman Tub  
Manija-Transparente-2H Bañera  
Romana

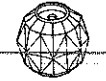

**RP5220\***  
Handle-Smoke-2H Roman Tub  
Manijas-Ahumada-2H Bañera Romana

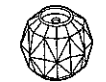

**RP5241, RP5241AL, RP5241PB,  
RP5241SB\*, RP5241WH**  
Stream Straightener - 15/16"-27 Male Thread  
Enderezador del Chorro-15/16"-27 Rosca Macho



**RP5582**  
Spout Bonnet - 711-WFHDF  
Bonete del Tubo de Salida - 711-WFHDF



**RP5645**  
Elbow Handle w/Set Screw-Red/Blue Indicators on  
End of Lever-1H Lever  
Manija Encodada con Tornillo de  
Ajuste-Indicadores Rojo/Azul al Final  
de la Palanca-1H Palanca



**RP5648, RP5648AL, RP5648PB,  
RP5648SB** (for antique brass/para bronce antiguo),  
**RP5648WH**  
Stopper-Lavatory Drain Assy.  
Tapón-Ensamble del Drenaje  
de Lavamanos

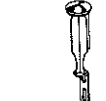

**RP5649, RP5649AB, RP5649AL, RP5649PB,  
RP5649SB\*, RP5649WH**  
Push Button Diverter Assy.-7/8" Nut - 13/16"-20 -  
1H T/S  
Desviador de Botón de Presión-7/8" Tuerca-  
13/16"-20 - 1H T/S



**RP5650, RP5650AL, RP5650PB, RP5650WH**  
Spout Assy.-8"-2H-Kitchen  
Ensamble del Tubo de Salida-8"-2H Cocina

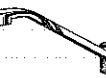

**RP5651, RP5651AB, RP5651AL, RP5651CB,  
RP5651PB, RP5651SB\*, RP5651WH**  
Metal Pop-Up Drain Assy. w/Metal Lift Knob  
Ensamble del Desagüe Automático  
de Metal con Botón-Metal-para Alzar  
el Desagüe





# Miscellaneous Parts/Piezas Misceláneas

RP5652 - See/Ver RP1000

RP5653, RP5653AL,  
RP5653GR\*, RP5653WH  
Spout Assy.-10"-1H Kitchen  
Ensamble del Tubo de Salida-  
10"-1H Cocina



RP5654, RP5654AL, RP5654WH  
Spout Assy.-8"-1H Kitchen  
Ensamble del Tubo de Salida-8"-1H Cocina



RP5692 - See/Ver RP19659

RP5693 - See/Ver RP23498

RP5785  
Nut & Wrench-Center Mount  
(101, 111, 175, 570, 575, 710, 711)  
Tuerca y Llave de Tuercas-  
Montura de Centro  
(101, 111, 175, 570, 575, 710, 711)



RP5786, RP5786AL, RP5786WH  
Base w/Gasket-Center Mount  
(101, 111, 175, 570, 575, 710, 711)  
Base con Empaque-Montura de Centro  
(101, 111, 175, 570, 575, 710, 711)



RP5833, RP5833AB, RP5833AL, RP5833PB,  
RP5833SB\*, RP5833WH  
Tub Spout-Non Diverter-4 1/2" Long-1/2" IPS  
Tubo de Salida-Sin Desviador-4 1/2" Largo-1/2" IPS



RP5834  
Tub Spout - Pull-up Diverter - 5" Long-  
1/2" IPS or 1/2" CWT  
Tubo de Salida-Desviador de Alzar-  
5" Largo-1/2" IPS o 1/2" CWT



RP5835  
Tub Spout-Non Diverter - Easy Slip-On -  
4 5/8" Long-1/2" CWT  
Tubo de Salida-Sin Desviador-Fácil Deslice-  
4 5/8" Largo-1/2" CWT



RP5836  
Tub Spout - Pull-Down Diverter - Easy Slip-On -  
5 1/4" Long-1/2" CWT  
Tubo de Salida-Desviador de Halar-Fácil Deslice-  
5 1/4" Largo-1/2" CWT



Pull-Down  
Halar Hacia  
Abajo

RP5844  
Thin Wall Shower Arm or Tub Spout Mounting Kit  
Brazo-Regadera para Pared Delgada o Herr. para  
Montura del Tubo-Salida en Bañera

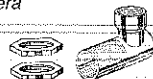

RP5845  
Thin Wall Valve Spacer w/Mounting Ells & Nuts  
Separador de Válvula/Pared Delgada con Codos  
para Montura y Tuercas



RP5846  
Thick Tile Mounting Kit-2708/2750  
Herr. para Montura en Losas Gruesas-2708/2750

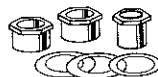

RP5847\*  
Thick Tile Mounting Kit - Old Screw-On 2710  
Herr. para Montura en Losas Gruesas-  
Atornillado Viejo-en 2710

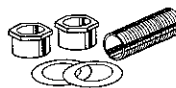

RP5855, RP5855PB  
Spout Assy.-12"-2H Kitchen  
Ensamble del Tubo de Salida-  
12"-2H Cocina



RP5857 - See/Ver RP6052

RP5859, RP5859AB, RP5859PB,  
RP5859SB\*, RP5859WH  
Flange-Lift Rod Guide (RP24)  
Brida-Guía para la Barra de Alzar (RP24)



RP5861  
Coupling Nuts-Mounting  
Tuercas de Acoplamiento-Montura



RP5863  
O-Ring - Waterfall® Spout  
Anilla "O"-Waterfall®-Tubo de Salida



RP5865, RP5865AB, RP5865PB,  
RP5865SB\*, RP5865WH  
Sleeve-Lift Rod Guide (RP24)  
Manguito-Guía para la  
Barra de Alzar (RP24)



RP5869  
Nut & Washer-Lift Rod Guide (RP24, 550 & 750)  
Tuerca y Arandela-Guía para la Barra  
de Alzar (RP24, 500 y 750)



RP5873  
Shampoo Spray & 4' Hose Assy. -  
1/4"-18 NPSM Female Swivel Nut  
Rociador de Champú y Ensamble de  
Manguera-1/4"-18 NPSM Tuerca  
Hembra Giratoria



RP5876  
Complete Screwdriver Stop-1/2" IPS-  
1H Tub/Shower except Castings  
Tope Destornillador Completo-1/2" IPS-  
1H Bañera/Regadera Excepto  
Piezas Fundidas



RP5881, RP5881WH  
Spout Assy.-4"-1H Kitchen/Lav  
Ensamble del Tubo de Salida-4"-1H Cocina/Lav



RP5883, RP5883AB, RP5883AL, RP5883PB,  
RP5883SB\*, RP5883WH  
Escutcheon/Chapetón - 600/1600



RP5885  
Screws-SS - .560"x10-24 - 2H Knob-Kitchen/Lav  
Tornillos-Acero Inoxidable-.560"x10-24-2H Perilla-  
Coc/Lav



RP5887  
Escutcheon/Sleeve-710/711  
Chapetón/Manguito-710/711



RP5890  
Gasket/Empaque - 560



RP5893, RP5893AL, RP5893PB,  
RP5893SB (for antique brass/para bronce antiguo),  
RP5893WH  
Sleeve/Manguito - 600



RP6001  
Mounting Nuts & Washers-100/400  
Tuercas de Montar y Arandelas-100/400

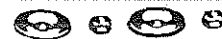

RP6005  
Complete Screwdriver Stop-1/2" CWT-1H T/S  
except Castings  
Tope Destornillador Completo-CWT  
1/2"-1H T/S Excepto con Piezas  
Fundidas



RP6008 - See/Ver RP334

\* Check for inventory on discontinued parts. Vea el inventario para obtener piezas descontinuadas.

RP6011, RP6011GR\*, RP6011RD\*  
 Spray & 4' Hose Assy. - 1/4"-18 NPSM  
 Female Swivel Nut - 1/8" NPT Male Adapter-  
 1/8" Female Stationary Nut Adapter  
 Rociador y Ens. de Manguera -  
 1/4"-18 NPSM Tuerca Hembra Giratoria-  
 1/8" NPT Adaptador Macho-  
 1/8" Tuerca Adaptadora Fija Hembra



RP6013 - See/Ver RP19362

RP6015, RP6015AC, RP6015AL, RP6015AP,  
 RP6015GR\*, RP6015PB, RP6015RD\*, RP6015WA,  
 RP6015WC, RP6015WG\*, RP6015WH, RP6015WP,  
 RP6015WR\*, RP6015WW  
 Spray Support Assy.  
 Ensamble del Soporte del Rociador



RP6017\* - See/Ver RP1000 New Design/Nuevo Diseño  
 Soap/Lotion Dispenser  
 Surtidor de Jabón/Loción



RP6019, RP6019AB, RP6019AL,  
 RP6019PB, RP6019SB\*, RP6019WH  
 Deep Escutcheon-600/1600 Series-  
 1" Deeper  
 Chapetón Hondo-Series 600/1600-  
 1" Mas Hondo



RP6023, RP6023AB, RP6023AL, RP6023PB,  
 RP6023SB\*, RP6023WH  
 Shower Arm  
 Brazo de Regadera



RP6025, RP6025AB, RP6025AL,  
 RP6025PB, RP6025SB\*, RP6025WH  
 Shower Flange  
 Brida para Regadera



RP6027\*, RP6027AL\*, RP6027PB\*, RP6027WH\*  
 Support Assy.-Soap/Lotion Dispenser-  
 Or Order RP1000  
 Ensamble del Soporte-Surtidor de Jabón/Loción  
 o orden RP1000



RP6034  
 Escutcheon-1H Kitchen-Wall Mount  
 Chapetón-1H Cocina-Montura de Pared



RP6036 - See/Ver RP19363

RP6038  
 Mounting Connectors, Washers & Nuts-  
 1H Kitchen-Wall Mount  
 Conexiones para Montar, Arandelas y Tuercas-  
 1H Cocina-Montura de Pared



RP6042, RP6042AL, RP6042GR\*,  
 RP6042RD\*, RP6042WH  
 Spout Assy.-12"-1H Kitchen  
 Ensamble del Tubo de Salida-12"-1H Cocina



RP6044  
 Slip Ring Spout-100/300/400  
 Anillo de Frot.-Tubo de Salida-100/300/400



RP6046, RP6046AB, RP6046AL, RP6046PB,  
 RP6046SB\*, RP6046WH  
 Escutcheon-Push Button Diverter-600  
 Chapetón-Desviador de Botón a Presión-  
 600



RP6048  
 O-Ring - 2H Waterfall® Kitchen & NEO STYLE™ Lav  
 Anillo "O"-2H Waterfall® Cocina y NEO STYLE™ Lav



RP6050  
 Hose-16"-2H W/S Kitchen & Lav - 1/4"-18 NPSM  
 Manguera-16"-2H W/S Cocina y Lav - 1/4"-18 NPSM



RP6052  
 Gasket/Empaque



RP6054  
 Nuts & Washers-Deck/Ledgemount/Roman Tub  
 Tuercas y Arandelas-Montura de Bordes/  
 Bañera Romana



RP6056  
 Nut & Washer-Spout - High-Rise Widespread  
 Tuerca y Arandela-Tubo de Salida-  
 Alto y Extendido



RP6060  
 RP6060SB (for antique/polished brass/para bronce  
 antiguo y pulido)  
 Bonnet Nuts-2H Kitchen/Lav  
 Bonetes/Capuchones-2H Cocina/Lav



RP6062 - See/Ver H28

RP6064  
 RP6064SB (for antique/polished brass/para bronce  
 antiguo y pulido)  
 Locknuts-2H Kitchen/Lav  
 Contratuercas-2H Cocina/Lav



RP6066, RP6066PB\*  
 Escutcheon/Chapetón - 2100/2400



RP6068, RP6068PB  
 Button-Plug-2H Lav Escutcheon  
 Botón-Tapón-2H Chapetón Lav



RP6070, RP6070AL, RP6070PB, RP6070WH  
 Spout Nut-2100/2400  
 Tuerca del Tubo de Salida-2100/1400



RP6073  
 RP6073MBS (30 per case/30 por caja)  
 Diverter Assy.-2H Kitchen w/Spray  
 Ensamble del Desviador-2H Cocina  
 con Rociador



RP6075  
 Gasket/Empaque - 120/420/2100/2400



RP6077\* - See/Ver RP6011

RP6079\*, RP6079AB\*, RP6079SB\*, RP6079WH\*  
 Bonnet/Capuchón - 1600



RP6081\*, RP6081PB\*, RP6081SB\*, RP6081WH\*  
 Sleeve/Manguito - 1600



RP6083\*, RP6083AB\*, RP6083PB\*, RP6083SB\*,  
 RP6083WH\*  
 Escutcheon/Chapetón - 1600

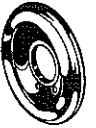

RP6085\* - See/Ver RP6015AC

RP6087  
 Nut & Washer-Spout-Widespread Lav  
 Tuerca y Arandela-Tubo de Salida-Lav. Extendido



RP6089, RP6089AB, RP6089AL, RP6089PB,  
 RP6089SB\*, RP6089WH  
 Base w/Gasket-Spout-3504/3523/3524-  
 1"-ID/2" OD (not threaded)  
 Base con Empaque-Tubo de Salida-  
 3504/3523/3524-1" ID/2" OD  
 (no enroscado)



# Miscellaneous Parts/Piezas Misceláneas

**RP6092**  
Nuts & Washers-500  
Tuercas y Arandelas

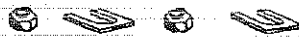

**RP6097, RP6097AB, RP6097AL, RP6097CB, RP6097PB, RP6097SB\*, RP6097WH**  
Spout Assy. w/Lift Rod Hole - D-Shape - 3523/3524  
Ensamble del Tubo de Salida con Hueco para la Barra de Alzar-en-Forma D - 3523/3524

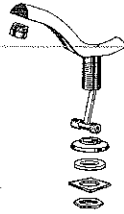

**RP6100, RP6100AL, RP6100PB, RP6100SB** (for antique brass/para bronce antiguo), **RP6100WH**  
Aerator - 55/64"-27 Male Thread - Bar/Spray 'Round' - 2.0 gpm @ 80 psi  
Aireador-55/64"-27 Rosca Macho-Bar/Rociador Redondo-7.6L/Min @ 551 kPa



**RP6103**  
Spout Assy. Less Lift Rod Hole - D-Shape - 3504  
Ensamble del Tubo de Salida Sin Hueco para la Barra de Alzar-en-Forma D-3504

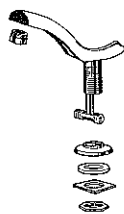

**RP6107\*, RP6107AB\***  
Escutcheon-Push Button Diverter-1600  
Chapetón-Desviador de Botón de Presión-1600



**RP6113** - See/Ver RP19659

**RP6117\***  
Handle w/Screw-Blade-VR-1600  
Manija con Tornillo-Aleta-VR-1600

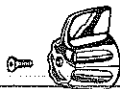

**RP6119**  
Screw-Blade Handle-VR-1300/1400/1600  
Tornillo-Manija con Aleta-VR-1300/1400/1600



**RP6122**  
Showerhead-2.5 gpm @ 80 psi  
Cabeza de Regadera-9.5L/Min @ 551 kPa

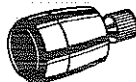

**RP6124, RP6124AB, RP6124PB, RP6124SB\***  
Adjustable Volume Control-  
(For Shower Arm Installation)  
Control Ajustable de Volumen-  
(Para Instalación de Brazo de Reg.)



**RP6126, RP6126AB, RP6126AL, RP6126PB, RP6126SB\*, RP6126WH**  
Flange - Pop-Up Drain Assy.  
Brida-Ensamble del Desaghe Automático



**RP6128**  
Tailpiece - Pop-Up Drain Assy.  
Tubo de Cola-Ensamble del Desaghe Automático



**RP6130**  
Pivot Seat & Gasket - Pop-Up Drain Assy.  
Asiento Pivotado y Empaque-  
Ensamble del Desaghe Automático



**RP6132**  
Nut - Pop-Up Drain Assy.  
Tuerca-Ensamble del  
Desaghe Automático



**RP6134\*** - See/Ver RP12516 & RP12517

**RP6138\*** - See/Ver RP6146

**RP6140**  
Nut & Washer - Pop-Up Drain Assy.  
Tuerca y Arandela-Ensamble  
del Desaghe Automático



**RP6142**  
Gasket - Pop-Up Drain Assy.  
Empaque-Ensamble del Desaghe Automático



**RP6146, RP6146AL, RP6146PB, RP6146SB** (for antique brass/para bronce antiguo), **RP6146WH**  
Knob & Rod Assy.  
Ensamble de la Barra del Desaghe con Botón



**RP6148\***  
Escutcheon-Elliptical-3H T/S  
Chapetón-Eliptico-3H T/S

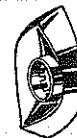

**RP6150, RP6150AB, RP6150PB, RP6150SB\***  
Escutcheon-4" Dia.-Square-2702/2714/2746  
Chapetón-4" Dia.-Cuadrado-  
2702/2714/2746



**RP6152, RP6152AB, RP6152AC, RP6152AL, RP6152CB, RP6152PB, RP6152SB\*, RP6152WC, RP6152WH, RP6152WP**  
Pulsating Showerhead-Brass-2.5 gpm @ 80 psi  
Cabeza de Regadera Pulsante-  
Bronce-9.5L/Min @ 551 kPa

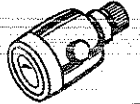

**RP6154\***  
Venturi/Venturi - 2702/2746



**RP6156**  
Tee/"T" - 2714



**RP6158\***  
Cross w/Venturi-2702/2746  
Cruz con Venturi-2702/2746



**RP6162**  
Shower Arm-Thin Wall Tub Enclosures-2746  
Brazo de Regadera-Compartimientos de Bañera  
con Pared Delgada-2746

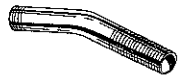

**RP6164**  
Screws/Tornillos - 2702/2708/2746/2750



**RP6166**  
Brackets/Soportes - 2702/2714/2746



**RP6170\*** - See/Ver RP5241

**RP6172** - See/Ver RP17713

**RP6174**  
Tee/"T" - 1/4"x1/4"x1/4" CWT - 2708/2750



**RP6177, RP6177PB, RP6177SB** (for antique brass/para bronce antiguo)  
Sleeve Assy.-2702/2714/2746  
Ensamble del Manguito-2702/2714/2746

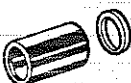

\*Check for inventory on discontinued parts. Vea el inventario para obtener piezas discontinuados.

**RP6179**  
Thin Wall Mount Nuts  
Tuercas de Montura de Pared Delgada



**RP6181**  
Thin Wall Mount Washers  
Arandelas de Montura de Pared Delgada



**RP6183**  
Locknuts-Mounting-2H  
Contratuercas-Montura-2H



**RP6185**  
Screwdriver Stop Assy.-For T/S Models w/Stops  
(Casting)  
Ensamble del Tope Destornillador-Para Modelos T/S  
con Topes (Fundidos)



**RP6187**  
Reducers/Reductores - 1/4" CWT x 1/2" CWT



**RP6189**  
Spout Assy.-Laundry  
Ensamble del Tubo de Salida-  
Lavandería



**RP6191\***  
Ejector-2H T/S (Casting)  
Ejector-2H T/S (Fundido)



**RP6193, RP6193AB, RP6193AL,  
RP6193PB, RP6193SB\*, RP6193WH**  
Escutcheon-2170/2172/Laundry/2576  
Chapetón-2170/2172/Lavandería/2576



**RP6195**  
Undercover Plate-2170/2172/Laundry/2576  
Placa-2170/2172/Lavandería/2576



**RP6197**  
**RP6197AB\*** - See/Ver RP22664AB  
**RP6197AL\*** - See/Ver RP22664AL  
**RP6197PB\*** - See/Ver RP22664PB  
**RP6197SB\***  
**RP6197WH\*** - See/Ver RP22664WH  
Bonnet-Spout-2H Bar/Laundry  
Capuchón-Tubo de Salida-  
2H Bar/Lavandería



**RP6199, RP6199AB, RP6199AC, RP6199AL,  
RP6199AP, RP6199CB, RP6199PB, RP6199WC,  
RP6199WH, RP6199WP**  
Spout Assy.-2H Bar except 2171  
Ensamble del Tubo de Salida-  
2H Bar Excepto 2171



**RP6201**  
Spout Retaining Ring-Laundry  
Anillo de Retención del  
Tubo de Salida-Lavandería



**RP6203**  
Coupling Nuts & Tailpieces-2/3H T/S  
Tuercas de Acoplamiento y  
Tubos de Cola-2/3H T/S

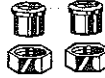

**RP6205\***  
Escutcheon-Rectangular-Red/Blue Label-1600/1700  
Pres. Bal. Series  
Chapetón-Rectangular-Etiqueta  
Roja/Azul-Series de Pres. Bal.-  
1600/1700

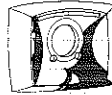

**RP6207\***  
Escutcheon-Rectangular-Vol. Control-Red/Blue  
Label-1800 Pres. Bal. Series  
Chapetón-Rectangular-Etiqueta  
Roja/Azul-Series de Pres. Bal. 1800

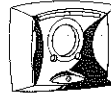

**RP6209\***  
Volume Control Stem Assy.-1800  
Ensamble de la Unidad del Vástago  
de Control Volumen-1800

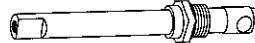

**RP6212**  
Showerhead-Adj. Volume Control-2.5 gpm @ 80 psi  
Cabeza de Regadera-Control de Vol. Adj.-  
9.5L/Min @ 551 kPa

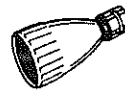

**RP6218**  
Pulsating Showerhead - Non-Metallic -  
2.5 gpm @ 80 psi  
Cabeza de Regadera Pulsante-No  
Metálica-9.5L/Min @ 551 kPa

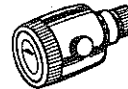

**RP6222** - See/Ver RP17712

**RP6225, RP6225AL, RP6225PB, RP6225WH**  
Bonnet-Spout-2H Waterfall®  
Capuchón-Tubo de Salida-2H Waterfall®



**RP6227**  
Retaining Ring-Spout-Waterfall®  
Anillo de Retención-Tubo de Salida-  
Waterfall®



**RP6233\***  
Base-1H Lav-Square Style Esc.  
Base-1H Lav-Chapetón Estilo Cuadrado



**RP6235\*, RP6235PB\***  
Undercover Plate w/Screws-1H Lav-  
Square Style Esc.  
Placa con Tornillos-1H Lav-  
Chapetón Estilo Cuadrado



**RP6237\***  
Handles w/Buttons & Screws-Smoke-2H  
Manijas con Botones y Tornillos-  
Ahumado-2H

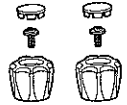

**RP6243\***  
Gasket-Spout (RP6309/RP6363)  
Empaque-Tubo de Salida  
(RP6309/RP6363)



**RP6286\***  
Escutcheon-Rectangular-Red/Blue Label-  
Push Button Div.-1600 Pres. Bal. Series  
Chapetón-Rectangular-Etiqueta  
Roja/Azul-Desviador de  
Botón de Presión-Series de  
Presión Balanceada 1600



**RP6303** - See/Ver RP6152AB

**RP6309\*, RP6309AB\*, RP6309PB\*, RP6309SB\***  
Spout Assy.-2H W/S - See RP18417  
Ensamble del Tubo de Salida-2H  
W/S-Ver RP18417

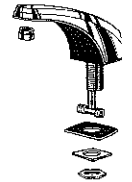

**RP6313** - See/Ver RP5648SB

**RP6315**  
Mounting Nut & Washer - 300-D  
Tuercas de Montura y Arandela - 300-D



**RP6328\***  
Escutcheon-2H Kitchen Waterfall®  
Chapetón-2H Cocina Waterfall®



**RP6331\*, RP6331AL\*, RP6331WH\***  
Escutcheon-1H Waterfall®  
Chapetón-1H Waterfall®



# Miscellaneous Parts/Piezas Misceláneas

**RP6333\***  
Body Assy.-3576  
Ensamble del Cuerpo-3576



**RP6369**  
Screw-SS - 10-24x.460" - Handle  
Tornillos-Aceros de Inoxidable - 10-24x.460" - Manija



**RP6399**  
Stem Assy. - Slow Self-Close  
Ensamble de la Espiga-Cierre Lento Automático



**RP6335** - See/Ver RP6011

**RP6337\***  
Base & Gasket for Old 1H Waterfall® Handle-Base  
Base y Empaque para Base de Manija Viejo 1H Waterfall®



**RP6375**  
Set Screw-Slow Close Handle/2767  
Tornillo de Ajuste-Manija de Cierre Lento/2767



**RP6401**  
Handle Screw - 10-24x13/16" - VR  
Tornillo de Manija - 10-24x13/16" - Resistente al Maltrato



**RP6339**  
Rotary Stopper Assy.  
Ensamble del Tapón Giratorio



**RP6377**  
Button Set-VR Handle-Metal-1 5/16" Diameter  
Botones-Manija de Resistente al Maltrato/Metálico-1 5/16" Dia.



**RP6403, RP6403AB, RP6403AL, RP6403PB, RP6403SB\*, RP6403WH**  
Overflow Plate Assy.-(Includes Detent Spring, Overflow Plate & Lever) for RP291/RP391/RP691  
Ensamble-Placa de Desborde-Ensamble del Desaghe de Bañera para RP291/RP391/RP691

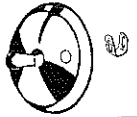

**RP6341**  
Teel/"T" - 2H W/S Waterfall®



**RP6379**  
Handle Screws - 10-24x1 9/16" - VR  
Tornillos de Manija - 10-24x1 9/16" - Resistente al Maltrato



**RP6404, RP6404AB, RP6404AL, RP6404PB, RP6404SB\*, RP6404WH**  
Screws - Overflow Plate - 1 3/4"x1/4"-20  
All Bath Waste Drain Assys.  
Tornillos-Placa de Desborde-1 3/4"x1/4"-20  
Ensamble de Desaghe de Bañera



**RP6344\***  
Flange-Grid Strainer  
Brida-Colador de Rejilla



**RP6383\***  
Base - Screw-On Roman Tub Spout  
Base-Tubo de Salida Atornillable para Bañera Romana



**RP6409** - See/Ver RP18300 (2 1/2") or RP18543 (3")

**RP6346**  
Grid Strainer Assy.  
Ensamble del Colador de Rejilla



**RP6385\***  
Gasket - Screw-On Roman Tub Spout  
Empaque-Tubo de Salida Atornillable para Bañera Romana



**RP6411\***  
Tee- 1/2" x 1/2" x 3/4" IPS - Screw-On Roman Tub Spout  
"T"-1/2"x1/2"x3/4" IPS-Atornillable-para Tubo de Salida de Bañera Romana

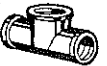

**RP6350**  
Cap-Recessed-Push Button Diverter-2H T/S  
Tapa-Ahuecada-Desviador de Botón de Presión-2H T/S



**RP6387\***  
Nipple - Screw-On Roman Tub Spout  
Entrerrosca-Tubo de Salida Atornillable para Bañera Romana



**RP6413\***  
Adapter-1/2" IPS x 3/8" Comp. - Screw-On Roman Tub Spout  
Adaptador-1/2" IPS x 3/8"-Atornillable Tubo de Salida para Bañera Romana



**RP6354**  
Rotary Stopper  
Tapón Giratorio



**RP6389\***  
Nut & Washer - Screw-On Roman Tub Spout  
Tuerca y Arandela-Tubo de Salida Atornillable para Bañera Romana



**RP6417**  
Gasket-End Valve-RT/Transfer  
Empaque-Válvula Final-RT/Tras.



**RP6359**  
Push Button Diverter w/Recessed Cap-2H T/S  
Desviador de Botón de Presión con Tapa Ahuecada-2H T/S

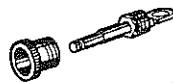

**RP6391\*, RP6391AB\*, RP6391PB\*, RP6391SB\***  
Spout Assy. - Slip-On Plug in Front - Roman Tub  
Ensamble de Salida-Tapón Deslizable de Frente-Bañera Romana

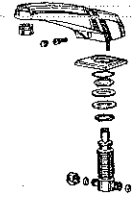

**RP6420**  
Wrench-Metal-for VR Aerator/Spray Outlet  
Llave de Tuerca-Metálico-para Aireador de Resistente al Maltrato/Salida del Rociador



**RP6363\*** - See/Ver RP17712

**RP6393** - See/Ver RP5241SB

**RP6365**  
O-Ring - Bar/Laundry/Slip-On Diverter Tub Spouts  
Anillo "O"-Bar/Lavandería/Tubos de Salidas para Bañera de Desviador Deslice



**RP6397**  
Bonnet Nut - Slow Self-Close Faucets  
Capuchón-Llaves de Cierre Lento Automático



**RP6452** - See/Ver RP334



\*Check for inventory on discontinued parts. Vea el inventario para obtener piezas discontinuados.

See page 115 for abbreviations & suffixes.

**RP6456**  
Adapter - 13/16"-27 Male x 15/16"-27 Female Thread  
Adaptador-13/16"-27 Macho x 15/16"-27  
Rosca Hembra



**RP6463**  
Snap 'N Pop-Up® Drain Assy. - Non-Metallic  
Ensamble del Drenaje Automático  
Snap 'N Pop-UP® - No Metálico

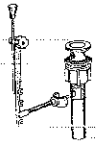

**RP6475**  
Nut for RP6463  
Tuerca para RP6463



**RP6477**  
Pivot Rod & Strap Assy. for RP6463  
Barra Pivotada y Ensamble Barra  
Chata-para RP6463

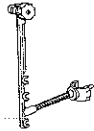

**RP6481**  
O-Ring for RP6463  
Anillo "O" para RP6463



**RP6573** - See/Ver RP1000

**RP6638**  
Cotter Pin for RP291/RP391/RP691  
Chaveta para RP291/RP391/RP691

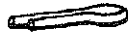

**RP6639**  
Detent Spring for RP291/RP391/RP691  
Resorte Retenedor para RP291/RP391/RP691



**RP6641**  
Drain Ell for RP691/RP695  
Drenaje Acodado para RP691/RP695

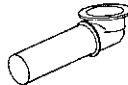

**RP6876**  
Foam Gasket for RP6463  
Empaque de Goma para RP6463

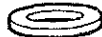

**RP6893**  
Mounting Bracket (101/175/570/575/710/711)  
Soporte de Montura  
(101/175/570/575/710/711)



**RP6894** - See/Ver RP12691

**RP7130**  
Mounting Nuts & Washers-2H Slow Close  
Tuercas y Arandelas de Montura-2H Cierre Lento



**RP7131**  
Mounting Spacers-2H Slow Close  
Separadores para Montura-2H Cierre Lento



**RP7132**  
Handle w/Set Screw-Hot-Slow Close  
Manija con Tornillo de Ajuste-Caliente-  
Cierre Lento



**RP7133**  
Handle w/Set Screw-Cold-Slow Close  
Manija con Tornillo de Ajuste-Fría-  
Cierre Lento



**RP7245**  
Personal Shower w/Bar-2.5 gpm @ 80 psi  
Regadera Personal con Barra-  
9.5L/Min @ 551 kPa



**RP7404**  
Wrist Blade Handle w/Screw  
Tipo de Aleta con Tornillo

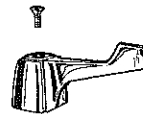

**RP7405**  
Hand Shower Assy.-Personal Shower w/Push Button  
On-Off Control - Not a Positive Shut-Off -  
2.5 gpm @ 80 psi  
Ensamble de Regadera de Mano-  
Regadera Personal con Control de  
Cerrar/Abrir de Botón de Presión-  
No un Cierre Directo-2.5 gpm @ 80 psi

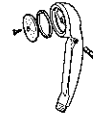

**RP7406**  
Shower Bracket-Personal Shower  
Soporte de Regadera-Regadera Personal



**RP7407**  
Gasket (Same as RP1490)-Personal Shower  
Empaque (Igual que RP1490)-Regadera Personal



**RP7408**  
Wall Bar Assy. w/Slide-Personal Shower  
Ensamble de la Barra de Pared  
con Corredera-Regadera Personal



**RP7409**  
Hose-60"-Personal Shower  
Manguera-60"-Regadera Personal



**RP7410**  
Overflow Ell for RP391/RP393  
Codo de Desborde-Ensamble del Drenaje  
de Bañera

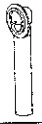

**RP7414**  
Tee for RP391/RP393  
"T" para RP391/RP393

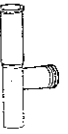

**RP7416**  
Drain Ell for RP391/RP393  
Drenaje Acodado-Ensamble del Drenaje de Bañera  
para RP391/RP393

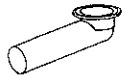

**RP7418**  
Waste Plug & Drain Ell for RP391 -  
1 1/2"-11 1/2 NPSM  
Tapón del Desagüe-Ensamble  
del Drenaje de Bañera para RP391 -  
1 1/2"-11 1/2 NPSM

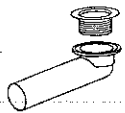

**RP7419** - See/Ver RP7430

**RP7420**  
Beveled Gasket-All Bath Waste Drain Assys.  
Empaque Biselado



**RP7421**  
Coupling Nuts & Gaskets for RP391/RP393  
Tuercas de Acoplamiento y Empaques-Ensamble  
del Drenaje de Bañera para RP391/RP393



**RP7423** - See/Ver RP7900

**RP7424, RP7424AB, RP7424PB, RP7424SB\***  
Overflow Plate Assy. for  
RP293/RP393/RP693/RP695  
Ensamble de la Placa de Desborde-  
Ensamble del Drenaje de Bañera para  
RP293/RP393/RP693/RP695



**RP7426AB, RP7426PB, RP7426SB\***  
Stopper Assy. for RP695 - 10-24 Threads  
Ensamble del Tapón-Ensamble del Drenaje  
de Bañera - 10-24 Roscas



**RP7428, RP7428AL, RP7428PB,  
RP7428SB (for antique brass/para bronce antiguo),  
RP7428WH**  
Dome Strainer Screw for RP291/RP391/  
RP691 - 10-24x1 3/4"  
Tornillo-Ensamble del Drenaje de Bañera  
para RP291/RP391/RP691 - 10-24x 1 3/4"



**RP7430, RP7430AB, RP7430AL,  
RP7430PB, RP7430SB\*, RP7430WH**  
Dome Strainer w/Screw for RP291/RP391/RP691  
Colador-Forma de Cúpula-con  
Tornillo-Ensamble del Drenaje de  
Bañera para RP291/RP391/RP691



# Miscellaneous Parts/Piezas Misceláneas

**RP7432**  
Waste Plug for RP291/RP691 - 1 5/8"-16  
Tapón del Desagüe para RP291/RP691 - 1 5/8"-16



**RP7435**  
Tub Tacks for RP391/RP393  
Tachuelas para Bañeras para RP391/RP393



**RP7439**  
Retainer Screws for RP291/RP293/RP691/RP693/RP695 - 10-24x1 3/4"  
Tornillos de Retención para RP291/RP293/RP691/RP693/RP695 - 10-24x1 3/4"



**RP7441**  
Tailpiece for RP691/RP693  
Tubo de Cola para RP691/RP693



**RP7445PB**  
**RP7445SB** (for antique brass/para bronce antiguo)  
Waste Plug for RP695 - 1 5/8"-16  
Tapón del Desagüe para RP695 - 1 5/8"-16



**RP7448\*, RP7448PB\***  
Adapter w/O-Ring - 2H W/S Kitchen Waterfall® w/Diverter  
Adaptador con Anillo "O"-2H W/S Cocina Waterfall® con Desviador



**RP7449**  
O-Ring - 2H W/S Kitchen Waterfall® w/Diverter  
Anillo "O"-2H W/S Cocina Waterfall® con Desviador



**RP7450\*, RP7450PB\***  
Body Assy.-2H W/S Kitchen Waterfall® w/Diverter  
Ensamble del Cuerpo-2H W/S Cocina Waterfall® con Desviador



**RP7451\*, RP7451AL\*, RP7451PB\*, RP7451WH\***  
Body Assy.-2H W/S Kitchen Waterfall® w/o Diverter  
Ensamble del Cuerpo-2H W/S Cocina Waterfall® sin Desviador



**RP7457**  
Spout Assy.-710/3579  
Ensamble del Tubo de Salida-710/3579

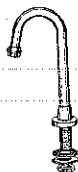

**RP7461**  
Escutcheon/Chapetón - 120/420



**RP7462**  
Snap Ring-120/420  
Aro de Resorte-120/420



**RP7524, RP7524PB, RP7524SB** (for antique brass/para bronce antiguo)  
Knob & Rod Assy.-Clear Lift Knob  
Ensamble de la Perilla y Barra- Botón de Alzar Transparente



**RP7526\*, RP7526PB\*, RP7526SB\***  
Pop-Up Drain Assy.-Metal-Clear Lift Knob  
Ensamble de Desagüe Automática/ Metálico-/Botón de Alzar Transparente

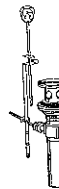

**RP7527, RP7527AL, RP7527PB, RP7527SB** (for antique brass/para bronce antiguo),  
**RP7527WH**  
Screws-For Lever-2H - 10-24x1 1/4"  
Tornillos-para Palanca-2H - 10-24x1 1/4"



**RP7528\*** - See/Ver H22 & A22CL  
**RP7528AB\*** - See/Ver H22AB & A22CL  
**RP7528PB\*** - See/Ver H22PB & A22CL  
**RP7528SB\***

**RP7533, RP7533AB, RP7533AL, RP7533CB, RP7533PB, RP7533SB\*, RP7533WH**  
Tub Spout - Pull-Up Diverter - 1/2" CWT or IPS-5" Long  
Tubo de Salida para Bañera- Botón Desviador de Alzar- 1/2" CWT o IPS-5" Largo



**RP7534** - See/Ver RP18396

**RP7536**  
O-Rings (If for 2167/2467/2474-order new spout)  
Anillos "O" (Para 2167/2467/2474-orden tubo de salida nuevo)



**RP7537\***  
Adapter w/O-Ring - Old Square Style 2714 Spout  
Adaptador con Anillo "O"-Tubo de Salida de Estilo Cuadrado Viejo 2714

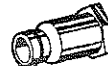

**RP7577\*, RP7577AB\*, RP7577PB\***  
Escutcheon - Non-Pressure Balance 1600  
Chapetón sin Presión Balanceada 1600



**RP7578\*, RP7578AB\***  
Escutcheon - Push-Button Diverter - Non-Pressure Balance 1600  
Chapetón-Desviador del Botón Pulsador-sin Presión Balanceada 1600



**RP7579\***  
Escutcheon - Non-Pressure Balance 1600/1700  
Chapetón-Sin Presión Balanceada 1600/1700

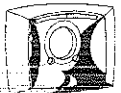

**RP7580\***  
Escutcheon - Push-Button Diverter - Non-Pressure Balance 1600-Red/Blue Label  
Chapetón-Desviador de Botón Pulsador-sin Presión Balanceada 1600-Etiqueta Rojo/Azul

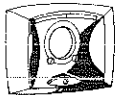

**RP7581\***  
Escutcheon - Non-Pressure Balance 1800-Vol. Control-Red/Blue Label  
Chapetón-sin Presión Balanceada 1800-Etiqueta Rojo/Azul

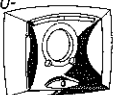

**RP7582\***  
Escutcheon - Non-Pressure Balance 900-Antique Brass  
Chapetón-sin Presión Balanceada 900-Bronce Antiguo

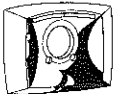

**RP7584**  
Chain & Stopper  
Cadena y Tapón



**RP7585**  
Extender-For RP6463 Pop-Up Drain Assy.  
Extension-Para RP6463 Ensamble de Desagüe Automático

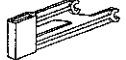

**RP7828**  
Metal Handle w/VR Screw-Cold-2H/Basin  
Manija de Metálico con Tornillo de Resistente al Maltrato-Frío-2H Lav



**RP7893AB** - See/Ver RP5833AB  
**RP7893PB** - See/Ver RP5833PB

**RP7895**  
Clevis for RP291/RP391/RP691  
Barra con Horquilla para RP291/RP391/RP691



**RP7896**  
Plunger Assy. for RP291/RP691  
Ensamble del Chupón para RP291/RP691



**RP7897**  
Tailpiece for RP291/RP293  
Tubo de Cola para RP291/RP293



\* Check for inventory on discontinued parts. Vea el inventario para obtener piezas discontinuadas.

**RP7898**  
Retainer Wire for  
RP291/RP293/RP691/RP693/RP695  
Alambre Retenedor para  
RP291/RP293/RP691/RP693/RP695



**RP7899**  
Overflow Ell for RP291/RP293  
Desborde Acodado para RP291/RP293



**RP7900**  
Gasket-All Bath Waste Drain Assys.  
Empaque-Para Todo Ensambls de Desaghe  
de la Bañera Drenaje



**RP7901**  
Drain Ell for RP291  
Drenaje Acodado para RP291



**RP7902**  
Tee/T"  
for RP291/RP293/RP691/RP693/RP695

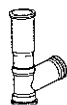

**RP7903**  
Coupling Nuts & Gaskets for  
RP291/RP293/RP691/RP693/RP695  
Tuercas de Acoplamiento y Empaques para  
RP291/RP293/RP691/  
RP693/RP695



**RP7904**  
Plunger Assy. for RP391  
Ensamble del Chupón para RP391

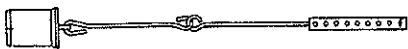

**RP7908, RP7908AL\*, RP7908CB\*, RP7908PB\*,  
RP7908WH\***  
Spout Assy.-Waterfall® (except 2474)-9 1/2" Long  
Ensamble del Tubo de Salida del  
Agua-Waterfall® (excepto 2474)-  
9 1/2" Largo

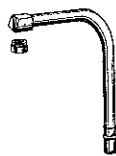

**RP8075\***  
Seat Bolts-Delta Water Closet  
Pernos de Asiento-Inodoro de Delta



**RP8076** - See/Ver RP16309

**RP8077\***  
Arm & Float-Delta Water Closet  
Brazo y Flotador-Inodoro de Delta

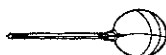

**RP8084\***  
Tank Lid-Bone-Delta Water Closet  
Tapa del Tanque-Color Marfil-Inodoro de Delta



**RP8087\***  
Mounting Bolt Covers-White-Delta Water Closet  
Cubridores de Pernos de Montar-Blancos-  
Inodoro de Delta



**RP8088\***  
Mounting Bolt Covers-Bone-Delta Water Closet  
Cubridores de Pernos de Montar-Blancos-  
Inodoro de Delta

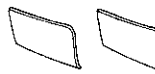

**RP8090\***  
Hose w/Clamps-Delta Water Closet  
Manguera y Mordaza-Inodoro de Delta



**RP8091\***  
Flapper & Chain-Delta Water Closet  
Tapón y Cadena-Inodoro de Delta



**RP8092\***  
Flush Valve Assy.-Delta Water Closet  
Ensamble de la Válvula de Bajar Agua-  
Inodoro de Delta



**RP8230**  
**RP8230MBS** (30 per case/30 por caja)  
Ceramic Stem Unit, Seat, O-Ring,  
Spring & Screw-2H  
Unidad de la Espiga de Cerámica,  
Asiento, Anillo "O", Resorte y Tornillo-2H

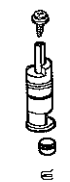

**RP8252PB**  
Tub/Shower Special Finish Trim Kit-Non Push Button  
Diverter 600/1600  
Equipo de Accesorios Especiales de  
Acabados para Regadera/Bañera-  
No Botón de Desviador Pulsador  
600/1600



**RP8574\***  
Tank Lid-Antique Red-Delta Water Closet  
Tapa del Tanque-Rojo Antiguo-Inodoro de Delta



**RP8575\***  
Mounting Bolt Covers-Antique Red-  
Delta Water Closet  
Cubridores de Pernos de Montar-  
Rojo Antiguo-Inodoro de Delta



**RP8655**  
SS Liner Repair Kit  
Equipo de Reparación de Forro de Acero Inoxidable

**RP9469\*, RP9469AB\*, RP9469PB\*, RP9469SB\***  
Trip Lever Assy.-Delta Water Closet  
(replaces push button assy.)  
Ensamble de la Palanquita de  
Desenganche-Inodoro de Delta



**RP9489\***  
Seat w/Bolts-Elongated-White-Delta Water Closet  
Asiento con Pernos-Alargados-  
Blancos-Inodoro de Delta



**RP9490\***  
Seat w/Bolts-Elongated-Bone-Delta Water Closet  
Asiento con Pernos-Alargados-Color  
Marfil-Inodoro de Delta

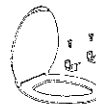

**RP9492\***  
Seat w/Bolts-Elongated-Antique Red-  
Delta Water Closet  
Asiento con Pernos-Alargados-Rojo  
Antiguo-Inodoro de Delta



**RP9519**  
Mounting Nuts & Washers-W/S  
Tuercas y Arandelas de  
Monturas-W/S



**RP9595, RP9595AB, RP9595PB, RP9595SB\***  
Trip Lever Assy.-For Most 2 Piece Water Closets  
Ensamble de la Palanquita de Desenganche-Para  
Casi Todos los Inodoros de Dos  
Piezas



**RP9633**  
Spout Assy.-6"-1H Kitchen  
Ensamble del Tubo de Salida del  
Agua-6"-1H Cocina



**RP9758**  
Plasterguard-2/3H T/S  
Protector de Enlucido-2/3H T/S



**RP9799\***  
Seat w/Bolts-Elongated-Open Front w/Cover-White-  
Delta Water Closet  
Asientos con Pernos-Alargados-Frente  
Abierto con Tapa de Cubrir-Blanco-  
Inodoro de Delta

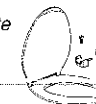

**RP9946**  
Nut & Set Screw - Slip-On Diverter Tub Spouts  
Tuercas y Tornillo de Ajuste-Tubo de  
Salida para Bañera Deslice



**RP10089, RP10089AB, RP10089PB,  
RP10089SB\*, RP10089WH**  
Rosette Spray-Bidet  
Rociador-Bidé





# Miscellaneous Parts/Piezas Misceláneas

**RP10092, RP10092AB, RP10092PB, RP10092SB\*, RP10092WH**  
Base w/Gasket-Bidet-2" Diameter  
Base con Empaque-Bidé-2" Dia.



**RP10093**  
Directional Valve Assy.-Bidet w/  
Vacuum Breaker  
Ensamble Direccional de la Válvula-Bidé  
o/Romp. de Vacío



**RP10094**  
Supply Tube-Bidet  
Tubo de Abastecimiento-Bidé



**RP10095**  
Nut & Gasket-Bidet  
Tuerca y Empaque-Bidé



**RP10097, RP10097AB, RP10097PB**  
End Valve Assy.-Bidet w/o Vacuum Breaker  
Ensamble de la Válvula Final-Bidé sin Romp.  
de Vacío



**RP10098**  
Coupling Nuts-Mounting-Bidet  
Tuercas de Acoplamiento-Montura-Bidé



**RP10099**  
Directional Valve Assy.-Bidet w/o Vacuum Breaker  
Ensamble de la Válvula Direccional-Bidé sin  
Romp. de Vacío



**RP10105** - See/Ver RP6150

**RP10107ABOAK\*** - See/Ver H22AB & A22OK  
**RP10107ABPOR\*** - See/Ver H22AB & A22PR  
**RP10107ABROS\*** - See/Ver H22AB & A22RS  
**RP10107OAK\*** - See/Ver H22 & A22OK  
**RP10107PBOAK\*** - See/Ver H22PB & A22OK  
**RP10107PBPOR\*** - See/Ver H22PB & A22PR  
**RP10107POR\*** - See/Ver H22 & A22PR  
**RP10107ROS\*** - See/Ver H22 & A22RS  
**RP10107SBPOR\***

**RP10108OAK, RP10108PBOAK, RP10108PBPOR, RP10108POR, RP10108ROS, RP10108SBOAK** (for antique brass/para bronce antiguo), **RP10108SBPOR** (for antique brass/para bronce antiguo), **RP10108SBROS** (for antique brass/para bronce antiguo)  
Knob & Lift Rod Assy.  
Ensamble de Barra de Alzar



**RP10207** - See/Ver H21

**RP10208**  
Button Set/Botones - 7/8" Dia.



**RP10388**  
Arrow Button/Boton con Flecha - 7/8" Dia.



**RP10612**  
Thick Tile Mounting Kit-Adds 1"  
Equipo/Herramientas para Monturas  
en Losa Gruesa-Más 1"

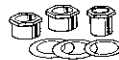

**RP10700**  
Ceramic Seats, O-Rings, Springs-For RP8230 Stem  
Asientos de Cerámica, Anillos "O",  
Resortes-para Espiga RP8230



**RP10797** - See/Ver RP70

**RP10798**  
Tubes-Bidet  
Tubos-Bidé



**RP10799**  
Diverter Assy.-3H T/S (casting) -  
See RP21598 if Seal Keeps Tearing  
Ensamble del Desviador-3H T/S  
(fund.)-Ver RP21598 si el sello  
se rasga

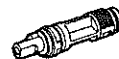

**RP10800** - See/Ver RP18304 or/o RP18312

**RP10801** - See/Ver RP18304 or/o RP18312

**RP10802, RP10802PB, RP10802SB** (for antique brass/para bronce antiguo)  
Sleeve-(For Use w/Square or Elliptical Escutcheons-  
2/3H T/S)  
Manguito-(para uso con chapetones  
cuadrados y elípticos-2/3H T/S)

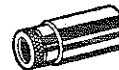

**RP10803**  
Overflow Ell-17ga. for RP691/RP693/RP695  
Desbordo Acodado-17 ga. para  
RP691/RP693/RP695



**RP10965, RP10965AB, RP10965AL, RP10965PB, RP10965SB\*, RP10965WH**  
Base w/Gasket-W/S End Valve-2" Diameter  
Base con Empaque-Válvula Final W/S-  
2" Dia.



**RP10994**  
Spacer-For RP6463 Pop-Up Drain Assy.  
Separador-para RP6463 Ensamble del  
Desagüe Automático Drenaje



**RP11016**  
Thick Tile Mounting Kit-Bulk Pack of RP11052  
Equipo/Herramientas para Monturas en Losa  
Gruesa-Equipo de Cantidades Grandes de RP11052

**RP11017**  
Thick Tile Mounting Kit-Bulk Pack of RP11053  
Equipo/Herramientas para Monturas en Losa  
Gruesa-Equipo de Cantidades Grandes de RP11053

**RP11052**  
Thick Tile Mounting Kit-Adds 1"  
Equipo/Herramientas para Monturas  
en Losa Gruesa-Más 1"

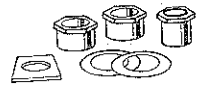

**RP11053**  
Thick Tile Mounting Kit-Adds 1"  
Equipo/Herramientas para Monturas  
en Losa Gruesa-Más 1"

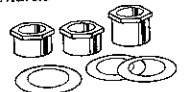

**RP11077**  
Mounting Ell & Nuts-Bulk Pack of RP5844  
Acodado de Montura y Tuercas-  
Equipo de Cantidades Grandes de RP5844

**RP11078**  
Valve Spacer w/Ells & Nuts-Bulk Pack of RP5845  
Separador de la Válvula con Acodados y Tuercas-  
Equipo de Cantidades Grandes de RP5845

**RP11079**  
Fiberglass Mounting Bracket-Bulk Pack of RP3888  
Soporte para Montar de Vidrio Fibroso

**RP11096**  
Thick Tile Mounting Kit-Bulk Pack of RP10612  
Equipo/Herramientas para Monturas en Losa Gruesa-  
Equipo de Cantidades Grandes de RP10612

**RP11097**  
Thick Tile Mounting Kit-Bulk Pack of RP5846  
Equipo/Herramientas para Monturas en Losa Gruesa-  
Equipo de Cantidades Grandes de RP5846

**RP11099**  
Thick Tile Mounting Kit-Bulk Pack of RP18504  
Equipo/Herramientas para Monturas en Losa Gruesa-  
Equipo de Cantidades Grandes de RP18504

**RP11710, RP11710PB, RP11710WH**  
C-Shape Shower Arm  
Brazo de Regadera en forma "C"



**RP11712\***  
Gasket/Empaque - 460



**RP11713\***  
Spout Hub-460  
Cubo del Tubo de Salida-460



**RP11715\***  
Hose Adapter Assy.-460  
Ensamble de Adaptador de Manguera-460



**RP11716\***  
Cover, Support & Lever-460  
Cubierta, Soporte y Palanca-460



**RP11717\***  
Hose Assy.-460  
Ensamble de Manguera-460



**RP11718** - See/Ver RP21543

**RP11719AL\*, RP11719GR\*, RP11719WH\***  
Spout Assy.-460  
Ensamble del Tubo de Salida-460

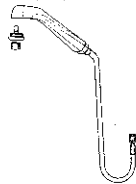

**RP11721**  
Mounting Bracket-462/466  
Abrazadera de Montura-462/466



**RP11722**  
Nut & Wrench/Tuerca y Llave  
(130, 430, 172, 173, 174, 460, 461, 462, 466)



**RP11723**  
Zinc Weights & Screws-462/466  
Pesas de Zinc y Tornillos-462/466



**RP11725GR\***  
Spray Face Assy.-460  
Ensamble-Cara del Rociador-460



**RP11729**  
O-Ring & Gasket  
Anillo "O" y Empaque



**RP11768\*** - See/Ver H22 & A22  
**RP11768AB\*** - See/Ver H22AB & A22AB  
**RP11768CBBRS\*** - See/Ver H22 & A22PB  
**RP11768CPBRS\*** - See/Ver H22PB & A22  
**RP11768PB\*** - See/Ver H22PB & A22PB  
**RP11768SB\***

**RP11768HDF**  
Handles w/Screws-Brass Lever-  
Red/Blue Bands-2H  
Manijas con Tornillos-Palanca  
Bronce-Franjas Roja/Azul-2H

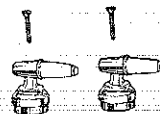

**RP118400S**  
Body Pin-Over-size-1H Body for Lever Handles  
Espiga-Muy Grande-1H Cuerpo para  
Manijas de Palanca



**RP11886** - See/Ver RP20666

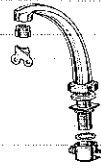

**RP11887**  
Hose-SS Braided -16"-2H W/S HDF - 1/4"-18 NPSM  
Manguera-Trenzada de Acero  
Inoxidable-16"-2H W/S HDF-  
1/4"-18 NPSM



**RP11886** - See/Ver RP12506

**RP12036**  
O-Ring/Anillo "O"



**RP12037**  
Gasket/Empaque



**RP12038**  
Spout Nut-2H W/S  
Tuerca de Salida-2H W/S



**RP12039**  
Spout Tee-2H W/S  
"T" de Salida-2H W/S



**RP12086**  
Flow Limiter for Showerhead-2.5 gpm @ 80 psi  
(RP6122/RP6212)  
Limitador de Flujo para Cabeza de  
Regadera-9.5L/Min @ 551 kPa  
(RP6122/RP6212)



**RP12301**  
Vacuum Breaker Ball Assy.-SS-Single Lever -  
Pull-Out Spray Models  
Ensamble de la Bola para Romper el Vacío



**RP12302**  
Check Valve Assy. - Pull-Out Spray Models  
Ensamble de la Válvula de Control



**RP12303\***  
Hook-Up Kit (For 1/2" IPS Male Adapters)  
Equipo para Conexión (para Adaptadores de  
1/2" IPS Macho)



**RP12307**  
Tub Spout Brass Adapter w/O-Ring (For  
RP5834/RP7533/RP17453/RP17454 Tub Spouts)  
Adaptador de Tubo de Salida del Agua para Bañera  
Bronce con Anillo "O" (para  
RP5834/RP7533/RP17453/RP17454  
Tubos del Salida del Agua para Bañera)



**RP12487, RP12487PB,**  
**RP12487SB** (for antique brass/para bronce antiguo)  
Diverter Assy. - Pull-Up Div. Tub Spout (For  
RP5834/RP7533/RP19820 Tub Spouts)  
Ensamble de Desviador-Tubo de Salida del Agua  
para Bañera/Botón Desviador  
de Alzar (Para  
RP5834/RP7533/RP19820  
Tubos de Salida del Agua  
para Bañeras)



**RP12490**  
Screws-Red/Blue-VR-Lever Handle -  
10-24x5/8"  
Tornillos-Rojo/Azul-Resistente al Maltrato-Palanca -  
10-24x5/8"



**RP12491**  
Handles w/Screw-Wrist Blade-Red/Blue Screws  
Manijas con Tornillos-Tipo de Aleta-Tornillos de  
Rojo/Azul



**RP12492**  
Screws-Lever Handle - 10-24x1/4" - VR  
Tornillos-Palanca - 10-24x1/4"-Resistente al  
Maltrato

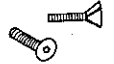

**RP12494\*** - See/Ver RP12505

**RP12495**  
End Valve Assy. - Stem Unit w/Brass Stem-  
SS Plate - 2H HDF<sup>®</sup>  
Ensamble de la Válvula Final-Unidad del  
Vástago con Vástago de Bronce-Placa de  
Acero Inoxidable-2H HDF<sup>®</sup>



**RP12496**  
End Valve Assy.-WF - Stem Unit w/Brass Stem-  
SS Plate - 2H HDF<sup>®</sup>  
Ensamble de la Válvula Final-WF-  
Unidad del Vástago con Vástago de  
Bronce-Placa de Acero Inoxidable-  
2H HDF<sup>®</sup>



**RP12497** - See/Ver RP20665

**RP12498\***  
Pop-Up Drain Assy.-Metal-5541/5545  
Ensamble de Desagüe Automático-  
Metálico-5541/5545



**RP12499** - See/Ver RP20668

**RP12500\*** - See/Ver RP20667

**RP12501\***  
Knob & Rod Assy.-5541/5545  
Ensamble de Barra de  
Alzar-5541/5545

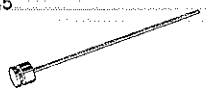

# Miscellaneous Parts/Piezas Misceláneas

**RP12503**  
Vacuum Breaker-Personal Shower-For Exposed Applications Only  
*Rompedor de Vacío-Regadera Personal-para Sólo para Aplicaciones-Expuestas*



**RP12504**  
Hook w/Screws & Anchors-Personal Shower  
*Gancho con Tornillos y Pernos Prisioneros-Regadera Personal*



**RP12505**  
Spout Assy.-Waterfall®-9 1/2" Long-2.0 gpm @ 80 psi VR Aerator  
*Ensamble del Tubo de Salida del Agua-Waterfall®-9 1/2" Largo-7.6L/Min @ 551 kPa Aireador de Resistente al Maltrato*

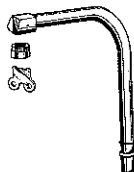

**RP12506**  
End Valve Assy.- WF - Slow Self-Close W/S  
*Ensamble de la Válvula Final-WF-W/S de Cierre Automático Lento*



**RP12507**  
Spout Assy.-711  
*Ensamble del Tubo de Salida-711*

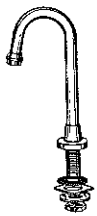

**RP12508\***  
Wrench-Plastic-VR Aerator-Old Style  
*Llave de Tuercas-Plástica-Aireador VR-Estilo Viejo*



**RP12516**  
Strap & Screw - Metal Pop-Up Drain Assy.  
*Barra Chata y Tornillos-Ensamble del Desaghe Automático-Metálico*



**RP12517**  
Horizontal Rod w/Clip - Metal Pop-Up Drain Assy.  
*Barra Horizontal con Grapa-Ensamble del Desaghe Automático-Metálico*

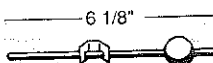

**RP12518**  
Spring Clip - Metal Pop-Up Drain Assy.  
*Grapa de Resorte-Ensamble del Desaghe Automático-Metálico*



**RP12574**  
Screws-VR-2/3H T/S-Lever  
*Tornillos-Resistente al Maltrato-2/3H T/S-Palanca*



**RP12629**  
Screws - 2/3H T/S-Knob - 10-24x3"  
*Tornillos - 2/3H T/S- Perilla - 10-24x3"*



**RP12630, RP12630AL, RP12630PB, RP12630SB** (for antique brass/para bronce antiguo), **RP12630WH**  
Screws-2/3H T/S-Lever - 10-24x3 3/4"  
*Tornillos-2/3H T/S-Palanca - 10-24x3 3/4"*



**RP12631\*** - See RP18627 Extender Plus Appropriate Screw (RP12629, RP12630, RP20184 or RP12574)  
*Ver RP18627 Extensión Más Tornillo Apropiado (RP12629, RP12630, RP20184 o RP12574)*



**RP12632\*, RP12632PB\*, RP12632SB\*** (for antique brass/para bronce antiguo)- See RP18627 Extender Plus Appropriate Screw (RP12629, RP12630, RP20184 or RP12574)  
*Ver RP18627 Extensión Más Tornillo Apropiado (RP12629, RP12630, RP20184 o RP12574)*

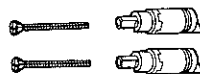

**RP12633\*** - See RP18627 Extender Plus Appropriate Screw (RP12629, RP12630, RP20184 or RP12574)  
*Ver RP18627 Extensión Más Tornillo Apropiado (RP12629, RP12630, RP20184 o RP12574)*



**RP12634**  
Hose-60"-Personal Shower  
*Manguera-60"-Regadera Personal*



**RP12635** - See/Ver RP7408

**RP12636\***  
Spout Coupling Tee-W/S  
*Acoplamiento del Tubo de Salida-W/S*



**RP12691**  
Spacer/Separador-101/175/570/575/710/711"



**RP13161, RP13161PB**  
Lever Handle Screw - 10-24x1 1/4"  
*Tornillo de Palanca - 10-24x1 1/4"*



**RP13498**  
Spanner Wrench for RPW66HDF  
*Llave de Gancho para RPW66HDF*



**RP13740, RP13740AB, RP13740AL, RP13740CB, RP13740PB, RP13740SB\*, RP13740WH**  
Vacuum Breaker Assy.-Bidet  
*Ensamble de Romper el Vacío-Bidé*



**RP13928AL\*, RP13928GR\*, RP13928RD\*, RP13928WH\***  
Handle w/Button & Set Screw-Eurostyle Kit/Lav/T-S  
*Manija con Botón y Tornillo de Ajuste-Eurostyle Cocina/Lav/T-S*



**RP13929**  
Button & Set Screw - Red/Blue Indicator-130/430  
*Botón y Tornillo de Ajuste-Indicadores Rojo/Azul-130/430*



**RP13930AL\*, RP13930GR\*, RP13930RD\*, RP13930WH\***  
Cap w/Adjusting Ring-Eurostyle  
*Tapa con Anillo Ajustable-Eurostyle*



**RP13931AL\*, RP13931GR\*, RP13931RD\*, RP13931WH\***  
Cap-Eurostyle  
*Tapa-Eurostyle*



**RP13932\***  
Spring Washer-Eurostyle  
*Arandela de Resorte-Eurostyle*



**RP13933AL\*, RP13933GR\*, RP13933RD\*, RP13933WH\***  
Spout Assy. w/Aerator-Eurostyle  
*Ensamble del Tubo de Salida con Aireador-Eurostyle*



**RP13934AL\*, RP13934GR\*, RP13934RD\*, RP13934WH\***  
Collar-Eurostyle  
*Collar-Eurostyle*



**RP13935\***  
Retaining Seal-130/430/Eurostyle  
*Sello de Retención-130/430/Eurostyle*



\* Check for inventory on discontinued parts. Vea el Inventario para Obtener Piezas Descontinuadas

RP13936\*, RP13936AL\*, RP13936GR\*,  
RP13936MB\*, RP13936PB\*, RP13936RD\*,  
RP13936WH\*  
Escutcheon/Chapetón - 130/430/Eurostyle



RP13937\*  
Gasket/Empaque - 130/430/Eurostyle



RP13938  
O-Ring/Anillo "O" - 4530



RP13939\*  
Supply Tubes/Tubos - Eurostyle



RP13940\*  
Mounting Washer & Wrench (21100, 21400, 21529,  
21709, 25100, 25400 & 25520)  
Arandela y Llave de Montura (21100,  
21400, 21529, 21709, 25100, 25400 y  
25520)



RP13941\*  
Adjusting Wrench-130/430/Eurostyle  
Llave de Ajuste-130/430/Eurostyle



RP13943\*, RP13943AL\*, RP13943GR\*,  
RP13943PB\*, RP13943RD\*, RP13943WH\*  
Escutcheon/Chapetón - Eurostyle-Lav



RP13944\*  
Gasket/Empaque - Eurostyle



RP13945AL\*, RP13945GR\*,  
RP13945RD\*, RP13945WH\*  
Pop-Up Drain Assy.-Metal -Eurostyle  
Ensamble de Desagüe Automático-  
Metálico-Eurostyle

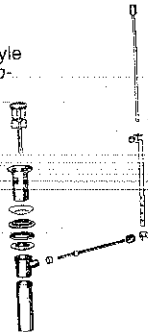

RP13946AL\*, RP13946GR\*,  
RP13946RD\*, RP13946WH\*  
Spray Outlet-Eurostyle-Bidé  
Boca de Salida del Rociador-Eurostyle-Bidé



RP13947\*  
Retaining Seal-Eurostyle  
Sello de Retención-Eurostyle



RP13949AL\*, RP13949GR\*, RP13949RD\*,  
RP13949WH\*  
Sleeve/Manguito - Eurostyle-T/S



RP13950\*  
Screws/Tornillos - Eurostyle-T/S



RP13951AL\*, RP13951GR\*, RP13951RD\*,  
RP13951WH\*  
Escutcheon/Chapetón - Eurostyle-T/S



RP13952AL\*, RP13952RD\*, RP13952WH\*  
Showerhead-Eurostyle-T/S  
Cabeza de Regadera-Eurostyle-T/S



RP13955\*  
Adapter-Tub Spout-Eurostyle  
Adaptador-Tubo de Salida para Bañera-Eurostyle



RP13956AL\*, RP13956GR\*, RP13956RD\*,  
RP13956WH\*  
Lift Rod-Eurostyle Drain Assy.  
Barra de Alzar-Ensamble de  
Drenaje Eurostyle



RP13957\*, RP13957AL\*, RP13957GR\*, RP13957PB\*,  
RP13957RD\*, RP13957WH\*  
Stopper-Eurostyle Drain Assy.  
Tapón-Ensamble de Drenaje Eurostyle



RP13958\*, RP13958AL\*, RP13958GR\*,  
RP13958PB\*, RP13958WH\*  
Flange-Eurostyle Drain Assy.  
Brida-Ensamble de Drenaje Eurostyle



RP13959\*  
Gasket-White-Eurostyle Drain Assy.  
Empaque-Blanco-Ensamble de Drenaje Eurostyle



RP13960\*  
Gasket-Black-Eurostyle Drain Assy.  
Empaque-Negro-Ensamble de Drenaje Eurostyle



RP13962\*  
Nut-Eurostyle Drain Assy.  
Tuerca-Ensamble de Drenaje Eurostyle



RP13963\*  
Body-Eurostyle Drain Assy.  
Cuerpo-Ensamble de Drenaje Eurostyle



RP13964\*  
Tailpiece-Eurostyle Drain Assy.  
Tubo de Cola-Ensamble de Drenaje Eurostyle



RP13965\*  
Pivot Seat-Eurostyle Drain Assy.  
Asiento Pivote-Ensamble de Drenaje Eurostyle



RP13966\*  
Pivot Rod w/Spring Clip-Eurostyle Drain Assy.  
Barra Pivote con Grapa de Resorte-Ensamble de  
Drenaje Eurostyle



RP13967\*  
Nut-Eurostyle Drain Assy.  
Tuerca-Ensamble de Drenaje Eurostyle



RP14120  
Repair Kit - Slow Self-Close Faucets - Bulk (100 cup  
seals, 100 seats, 100 internal O-Rings, 25-RP6375  
Set Screws & 1-RP6420 Wrench)  
Herramientas para Reparaciones-Llaves de Cierre  
Automático-Cantidades Grandes (100 sellos de taza,  
100 asientos, 100 anillos "O" internos, 25 tornillos de  
ajuste RP6375, y 1 llave de tuercas RP6420)

# Miscellaneous Parts/Piezas Misceláneas

**RP14129**  
Washer & Screen-Gourmet™  
Arandela y Rejilla-Gourmet™



**RP14169\*, RP14169AL\*,  
RP14169MB\*, RP14169WH\***  
Handle w/Button & Set Screw-21100/21400  
Manija con Botón y Tornillo  
de Ajuste -21100/21400



**RP14170\***  
Button & Set Screw-Red/Blue-21100/21400  
Botón y Tornillo de Ajuste-Rojo/Azul-21100/21400

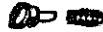

**RP14171\*, RP14171AL\*, RP14171GR\*,  
RP14171RD\*, RP14171WH\***  
Cap/Tapón - 21100/21400



**RP14172\*, RP14172AL\*, RP14172GR\*,  
RP14172MB\*, RP14172WH\***  
Spout Assy. w/Aerator-21100/21400  
Ensamble del Tubo de Salida con Aireador -  
21100/21400



**RP14173\***  
Diverter w/Screw-in Cap - 21100/21400  
Desviador con Tapón-21100/21400



**RP14174\*, RP14174AL\*, RP14174RD\*, RP14174WH\***  
Base/Base - 21100/21400



**RP14177\***  
Snap Ring-21100/21400  
Aro de Resorte-21100/21400



**RP14178\***  
Swivel Stops-21100/21400  
Topes Giratorios-21100/21400



**RP14179\***  
Spout Gaskets-21100/21400 (or see RP19662)  
Empaques del Tubo de Salida-21100/21400  
(o ver RP19662)



**RP14180\***  
Cap w/Adjusting Ring-21100/21400  
Tapón de Anillo de Ajuste-21100/21400



**RP14273, RP14273AB, RP14273PB**  
Hot End Valve Assy.-Bidet  
Ensamble de la Válvula Final Caliente-Bidé



**RP14274, RP14274AB, R14274PB**  
Cold End Valve Assy.-Bidet  
Ensamble de la Válvula Final Fría-Bidé



**RP14281** - See/Ver RP20669

**RP14282** - See/Ver RP20666

**RP14414**  
O-Rings/Anillos "O" - 1300/1400



**RP14787\*, RP14787CB\*, RP14787CW\*,  
RP14787OAK\*, RP14787PB\*, RP14787PBOAK\*,  
RP14787PW\*, RP14787WB\*, RP14787WC\*,  
RP14787WP\***  
Handle-Lever-1600  
Manija-Palanca-1600

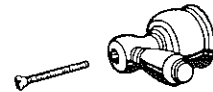

**RP14788** - See/Ver H25  
**RP14788AC** - See/Ver H25AC  
**RP14788AP** - See/Ver H25AP  
**RP14788CA** - See/Ver H25CA  
**RP14788CB** - See/Ver H25CB  
**RP14788CW** - See/Ver H25CW  
**RP14788OAK** - See/Ver H25CK  
**RP14788PA** - See/Ver H25PA  
**RP14788PB** - See/Ver H25PB  
**RP14788PBOAK** - See/Ver H25PK  
**RP14788PW** - See/Ver H25PW  
**RP14788WC** - See/Ver H25WC  
**RP14788WP** - See/Ver H25WP

**RP14789** - See/Ver H65  
**RP14789AC** - See/Ver H65AC  
**RP14789AP** - See/Ver H65AP  
**RP14789CB** - See/Ver H65CB  
**RP14789CW** - See/Ver H65CW  
**RP14789OAK** - See/Ver H65CK  
**RP14789PB** - See/Ver H65PB  
**RP14789PBOAK** - See/Ver H65PK  
**RP14789PW** - See/Ver H65PW  
**RP14789WB** - See/Ver H65PW  
**RP14789WC** - See/Ver H65WC  
**RP14789WP** - See/Ver H65WP

**RP14790** - See/Ver H26  
**RP14790AC** - See/Ver H26AC  
**RP14790AP** - See/Ver H26AP  
**RP14790CB** - See/Ver H26CB  
**RP14790PB** - See/Ver H26PB  
**RP14790WC** - See/Ver H26WC  
**RP14790WP** - See/Ver H26WP

**RP14944** - See/Ver H66  
**RP14944AC** - See/Ver H66AC  
**RP14944AP** - See/Ver H66AP  
**RP14944CB** - See/Ver H66CB  
**RP14944PB** - See/Ver H66PB  
**RP14944WC** - See/Ver H66WC  
**RP14944WP** - See/Ver H66WP

**RP14979, RP14979AB, RP14979ABLHP,  
RP14979ABRHP** - See/Ver RP14979ABLHP,  
**RP14979ABSHP** - See/Ver RP14979ABLHP,  
**RP14979ALLHP, RP14979CBBRS, RP14979CBLHP,  
RP14979CBRH, RP14979LHP, RP14979PB,  
RP14979PBLHP,  
RP14979PBRHP** - See/Ver RP14979PBLHP,  
**RP14979PBSHP** - See/Ver RP14979PBLHP,  
**RP14979RHP** - See/Ver RP14979LHP,  
**RP14979SHP** - See/Ver RP14979LHP,  
**RP14979WH, RP14979WHLHP,  
RP14979WHRHP** - See/Ver RP14979WHLHP  
Roman Tub Hand Held Shower-2.5 gpm @ 80 psi  
Regadera de Mano para  
Bañera Romana-  
9.5L/Min @ 551-kPa

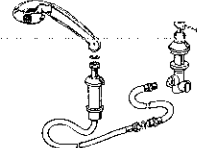

**RP14987** - See/Ver RP16669

**RP14988\*** - See/Ver RP18632

**RP14989**  
Hose-23"-Metal Mesh Braided-High Pressure-  
RT Hand Shower  
Manguera-23"-Malla Metálica  
Trenzada-Presión Alta-RT  
Regadera de Mano



**RP14990, RP14990AB, RP14990PB, RP14990SB\***  
Hose-69"-Metal Braided-RT Hand Shower  
Manguera-69"-Metálica Trenzada-  
RT Regadera de Mano

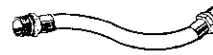

**RP14991, RP14991AB, RP14991AL, RP14991PB,  
RP14991SB\*, RP14991WH**  
Hand Piece-RT Hand Shower-  
2.5 gpm @ 80 psi  
Pieza de Mano-RT Regadera de  
Mano-9.5L/Min @ 551 kPa



**RP15069** - See/Ver A22CL

**RP15070OAK** - See/Ver A22OK  
**RP15070POR** - See/Ver A22PR  
**RP15070ROS** - See/Ver A22RS

**RP15071** - See/Ver A22  
**RP15071AB** - See/Ver A22AB  
**RP15071AL** - See/Ver A22AL  
**RP15071PB** - See/Ver A22PB  
**RP15071SB\***  
**RP15071WH** - See/Ver A22WH

**RP15081** - See/Ver H46  
**RP15081AC** - See/Ver H46AC  
**RP15081AP** - See/Ver H46AP  
**RP15081CB** - See/Ver H46CB  
**RP15081PB** - See/Ver H46PB  
**RP15081WC** - See/Ver H46WC  
**RP15081WP** - See/Ver H46WP

**RP15082AL** - See/Ver RP5653AL  
**RP15082GR** - See/Ver RP5653GR  
**RP15082RD** - See/Ver RP5653RD  
**RP15082WH** - See/Ver RP5653WH

**RP15127**  
Red/Blue Handle Decal-1500  
Manija Decal Roja/Azul-1500



\*Check for inventory on discontinued parts. *Vea el inventario para botener piezas descontinuadas.*

**RP15136**  
Plasterguard/Thin Wall Mounting Bracket-  
1300/1400/1500  
*Protector de Enlucido/Pared Delgada  
Soporte de Montura-1300/1400/1500*



**RP15183\*** - See/Ver RP26533 & RP16300

**RP15249** - See/Ver H22  
**RP15249AB** - See/Ver H22AB  
**RP15249AL** - See/Ver H22AL  
**RP15249PB** - See/Ver H22PB  
**RP15249SB\***  
**RP15249WH** - See/Ver H22WH

**RP15426** - See/Ver A62CL  
**RP15426ABBRS** - See/Ver A62AB  
**RP15426AL** - See/Ver A62AL  
**RP15426BRS** - See/Ver A62  
**RP15426OAK** - See/Ver A62OK  
**RP15426PBBRS** - See/Ver A62PB  
**RP15426POR** - See/Ver A62PR  
**RP15426ROS** - See/Ver A62RS  
**RP15426SBBRS\***  
**RP15426WH** - See/Ver A62WH

**RP15427**  
Temperature Indicator Strip-Red/Blue  
(not currently used on any product)  
*Tira Indicadora de  
Temperatura-Roja/Azul*



**RP15442, RP15442AL, RP15442PB, RP15442WH**  
Base w/Gasket-172/173/174  
(Manufactured Before 5/96)  
*Base con Empaque-172/173/174  
(Fabricado Antes 5/96)*



**RP15532** - See/Ver RP21962

**RP15533** - See/Ver RP21962

**RP15534\***  
Spout Retaining Ring - High-Rise  
(If for 2167/2467/2474, order new spout)  
*Anillo de Retención para el Tubo de Salida-Alto  
(para 2167/2467/2474, encargan tubo de  
salida nuevo)*



**RP15535, RP15535AL, RP15535PB, RP15535WH**  
Spout Bonnet - 2147/2167/2467/2447  
*Bonete del Tubo de Salida-  
2147/2167/2467/2447*



**RP15536, RP15536AL, RP15536PB, RP15536WH**  
Escutcheon/Chapetón - 2167/2467

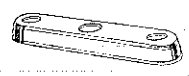

**RP15537** - See/Ver RP21461

**RP15538** - See/Ver RP21969

**RP15539, RP15539AL, RP15539PB, RP15539WH**  
Bonnet/Bonete - 2567



**RP15540** - See/Ver RP22661

**RP15541, RP15541AL, RP15541PB, RP15541WH**  
Escutcheon/Chapetón - 2567



**RP15542\***  
Washers/Arandelas - 2170/2171/2172/2567



**RP15543\***  
Gasket/Empaque - 2170/2171/2172/2567



**RP15544\*** - See/Ver RP26533 & RP15545

**RP15545, RP15545PB**  
Knob & Rod Assy.-2567  
*Ensamble del Barra de Alzar-2567*



**RP15546, RP15546AC, RP15546AP,  
RP15546CB, RP15546PB,  
RP15546WC, RP15546WP**  
Spout Assy.-3567  
*Ensamble del Tubo de Salida-3567*

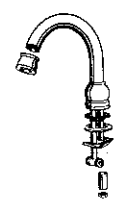

**RP15547\***  
Spout Washer & O-Ring - Old Style 3567  
*Roldana de Salida y Anillo "O"-  
Estilo Viejo 3567*

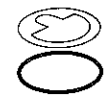

**RP15549** - See/Ver RP4258

**RP15550** - See/Ver RP26533 & RP15551

**RP15551, RP15551PB**  
Knob & Rod Assy.-3567  
*Ensamble del Barra de Alzar-3567*



**RP15552** - See/Ver RP16615

**RP15553** - See/Ver RP6152

**RP15554, RP15554PB**  
Escutcheon/Chapetón - NEO STYLE™.  
2H T/S



**RP15555** - See/Ver RP10965

**RP15565**  
Ejector-2H T/S-Fabricated Brass Body  
*Expulsor-2H T/S-Sólo Cuerpo Bronce*



**RP15800AL\*, RP15800GR\*,  
RP15800WH\***  
Handle w/Set Screw-460/461  
*Manija con Tornillo de Ajuste-460/461*



**RP16125** - See/Ver A72CL  
**RP16125ABBRS** - See/Ver A72AB  
**RP16125ALBRS** - See/Ver A72AL  
**RP16125BRS** - See/Ver A72  
**RP16125OAK** - See/Ver A72OK  
**RP16125PBBRS** - See/Ver A72PB  
**RP16125POR** - See/Ver A72PR  
**RP16125ROS** - See/Ver A72RS  
**RP16125SBBRS\***  
**RP16125WHBRS** - See/Ver A72WH

Order A12  
accents for 1500  
series mfrd.  
before 6/96

**RP16135\***  
Base/Base - 461



**RP16201**  
Button-Red/Blue Indicators-1500  
*Botón-Indicadores Rojo/Azul-1500*



**RP16202 (gray/gris)**  
**RP16202AL, RP16202WH**  
Temperature Handle-1500  
*Manija de Temperatura-1500*



**RP16203**  
Rotational Limit Stop-1500  
*Tope para Limitar-1500*



**RP16204, RP16204AB, RP16204BRS, RP16204PB**  
Handle Assy.-Vol. Control Lever Handle-1500  
*Ensamble de Manija-Manija de Control de Volumen  
Palanca-1500*



**RP16205\*** - See/Ver RP22737 for/para 1300/1400;  
RP22738 for/para 1500

**RP16206\*** - See/Ver RP22737 for/para 1300/1400;  
RP22738 for/para 1500

**RP16207**  
Cartridge Assy.-SS Plate-1500  
*Ensamble del Casquete-  
Placa de Acero Inoxidable-1500*

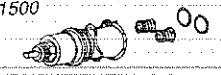

**RP16208**  
Seats, Springs & Quad Rings-1500  
*Asientos, Resortes y Anillos Cuatro-1500*

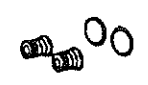

# Miscellaneous Parts/Piezas Misceláneas

RP16209\*, RP16209AB\*,  
RP16209PB\*, RP16209WH\*  
Escutcheon-1500  
(Esc. Screw Holes at Bottom)  
Chapetón-1500  
(Huecos para Tornillos Están en la  
Parte de Abajo del Chapetón)



RP16210\*, RP16210AB\*,  
RP16210PB\*, RP16210WH\*  
Escutcheon-For Push Button Diverter-1500  
(Esc. Screw Holes at Bottom)  
Chapetón-para Desviador de Botón  
Pulsador-1500 (Huecos para Tornillos  
Están en la Parte de Abajo  
del Chapetón)



RP16211  
SS Plate & O-Rings - 1500  
Placa de Acero Inoxidable y Anillos "O"-1500



RP16212  
Handle Nut-1500  
Tuerca y Manija-1500



RP16213  
Screwdriver Stop Assy.-  
1300/1400/1500/RP6005/RP5876  
Ensamble del Tope Destornillador-  
1300/1400/1500/RP6005/RP5876



RP16300, RP16300PB,  
RP16300SB (for antique brass/para bronce  
antiguo),  
RP16300WH  
Lift Rod - LHP - Pop-Up Drain Assy.  
Barra de Alzar-LHP-Ensamble de  
Desagüe Automático



RP16309\*  
Fill Valve for Delta Water Closet  
Válvula para Llenar el Tanque para  
inodoro de Delta

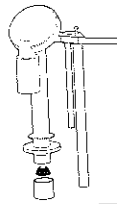

RP16317\*  
Spout Base Plates & Tape-3567 (Before 2/91)  
Placa de Base de Salida y Cinta Engomada-3567  
(Antes 2/91)



RP16318\*  
Spout Nut & Spacer-3567 (Before 2/91)  
Tuerca del Tubo de Salida y Separador-3567  
(Antes 2/91)



RP16319\*  
Bracket-3567 (Before 2/91)  
Soporte-3567 (Antes 2/91)



RP16396  
Handle Set Screw - 130/430/466/21100/21400  
Tornillo de Ajuste de Manija-  
130/430/466/21100/21400



RP16397, RP16397AL, RP16397WH  
Loop Handle w/Set Screw-130/430/466  
Manija con Argolla con Tornillo de Ajuste-  
130/430/466



RP16398\*  
Washer/Arandela - 130/430



RP16399, RP16399AL, RP16399PB, RP16399WH  
Cap w/Adjusting Ring-130/430/462/466  
Tapón con Anillo de Ajuste-130/430/462/466



RP16400\*, RP16400AL\*, RP16400WH\*  
Spout Assy.-130/430  
Ensamble del Tubo de Salida-  
130/430



RP16423  
SS Reverse Ball-Single Knob Handle  
Bola de Inversión-Acero Inoxidable-  
Manija de Perilla Sinclilla



RP16471\*  
Support Ring-130/430/21460/Eurostyle  
Anillo de Soporte-130/430/21460/Eurostyle



RP16492\*, RP16492PB\*, RP16492WC\*, RP16492WP\*  
Spout w/O-Ring - 2767  
Tubo de Salida con Anillo "O"-2767

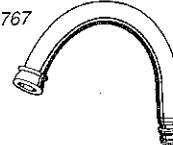

RP16493  
Spout O-Ring - 2767  
Anillo "O" para del Tubo de Salida-2767



RP16494\*, RP16494PB\*, RP16494WH\*  
Spout Bonnet-2767  
Bonete para el Tubo de Salida-2767



RP16495\*  
Gasket/Empaque - 2767



RP16496\*  
Nut & Washer-2767  
Tuerca y Arandela-2767



RP16497\*  
Set Screw/Tornillo de Ajuste - 10-32x1/4" - 2767

RP16498\*  
Spout Body-2767  
Cuerpo para Tubo de Salida-2767

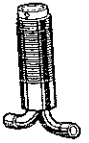

RP16499\*, RP16499AB\*, RP16499PB\*,  
RP16499SB\*, RP16499WH\*  
End Valve Assy.-2767  
Ensamble de la Válvula Final-2767



RP16500\*, RP16500CB\*, RP16500PB\*,  
RP16500WC\*, RP16500WP\*  
Spout Assy.-2767  
Ensamble del Tubo de Salida -2767

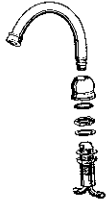

RP16595, RP16595AB, RP16595PB,  
RP16595SB\*, RP16595WH  
Deep Escutcheon for Push Button Diverter-  
1" Deeper-600/1600  
Chapetón de Hondo para Desviador  
de Botón Pulsador-1" Más Hondo-  
600/1600



RP16609\*, RP16609PB\*,  
RP16609SB\* (for antique brass/para bronce antiguo)  
Spout Button & Screw (Plug in Front)-2710  
Botón del Tubo de Salida y Tornillo  
(el tapón en el frente)-2710



RP16610\*, RP16610AB\*, RP16610PB\*, RP16610SB\*  
Slip-On Spout (Plug in Front) - 2710  
Salida de Deslice (el tapón en el frente)-2710

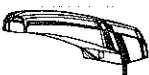

RP16611\*  
Base & O-Ring (Plug in Front) - Slip-On 2710  
Base y Anillo "O" (el tapón en el frente)-Deslice 2710



RP16612\*  
Nuts & Washers (Plug in Front) - Slip-On 2710  
Tuercas y Arandelas (el tapón en el  
frente)-Deslice 2710



RP16613\*  
O-Ring (Plug in Front) - Slip-On 2710  
Anillo "O" (el tapón en el frente)-Deslice 2710



**RP16614\***  
Spout Adapter Assy. (Plug in Front) - Slip-On 2710  
Ensamble del Tubo de Salida  
Adaptador (el tapón en el frente) -  
Deslice 2710



**RP16615\***, **RP16615AL\***, **RP16615PB\***,  
**RP16615SB\*** (for antique brass/para bronce antiguo),  
**RP16615WH\***  
Screws-Lever Handle-RT - 10-29x1 5/8"  
Tornillos-Palanca-RT - 10-29x1 5/8"



**RP16616** - See/Ver H62  
**RP16616AB** - See/Ver H62AB  
**RP16616AL** - See/Ver H62AL  
**RP16616PB** - See/Ver H62PB  
**RP16616SB\***  
**RP16616WH** - See/Ver H62WH

**RP16617CBBRS** - See/Ver H62 & A62PB  
**RP16617CPBRS** - See/Ver H62PB & A62

**RP16634\***  
Adapter - 3/8"x1/2" - 2710  
Adaptador - 3/8"x1/2" - 2710



**RP16668**, **RP16668AB**, **RP16668PB**,  
**RP16668SB\***, **RP16668WH**  
Elbow Assy.-RT Hand Shower  
Ensamble de Conexión-  
RT Regadera de Mano



**RP16669**, **RP16669AB**, **RP16669AL**,  
**RP16669PB**, **RP16669SB\***, **RP16669WH**  
Escutcheon/Spray Support-RT Hand Shower  
Chapetón/Soporte del Rociador-RT  
Regadera de Mano

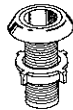

**RP16670\***, **RP16670AB\***, **RP16670PB\***, **RP16670SB\***  
Handle-RT Hand Shower  
Manija-RT Regadera de Mano



**RP16671\***, **RP16671AB\***, **RP16671PB\***, **RP16671SB\***  
Escutcheon-RT Hand Shower  
Chapetón-RT Regadera de Mano



**RP16672\***, **RP16672AB\***, **RP16672PB\***, **RP16672SB\***  
Handle Screw-RT Hand Shower  
Tornillo de Manija-RT Regadera de Mano



**RP16684**  
Drain Ell-17 Gauge-Bath Waste Drain Assy.  
Tubo Acodado-Calibre 17-  
Ensamble del Drenaje-Bañera

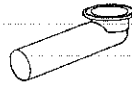

**RP16685**  
Drain Ell-20 Gauge-Bath Waste Drain Assy.  
Tubo Acodado-Calibre 20-  
Ensamble del Drenaje-Bañera

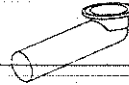

**RP16686**, **RP16686AB**, **RP16686PB**, **RP16686SB\***  
Stopper Assy.-Bath Waste Drain Assy.  
Ensamble del Tapón-Ensamble del  
Drenaje-Bañera



**RP16687**, **RP16687AB**, **RP16687PB**, **RP16687SB\***  
Waste Plug-Bath Waste Drain Assy. -  
1 1/2"x11 1/2" NDSM  
Tapón del Desagüe-Ensamble de Drenaje para  
Desagüe de la Bañera



**RP16687**  
End Valve Adjusting Wrench-RT  
Llave de Tuercas Ajustadora para la  
Válvula Final-RT



**RP16915**  
Spacer/Separador - 560



**RP16919**  
Handle w/Button & Screw-Clear Knob-562  
Manija con Botón y Tornillo-  
Perilla de Transparente-562



**RP16920**  
Button-Clear-1 3/8 Dia.-562  
Botón-Transparente-1 3/8 Dia.-562



**RP16921**  
Base w/Gasket-2 3/8" Dia. 1/8" High Collar-560  
Base con Empaque-2 3/8" Dia. 1/8" Collar-560



**RP17110**  
Spindle-LHP Handle  
Husillo-Manija LHP



**RP17111**, **RP17111PB**,  
**RP17111SB** (for antique brass/para bronce antiguo)  
Nut-Small-LHP Handle Tuercas-Pequeña-  
Manija de LHP



**RP17143** - See/Ver RP21965

**RP17144**  
Spout Bonnet-2474  
Bonete del Tubo de Salida-2474



**RP17160**  
Label-Red/Blue (to be used only  
on 1600 pressure balance)  
Etiqueta-Rojo/Azul (uso sólo con  
Presión Balanceada 1600)



**RP17353**, **RP17353PB**, **RP17353WH**  
C-Shape OTR Spout  
Tubo de Salida OTR en  
Forma de "C"



**RP17443**, **RP17443AB**, **RP17443AL**, **RP17443PB**,  
**RP17443SB\***, **RP17443WH**  
Lever Handle w/Set Screw-1H Lav/600  
Palanca con Tornillo de Ajuste-  
1H Lav/600



**RP17444**, **RP17444AB**, **RP17444AL**, **RP17444PB**,  
**RP17444SB\***, **RP17444WH**  
Undercover Plate w/Screw-1H Centerset Lav  
Placa con Tornillo-1H Lav de Centro



**RP17445**  
Base Plate-1H Centerset Lav  
Placa-1H Lav de Centro



**RP17446**, **RP17446PB**  
Button-Clear-Wave-1H Centerset Lav-1 1/2" Dia.  
Botón-Dibujo de Transparente-  
1H Lav de Centro-1 1/2" Dia.



**RP17448** - See/Ver RP6369

**RP17449**, **RP17449PB**  
Handle w/Button & Screw-Clear Knob-  
1H Centerset Lav  
Manija con Botón y Tornillo-Perilla de  
Transparente-1H Lav de Centro

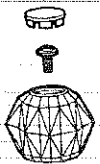

**RP17451**, **RP17451PB**  
Handle w/Button & Screw-Clear Knob-600  
Manija con Botón y Tornillo-  
Perilla de Transparente-600

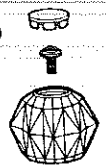



# Miscellaneous Parts/Piezas Misceláneas

**RP17453**

Tub Spout - Pull-Down Diverter - Non-Metallic -  
1/2" IPS or 1/2" CWT  
Tubo de Salida para Bañera-  
Desviador de Halar-  
No Metálico-1/2" IPS o  
1/2" CWT

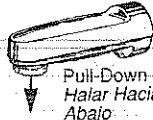

Pull-Down  
Halar Hacia  
Abajo

**RP17454, RP17454AB, RP17454AL, RP17454CB,  
RP17454PB, RP17454SB\*, RP17454WC,  
RP17454WH, RP17454WP**

Tub Spout - Pull-Down Diverter - Metal-  
1/2" IPS or 1/2" CWT  
Tubo de Salida para Bañera-  
Desviador de Halar-Metálico-  
1/2" IPS o 1/2" CWT



Pull-Down  
Halar Hacia  
Abajo

**RP17472**

Removable Decal for Pull-Down Spout Operation  
Etiqueta para la Operación de Halar el  
Tubo de Salida Hacia Abajo



**RP17498**

Escutcheon Label-Red/Blue-600/1600  
Etiqueta de Chapetón-Rojo/Azul-600/1600



**RP17655** - See/Ver H71

**RP17655PB** - See/Ver H71PB

**RP17656\*, RP17656PB\***

Button-Clear-Arrow-1 1/2" Dia.-1600  
Botón-Transparente-Flecha-1 1/2" Dia.-1600



**RP17687\*, RP17687AL\*, RP17687PB\*, RP17687WH\***

Spout-21109/21409  
Tubo de Salida-21109/21409

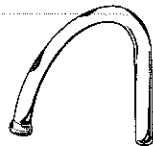

**RP17688\*, RP17688AL\*, RP17688PB\*, RP17688WH\***

Screw/Tornillo - 21109/21409/21529/21709



**RP17689\***

Spout Adapter-21109/21409/21529/21709  
Adaptador del Tubo de Salida-  
21109/21409/21529/21709



**RP17690\***

O-Ring/Anillo "O" - 21109/21409/21529/21709



**RP17691\***

Diverter/Desviador - 21409



**RP17692\*, RP17692PB\***

Trim Ring-21109/21409/21529/21709  
Anillo para la Guarnición-  
21109/21409/21529/21709



**RP17693\***

SS Ball-21109/21409/21529/21649/21709  
Bola de Acero de Inoxidable-  
21109/21409/21529/21649/21709



**RP17694\***

Cam & Packing-21109/21409/21529/21649/21709  
Leva y Empaque-21109/21409/21529/21649/21709



**RP17695\*, RP17695AL\*, RP17695PB\*, RP17695WH\***

Cap w/Adjusting Ring-21109/21409/21529/21709  
Tapón con Anillo de Ajuste-  
21109/21409/21529/21709



**RP17696\*, RP17696AC\*, RP17696PB\*,  
RP17696WC\*, RP17696WP\***

Handle Assy.-21109/21409/21529/21649/21709  
Ensamble de la Manija-  
21109/21409/21529/21649/21709



**RP17697\*, RP17697AL\*, RP17697WH\***

Base/Base - 21109/21409/21709



**RP17698\***

Base Trim & O-Ring - 21109/21409/21529/21709  
Franja de Base y Anillo "O" -  
21109/21409/21529/21709



**RP17699\***

O-Rings/Anillos "O" - 21109/21409/21529/21709



**RP17700\***

Washer, Nut & Wrench-21109/21460  
Arandela, Tuerca y Llave-21109/21460



**RP17701\*, RP17701AL\*, RP17701MB\***

Spout  
Tubo de Salida

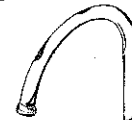

**RP17702\***

Retainer Seal-21529/21709  
Sello



**RP17703\*, RP17703PB\*, RP17703WH\***

Spout-21529  
Tubo de Salida-21529



**RP17704\*, RP17704AL\*, RP17704WH\***

Base/Base - 21529



**RP17705\*, RP17705AC\*, RP17705PB\*, RP17705WP\***

Metal Pop-Up Assy. - 21529 -  
(or See RP26533 & RP17706)  
Ensamble de Desagüe Automático  
de Metal-21529 - (o Ver RP26533 y  
RP17706)

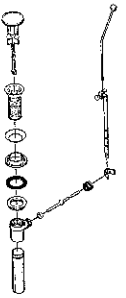

**RP17706\*, RP17706PB\***

Lift Rod-21529  
Barra de Alzar-21529



**RP17712\*, RP17712PB\*, RP17712SB\***

Spout - Large D-Shape - 3563/3564  
Tubo de Salida-Grande en Forma D-  
3563/3564



**RP17713, RP17713AL, RP17713CB,  
RP17713PB, RP17713WH**

Spout Assy.-2750  
Ensamble del Tubo de Salida-2750



**RP17730**

Diverter Assy.-3H T/S-(Fabricated Brass Body)  
Ensamble del Desviador-3H T/S-  
(Cuerpo de Fabricados de Bronce)



**RP17741, RP17741AB, RP17741PB,  
RP17741SB\*, RP17741WH**

Spout Base w/Gasket-2750  
Base del Tubo de Salida  
con Empaque-2750



**RP17781**

Spray & 4' Hose Assy.-White Head w/Chrome Band -  
1/4"-18 NPSM Female Swivel Nut -  
1/8" NPT Male Adapter -  
1/8" Female Stationary Nut  
Rociador y Ensamble de Manguera de  
4'-Cabeza Blanca con Banda de Cromo  
- 1/4"-18 NPSM Tuerca Giratoria  
Hembra - 1/8" NPT Adaptador  
Macho 1/8" Tuerca Fija Hembra



\* Check for inventory on discontinued parts. Vea el inventario para obtener piezas descontinuadas.

RP17782 - See/Ver RP17786

RP17783 - See/Ver RP17781

RP17784 - See/Ver RP17786  
RP17784AL\* - See/Ver RP17786AL

RP17785 - See/Ver RP17781

RP17786, RP17786AL  
Spray & 4' Hose Assy. - White or Almond Head -  
1/4"-18 NPSM Female Swivel Nut - 1/8" NPT Male  
Adapter - 1/8" Female Stationary Nut  
Rociador y Ensamble de Manguera  
de 4'-Cabeza Blanca o Almendra -  
1/4"-18 NPSM Tuerca Giratoria Hembra -  
1/8" NPT Adaptador Macho 1/8"  
Tuerca Fija Hembra



RP17829  
Wall Decal - Pull-Down Diverter Tub Spout Operation  
Etiqueta Adhesiva para Pared-Halar  
Hacia Abajo-Operación del Desviador  
del Tubo de Salida de Bañera



RP17909  
Spout Body Assy. - 711-HDF  
Ensamble del Cuerpo del Tubo de Salida -  
711-HDF



RP18011  
Hose-3 1/2" Long-1/4" NPSM Female Swivel Nut-550/552  
Manguera- 3 1/2" Largo-1/4" NPSM  
Tuerca Giratoria Hembra-550/552



RP18015, RP18015PB  
Spout with 3 1/2" Long Hose-  
1/4" NPSM Female Swivel Nut-550/552  
Tubo de Salida con 3 1/2" Largo  
Manguera-1/4" NPSM Tuerca  
Giratoria Hembra-550/552



RP18026  
Shank/Espiga - 550/552/750/752



RP18027, RP18027PB  
Rod Guide - 550/552  
Guía para la Barra-550/552



RP18037  
Stainless Steel Vacuum Breaker Ball Assy.-552/752  
Ensamble de la Bola para Romper el Vacío  
de Acero Inoxidable-552/752



RP18053\* - See/Ver RP50  
RP18053PB\* - See/Ver RP50PB

RP18054  
Hook-Up Kit - 550/552/750/752  
Equipo para Conexión-550/552/750/752

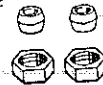

RP18090  
Screw-On Escutcheon - Non-Metallic -  
3 1/2" Dia. - 2/3H T/S  
Chapetón Atornillador - No Metálico -  
3 1/2" Dia. - 2/3H T/S



RP18129  
Test Cap - Roman Tub Rough-In  
Casquillo de Prueba-Preparación de  
Instalación para Bañera Romana



RP18136, RP18136AL, RP18136PB,  
RP18136SB (for antique brass/para bronce antiguo),  
RP18136WH  
Screw-On Sleeve - 2/3H T/S  
Manguito Atornillador - 2/3H T/S



RP18145  
Adapters & Gaskets - 550/552/750/752  
Adaptadores y Empaques -  
550/552/750/752



RP18187  
Thin Wall 2/3H T/S Mounting Spacers  
Pared Delgada 2/3H T/S Separadores de Monturas

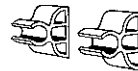

RP18218 - See/Ver A23  
RP18218AB - See/Ver A23AB  
RP18218AL - See/Ver A23AL  
RP18218PB - See/Ver A23PB  
RP18218SB\*  
RP18218WH - See/Ver A23WH

RP18219 - See/Ver A63  
RP18219AB - See/Ver A63AB  
RP18219AL - See/Ver A63AL  
RP18219PB - See/Ver A63PB  
RP18219SB\*  
RP18219WH - See/Ver A63WH

RP18220OAK - See/Ver A23OK

RP18221OAK - See/Ver A63OK

RP18222 - See/Ver A23ST  
RP18222AL - See/Ver A23STAL  
RP18222PB - See/Ver A23STPB  
RP18222SB - See/Ver A23STAB  
RP18222WH - See/Ver A23STWH

RP18223 - See/Ver A63ST

RP18227  
Conventional Rough-In Kit - Roman Tub Deck  
Equipo para Instalación de  
Válvulas en Paredes-Borde de  
Bañera Romana

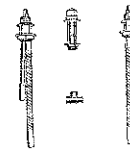

RP18235  
Thick Tile Rough-In Kit - Roman Tub Deck  
Equipo para Instalación de  
Válvulas en Paredes-  
Borde de Bañera Romana

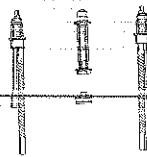

RP18276, RP18276AB, RP18276AL, RP18276PB,  
RP18276SB\*, RP18276WH  
Screw-On Escutcheon - Metal -  
3 1/2" Dia. - 2/3H T/S  
Chapetón Atornillador-No Metálico -  
3 1/2" Dia. - 2/3H T/S



RP18300, RP18300AB, RP18300AL,  
RP18300PB, RP18300SB\*, RP18300WH  
Base w/Gasket-2 1/2" Dia.-  
3/16" Collar-Roman Tub Deck  
Base con Empaque-2 1/2" Dia.-  
3/16" Collar-Borde de Bañera Romana



RP18304, RP18304AB, RP18304PB  
Screw-On Escutcheons & Sleeves - 2H T/S  
Chapetones y Manguitos Atornilladores-2H T/S



RP18312, RP18312AB, RP18312PB  
Screw-On Escutcheons & Sleeves-3H T/S  
Chapetones y Manguitos Atornilladores-3H T/S



RP18338 - See/Ver H23  
RP18338AB - See/Ver H23AB  
RP18338AL - See/Ver H23AL  
RP18338PB - See/Ver H23PB  
RP18338SB\*  
RP18338WH - See/Ver H23WH

RP18339 - See/Ver H63  
RP18339AB - See/Ver H63AB  
RP18339AL - See/Ver H63AL  
RP18339PB - See/Ver H63PB  
RP18339SB\*  
RP18339WH - See/Ver H63WH

RP18340, RP18340AB, RP18340AL, RP18340PB,  
RP18340SB\*, RP18340WH  
Handle Base & Insert-for Small Ring-  
2H Kit/Lav/T-S/Bidet  
Base de Manija y Botón-para Anillo  
Pequeño-2H Cocina/Lav/T-S/Bidé



RP18341, RP18341AB, RP18341AL,  
RP18341PB, RP18341WH  
Handle Base & Insert-for Large Ring-  
2H Roman Tub/RT Hand Shower  
Base de Manija y Botón-para Anillo  
Grande-2H RT/RT Regadera de Mano



# Miscellaneous Parts/Piezas Misceláneas

**RP18342, RP18342AB, RP18342AL, RP18342PB, RP18342SB\*, RP18342WH**  
Handle Cap-for Small Ring-2H Kit/Lav/T-S/Bidét  
Tapa de Manija-para Anillo Pequeño-2H Cor/Lav/Bañera-Reg.-Bidé



**RP18343, RP18343AB, RP18343AL, RP18343PB, RP18343WH**  
Handle Cap-for Large Ring-2H Roman Tub/  
RT Hand Shower  
Tapa de Manija-para Anillo Grande-2H RT/  
RT Regadera de Mano



**RP18344\*, RP18344PB\***  
Knob & Rod Assy.-Oak Wood  
Ensamble de Barra de Alzar-Roble



**RP18356, RP18356AB, RP18356AL, RP18356CB, RP18356PB, RP18356SB\*, RP18356WH**  
Spout Assy. - Slip-On Roman Tub Deck - Plug in Back  
Ensamble del Tubo de Salida-Montar en Bordes para  
Bañeras Romanas Deslice-  
Tapón de Botón al Fondo

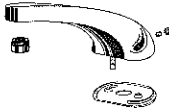

**RP18357, RP18357AL, RP18357PB, RP18357SB (for antique brass/para bronce antiguo), RP18357WH**  
Stream Straightener-Roman Tub Deck-M28x1-6g.  
Enderezador de Chorro-RT-M28x1-6g.



**RP18358, RP18358AB, RP18358AL, RP18358PB, RP18358SB\*, RP18358WH**  
Plug Button & Screw-2710/2730/2780  
Botón de Tapón y Tornillo-2710/2730/2780



**RP18359**  
Anti-Swivel Screw-2710/2711  
Tornillo Anti-Giratorio-2710/2711



**RP18360**  
Base & Clips-2710  
Base y Presillas-2710



**RP18361**  
Tee - 1/2"x1/2"x1/2"- Roman Tub Deck Rough-In  
"T"-1/2"x1/2"x1/2"-Preparación de Instalación para  
Montura de Bordes de Bañeras Romanas



**RP18362**  
O-Ring - Roman Tub Deck Rough-In  
Anillo "O"-Preparación de Instalación para Montura de  
Bordes de Bañeras Romanas



**RP18363**  
Nut & Washers - Roman Tub Deck Conv. Rough-In  
Tuercas y Arandelas-Preparación de Instalación  
Convencional para Montura de Bordes de  
Bañeras Romanas



**RP18364**  
Spout Adapter Assy. - Roman Tub Deck  
Conv. Rough-In  
Ensamble de Adaptador del Tubo de  
Salida-Preparación de Instalación  
Convencional para Montura de  
Bordes de Bañeras Romanas



**RP18365**  
Flange Nut, Nut & Washers - Roman Tub Deck  
Thick Tile Rough-In  
Tuerca de Brida, Tuerca y Arandelas-  
Preparación de Instalación para Montura de  
Borde de Bañera Romana



**RP18366**  
Upper Body Shank - Roman Tub Deck  
Thick Tile Rough-In  
Ensamble de la Espiga del Cuerpo Superior-  
Preparación de Instalación en Losa Gruesa  
para Montura de Bordes de  
Bañeras Romanas



**RP18367**  
Lower Body Shank - Roman Tub Deck  
Thick Tile Rough-In  
Ensamble de la Espiga del Cuerpo Inferior-  
Preparación de Instalación en Losa Gruesa  
para Montura de Bordes de  
Bañeras Romanas



**RP18368**  
Upper & Lower Body Assy. - Roman Tub  
Deck Thick Tile Rough-In  
Ensamble del Cuerpo Superior y Inferior-  
Preparación de Instalación en Losa  
Gruesa para Montura de Bordes de  
Bañeras Romanas

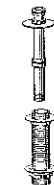

**RP18369**  
End Valve Assy. - Roman Tub  
Deck Conv. Rough-In  
Ensamble de la Válvula Final-Preparación  
de Instalación Convencional para Montura  
de Bordes de Bañeras Romanas



**RP18370**  
Nuts & Washers - Roman-Tub Deck Conv. Rough-In  
Tuercas y Arandelas-Preparación de Instalación  
Convencional para Montura  
de Bordes de  
Bañeras Romanas



**RP18371** - See/Ver RP18543

**RP18372**  
Handle-Clear Knob-Large-RT Deck/RT Hand Shower  
Manija-Perilla de Transparente-Grande-  
Bañera Romana-RT Regadera de Mano



**RP18373, RP18373PB**  
Button Set-Clear Wave-Red/Blue-2H Knob-1 1/2" Dia.  
Botones-Dibujo de Transparente-Rojo/Azul-  
2H Perilla-1 1/2" Dia.



**RP18393\*** - See/Ver H31 or H41

**RP18394**  
Adapter w/O-Ring - 2714  
Adaptador con Anillo "O"-2714



**RP18395**  
Set Screw/Tornillo de Ajuste - 2710/2730/2780



**RP18396, RP18396AB, RP18396PB**  
Spout Assy.-2714  
Ensamble del Tubo de Salida-2714



**RP18417, RP18417AB, RP18417AL, RP18417CB, RP18417PB, RP18417SB\*, RP18417WH**  
Spout Assy.-3543/3544/3545  
Ensamble del Tubo de Salida-  
3543/3544/3545



**RP18418**  
Base Plate/Placa - 2708/3543/3544/3545



**RP18423**  
Spout Assy.-2708  
Ensamble del Tubo de Salida-2708

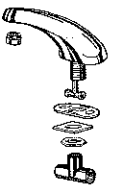

**RP18429**  
**RP18429PB** (for antique & polished brass/para bronce  
antiguo y pulido)  
Arrow Button-RT Hand Shower-1 1/2" Dia.  
Botón de Flecha-RT Regadera  
de Mano-1 1/2" Dia.



**RP18430\*, RP18430AL\*, RP18430WH\***  
Loop Handle w/Button & Set Screw-21460  
Manija con Argolla con Botón y Tornillo de Ajuste-  
21460

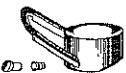

**RP18442**  
Arrow Button-Red/Blue-  
502/552/602/752/RP18860/RP21771-  
1 1/2" Dia.-Silver Insert  
Botón de Flecha-Rojo/Azul-  
502/552/602/752/RP18860/RP21771-  
1 1/2" Dia.-Botón de Plata



\*Check for inventory on discontinued parts. Vea el inventario para obtener piezas descontinuadas

**RP18454, RP18454PB**  
Aerator-NEO STYLE™ Kit/Lav-2.0 gpm @ 80 psi  
Aireador-NEO STYLE™ Coc/Lav-  
7.6L/Min @ 551 kPa



**RP18501** - See/Ver RP330

**RP18504**  
Thick Tile Mounting Kit-Roman Tub Deck Conv.  
Installation Kit-Adds 1" to End Valves  
Herramientas para Monturas en Losa Gruesa-  
Preparación de Instalación  
Convencional para Montura de Bordes  
de Bañeras Romanas-Válvulas Final  
para Más 1"



**RP18508, RP18508AL, RP18508PB, RP18508WH**  
Aerator w/Screen - Highrise Spouts -  
2.0 gpm @ 80 psi -15/16"-27 Male Thread  
Aireador con Rejilla-Tubo de Salida Alto-  
7.6L/Min @ 551 kPa-15/16"-27 Rosca Macho



**RP18543, RP18543AB, RP18543AL, RP18543PB,  
RP18543SB\*, RP18543WH**  
Base w/Gasket-3" Dia.-2710/2780  
Base con Empaque-3" Dia.-2710/2780

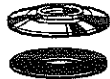

**RP18585**  
Mounting Hardware-for One End Valve of RP18235  
Herramientas para Montaje-para  
Válvula de Una Punta de RP18235



**RP18627**  
Extender/Extension - 2/3H T/S



**RP18629, RP18629AB, RP18629AL,  
RP18629PB, RP18629WH**  
Handle Assy.-1500  
Ensamble de Manija-1500



**RP18632, RP18632AL,  
RP18632PB** (for antique & polished  
brass/para bronce antiguo y pulido),  
**RP18632WH**  
Transfer Valve-RT Hand Shower-3" Base  
Válvula de Direccional-RT Regadera de  
Mano-Base de 3"

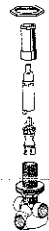

**RP18678**  
Knob/Ring Handle Screw - RT Hand Shower -  
10-24x3 1/2"  
Tornillo de Manija de Perilla/Anillo-RT  
Regadera de Mano -10-24x3 1/2"



**RP18724** (12 per case/12 por caja)  
Thin Wall 2/3H T/S Mounting Spacers-Bulk  
Pared Delgada 2/3H T/S Separadores para Montar-  
En Cantidades Grandes

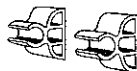

**RP18785**  
Vacuum Breaker Less Inlet Tubes-44  
Rompedor de Vacío sin  
Tubo de Entrada-44



**RP18841** - See/Ver RP10612

**RP18860**  
Handle w/Red-Blue Arrow Button & Screw-Single  
Knob Handle - 502/552/752  
Manija con Botón Flecha de Rojo/Azul y  
Tornillo-Manija Perilla Sólo-502/552/752



**RP18880\*, RP18880CB\*, RP18880CP\*, RP18880PB\***  
C-Spout Assy. - No Aerator - 3583/3584  
(or see RP21688)  
Ensamble del Tubo de Salida "C"-sin  
Aireador-3583/3584 (o ver RP21688)

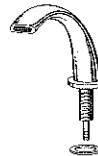

**RP18881\***  
Mounting Hardware - 3583/3584  
Equipo de Montura - 3583/3584



**RP18882, RP18882AL, RP18882PB, RP18882WH**  
Base & Gasket - 3583/3584  
Base y Empaque-3583/3584



**RP18908, RP18908AL, RP18908PB, RP18908WH**  
C-Spout Assy. - 2780  
Ensamble del Tubo de Salida  
en forma "C"-2780

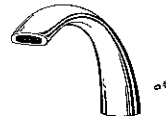

**RP18933, RP18933PB**  
Handle Conversion Kit-Small Levers-  
w/Aerator & Lift Knob  
Equipo de Conversión de Manija-Palancas de  
Pequeños-con Aireador y  
Barra de Alzar



**RP19082**  
Hose Assy.-5' Long-  
1/4" NPSM Female Swivel Nut-750/752  
Ensamble de Manguera-5' Largo-  
1/4" NPSM Tuerca Hembra Giratorio-750/752

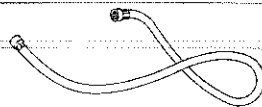

**RP19083**  
Spout w/5' Hose-  
1/4" NPSM Female Swivel Nut-750/752  
Salida con 5' Manguera-1/4" NPSM  
Tuerca de Hembra Giratorio-750/752

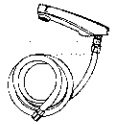

**RP19104**  
Extender Extensions (Extends RP18627 1")  
Extensiones (Extiende 1" RP18627)



**RP19105, RP19105PB**  
Top Mount Lever Handle Screws-(1" Longer than  
RP12630) - 10-24x5 3/8" - 2/3H T/S  
Tornillos de Montura Palanca Superior-(1" Largo  
que RP12630) - 10-24x5 3/8" - 2/3H T/S



**RP19106**  
Knob Handle Screws-(1" Longer than RP12629) -  
10-24x5 3/8" - 2/3H T/S  
Tornillos de Perilla-(1" Largo que RP12629) -  
10-24x5 3/8" - 2/3H T/S

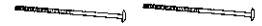

**RP19119, RP19119AB, RP19119PB**  
Undercover Plate-Brass-2H Lav Centerset  
Placa-Bronce-2H Lav Centro



**RP19138\***  
Gasket/Empaque - 130/430



**RP19156, RP19156AL, RP19156PB,  
RP19156SB** (for antique brass/para bronce antiguo),  
**RP19156WH**  
Sleeve Extenders-2/3H T/S-Adds 1"  
Extensiones de Manguito-  
2/3H T/S-Más 1"



**RP19221MBS** (60 per case/60 por caja)  
Spray Outlet-1/2 gpm Flow Control-  
Non VR - 15/16"-27 Male Thread  
Boca de Salida del Focciador-1/2 gpm Control de  
Flujo-No VR-15/16"-27 Rosca Macho



**RP19226, RP19226AB, RP19226AL,  
RP19226PB, RP19226WH**  
Nut-SHP Handle-1500  
Tuerca-Manija de SHP-1500



**RP19331, RP19331PB**  
Handle Conversion Kit-Small Rings-  
w/Aerator & Lift Knob  
Equipo de Conversión de Manija-  
Anillos Pequeños-con Aireador y  
Barra de Alzar



# Miscellaneous Parts/Piezas Misceláneas

**RP19332, RP19332PB**  
Handle Conversion Kit-Large Rings-  
w/Stream Straightener  
*Herramientas para Conversión de  
Manija-Anillos Grandes-con  
Enderezador del Chorro*

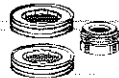

**RP19361**  
Spray Bracket-275 (Mfrd. After 3/93)  
*Soporte del Rociador-275  
(Fbdo. antes de 3/93)*

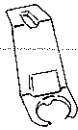

**RP19362** - Black w/Chrome Band/Negro con  
Anillo Cromo  
Spray & 30" Hose Assy. -  
1/4"-18 NPSM Female Swivel Nut -  
1/8" Female Stationary Nut Adapter - 275  
*Rociador y Ensamble de Manguera 30" -  
1/4"-18 NPSM Tuerca Giratoria  
Hembra - 1/8" Adaptador de Tuerca  
Fija Hembra-275*

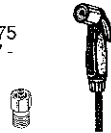

**RP19363**  
Cover Insert Assy.-200/275  
*Ensamble de Inserción para Tapa-  
200/275*



**RP19420**  
Gasket-2H Centerset Lav  
*Empaque-2H Lav Centro*

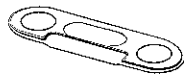

**RP19451**  
Nut/Tuerca - 560



**RP19452**  
Base, Nut & Gasket-560  
*Base, Tuerca y Empaque-560*

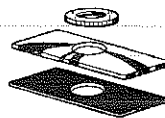

**RP19462, RP19462PB**  
Handle Conversion Kit-Large Levers-  
w/Stream Straightener  
*Herramientas para Conversión de  
Manija-Palanca Grandes-con  
Enderezador del Chorro*



**RP19464** - See/Ver A52CL  
**RP19464ABBRS** - See/Ver A72AB  
**RP19464AL** - See/Ver A72AL  
**RP19464BRS** - See/Ver A72  
**RP19464OAK** - See/Ver A72OK  
**RP19464PBBRS** - See/Ver A72PB  
**RP19464POR** - See/Ver A72PR  
**RP19464ROS** - See/Ver A72RS  
**RP19464SBBRS\***  
**RP19464WH** - See/Ver A72WH

**RP19465** - See/Ver A73  
**RP19465AB** - See/Ver A73AB  
**RP19465AL** - See/Ver A73AL  
**RP19465PB** - See/Ver A73PB  
**RP19465SB\***  
**RP19465WH** - See/Ver A73WH

**RP19466OAK** - See/Ver A73OK

**RP19467** - See/Ver A73ST

**RP19472\***  
Escutcheon/Chapetón - 460

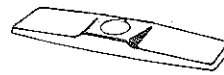

**RP19525, RP19525AL, RP19525PB, RP19525WH**  
Lift Rod Assy. for C-Spout Lav  
*Ensamble de Barra de Alzar para  
Fregaderos de Salida en forma "C"*



**RP19526** - See/Ver RP26533 & RP19525

**RP19530** - See/Ver H27  
**RP19530PB** - See/Ver H27PB

**RP19531** - See/Ver H67  
**RP19531PB** - See/Ver H67PB

**RP19532\*, RP19532PB\***  
Porcelain Cross Handle w/Screw & Wrench-  
Large-Arrow-3 1/4" Dia.-1600  
*Manija de Cruz de Porcelana con  
Tornillo y Llave-Grande-Flecha-  
3 1/4" Dia.-1600*

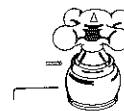

**RP19581PB**  
Tub Spout - Pull-Down Div. - Easy Slip-On - 1/2" CWT  
*Tubo de Salida-Desviador de Halar-  
Destice-1/2" CWT*

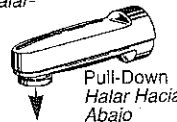

**RP19628** - See/Ver H77  
**RP19628PB** - See/Ver H77PB

**RP19652**  
Mounting Nuts & Washer-RT Hand Shower  
*Tuercas y Arandela Montura-RT Regadera de Mano*



**RP19653**  
Diverter Assy.-RT Hand Shower  
*Ensamble del Desviador-  
RT Regadera de Mano*



**RP19654, RP19654AL,**  
**RP19654PB** (for antique & polished brass/para bronce  
antiguo y pulido), **RP19654WH**  
Sleeve-RT Hand Shower  
*Manguito-RT Regadera de Mano*



**RP19655, RP19655AL, RP19655PB,**  
**RP19655SB** (for antique brass/para bronce antiguo),  
**RP19655WH**  
Screw-Lever/Cross Handle - 10-24x4 1/8" -  
RT Hand Shower  
*Tornillo-Manija Palanca/Cruz - 10-24x4 1/8" -  
RT Regadera de Mano*



**RP19656** - See/Ver H52  
**RP19656AB** - See/Ver H52AB  
**RP19656AL** - See/Ver H52AL  
**RP19656PB** - See/Ver H52PB  
**RP19656WH** - See/Ver H52WH

**RP19657CBBRS** - See/Ver H52 & A72PB

**RP19658** - See/Ver H53  
**RP19658AB** - See/Ver H53AB  
**RP19658AL** - See/Ver H53AL  
**RP19658PB** - See/Ver H53PB  
**RP19658SB\***  
**RP19658WH** - See/Ver H53WH

**RP19659**-Silver Insert/Botón de Plata  
**RP19659PB**-Gold Insert/Botón de Oro  
Button Set-Clear-2 Handle Knob-Red/Blue  
Indicator-1 5/16" Dia.  
*Botones-Transparente-2H Perilla-  
Indicadores Rojo/azul-1 5/16" Dia.*



**RP19660** - See/Ver H21  
**RP19660PB** - See/Ver H21PB

**RP19662\*** (or see RP14179/o ver RP14179)  
Body Gasket-21460  
*Empaque de Cuerpo-21460*



**RP19663BL\*, RP19663GR\***  
Sprayhead Cover, Support & Lever-21460  
*Tapa para Cabeza de Regadera,  
Soporte y Palanca-21460*



**RP19664\*, RP19664AL\*, RP19664WH\***  
Spray Head Assy.-21460  
*Ensamble de Cabeza de  
Regadera-21460*

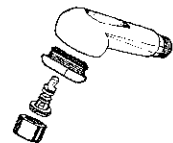

**RP19666\*, RP19666AL\*, RP19666WH\***  
Aerator (M22-1) Metric-21460  
*Aireador (M22-1) Métrico-21460*



**RP19667\***  
Swivel Stop-21460  
*Tope Giratorio-21460*



**RP19668\***  
Hose Assy.-59" Long-Metric Female End-21460  
*Ensamble de Manguera-59"  
Largo-Final Hembra-21460*



**RP19669\***  
Spray Head Check Valve-21460  
*Válvula de Control del Cabeza de  
Rociador-21460*



**RP19670\***  
Gasket/Empaque - 21460



\* Check for inventory on discontinued parts. *Vea el inventario para obtener piezas discontinuadas.*

**RP19676**  
Bracket w/Screws-Brass-Mounting-Diagonal Esc.  
Screw Holes-1300/1400/1500  
Soporte con Tornillos-Bronce-  
Montura-Huecos para los Tornillos  
Diagonal-1300/1400/1500

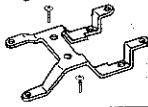

**RP19749** - See/Ver H57  
**RP19749PB** - See/Ver H57PB

**RP19750** - See/Ver H17  
**RP19750PB** - See/Ver H17PB

**RP19754**  
Aerator - 1.5 gpm @ 80 psi - 15/16"-27 Male Thread  
Aireador - 5.7L/Min @ 551 kPa -  
15/16"-27 Rosca Macho



**RP19802, RP19802AB, RP19802AL,**  
**RP19802PB, RP19802WH**  
Escutcheon-Push Button Diverter-  
Diagonal Esc. Screw Holes-1300/1400  
Chapetón-Desviador del Botón Pulsador-  
Huecos para los Tornillos Diagonal-  
1300/1400



**RP19804**  
Cartridge Assy.-SS Plate-1300/1400  
Ensamble del Cartucho-  
Placa de Acero Inoxidable-  
1300/1400

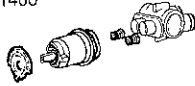

**RP19805**  
Lower Housing Assy. of RP19804 Cartridge  
Ensamble de la Conexión de Entrada  
Inferior de RP19804 Cartucho

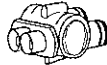

**RP19806**  
Upper Cap of RP19804 Cartridge  
Tapa Superior de RP19804 Cartucho



**RP19807**  
Rotational Limit Stop-1300/1400  
Tope para Limitar-1300/1400



**RP19809, RP19809AB, RP19809AL,**  
**RP19809PB, RP19809SB\*, RP19809WH**  
Escutcheon-Diagonal Esc. Screw Holes-  
1300/1400  
Chapetón-Chapeton Diagonal-1300/1400



**RP19810** - See/Ver RP19809



**RP19811\*** - See/Ver RP22737

**RP19817** - See/Ver H75  
**RP19817AC** - See/Ver H75AC  
**RP19817AP** - See/Ver H75AP  
**RP19817CA** - See/Ver H75CA  
**RP19817CB** - See/Ver H75CB  
**RP19817CW** - See/Ver H75CW  
**RP19817OAK** - See/Ver H75CK  
**RP19817PA** - See/Ver H75PA  
**RP19817PB** - See/Ver H75PB  
**RP19817PBOAK** - See/Ver H75PK  
**RP19817PW** - See/Ver H75PW  
**RP19817WC** - See/Ver H75WC  
**RP19817WP** - See/Ver H75WP

**RP19820**  
Tub Spout - Pull-Up Div. - Easy Slip-On -  
Non-Metallic - 1/2" CWT  
Tubo de Salida para Bañera-  
Botón Desviador de Alzar-  
No Metálico-1/2" CWT

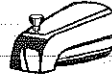

**RP19894, RP19894PB, RP19894SB\***  
Nut-LHP Handle-Roman Tub  
Tuerca-Manija de LHP-RT



**RP19895\***  
Tub Spout - Pull-Up Diverter - 1/2" IPS  
Tubo de Salida para Bañera-  
Botón Desviador de Alzar-1/2" IPS

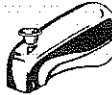

**RP19897**  
Spray Outlet - Laminar Flow - Non VR -  
2.0 gpm @ 80 psi - 15/16"-27 Male Thread  
Tubo de Salida del Rociador-Flujo Laminar-  
No VR-7.6L/Min @ 551 kPa -  
15/16"-27 Rosca Macho



**RP20032**  
Brass Pipe Plug-1/2" CWT-T/S  
Tapón de Bronce de Tubería-  
1/2" CWT-T/S



**RP20049**  
Spout O-Ring - Thick - 2167/2467/2474  
Anillo "O" del Tubo de Salida-Grueso-  
2167/2467/2474



**RP20055**  
Base - 1H Basin/Slow-Close - 2" Dia. - No Collar  
Base-1H Lav/Cierre Lento-2" Dia.-No Collar



**RP20101, RP20101AB, RP20101AL,**  
**RP20101PB, RP20101WH**  
Escutcheon-Diagonal Esc.  
Screw Holes-1500  
Chapetón-Huecos para los Tornillos  
Diagonal-1500



**RP20102, RP20102AB, RP20102AL,**  
**RP20102PB, RP20102WH**  
Escutcheon-Push Button Diverter-  
Diagonal Esc. Screw Holes-1500  
Chapetón-Desviador del Botón  
Pulsador-Huecos para los Tornillos  
Diagonal-1500



**RP20111**  
SS Conversion Ball-Knob to Lever  
Bola de Conversión de Acero  
Inoxidable-Cambia de Perilla a Manija  
de Palanca



**RP20140AL, RP20140WH**  
Vol. Control Handle Assy.-1500  
Ensamble de Manija Control  
Volumen-1500



**RP20184**  
Retention Screws - 10-24x3"  
Tornillos de Retención - 10-24x3"



**RP20185**  
Retention Screws - 10-24x1/2"  
Tornillos de Retención - 10-24x1/2"



**RP20229** - See/Ver H78

**RP20368**  
Handle Base Gasket-2767/2770  
Empaque de Base Manija-2767/2770

**RP20382** - See H55  
**RP20382AC** - See H55AC  
**RP20382AP** - See H55AP  
**RP20382CB** - See H55CB  
**RP20382CW** - See H55CW  
**RP20382OAK** - See H55CK  
**RP20382PB** - See H55PB  
**RP20382PBOAK** - See H55PK  
**RP20382PW** - See H55PW  
**RP20382WC** - See H55WC  
**RP20382WP** - See H55WP

**RP20383** - See H56  
**RP20383AC** - See H56AC  
**RP20383AP** - See H56AP  
**RP20383CB** - See H56CB  
**RP20383PB** - See H56PB  
**RP20383WC** - See H56WC  
**RP20383WP** - See H56WP

**RP20390**  
Gasket/Empaque - 100/400



**RP20458**  
Wrench-5/64" Allen  
Llave-5/64" Allen



**RP20461** - See/Ver H36  
**RP20461AC** - See/Ver H36AC  
**RP20461AP** - See/Ver H36AP  
**RP20461CB** - See/Ver H36CB  
**RP20461PB** - See/Ver H36PB  
**RP20461WC** - See/Ver H36WC  
**RP20461WP** - See/Ver H36WP

**RP20537**-Silver Insert/Botón de Plata  
**RP20537PB**-Gold Insert/Botón de Oro  
Arrow Button-1 5/16" Dia.  
Botón de Flecha-1 5/16" Dia.



**RP20542**-Silver Insert/Botón de Plata  
**RP20542PB**-Gold Insert/Botón de Oro  
Arrow Button-Red/Blue Indicators-  
1 1/2" Dia.-1300/1400/1600  
Botón de Flecha-Indicadores Rojo/Azul-1 1/2" Dia.-  
1300/1400/1600



# Miscellaneous Parts/Piezas Misceláneas

**RP20587**  
Bonnet Removal Wrench-(RP50 w/Knurris)  
Llave para Sacar Capuchones-  
(RP50 con Estrías)



**RP20605**  
**RP20605SB** (for antique & polished brass/para bronce antiguo y pulido)  
Handle & O-Ring for RP6152/RP6218  
Manija y Anillo "O" para  
RP6152/RP6218



**RP20665**  
Spout Assy. w/VR Aerator & Wrench-3501/3509  
Ensamble del Tubo de Salida con Aireador de Resistente al Maltrato y Llave-3501/3509



**RP20666**  
Spout Assy. w/VR 1/2 GPM Spray Outlet & Wrench  
Ensamble del Tubo de Salida con Boca de Salida del Rociador de VR 1.9L/Min y Llave

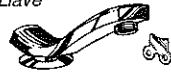

**RP20667**  
Spout Assy. w/VR Aerator & Wrench-3541  
Ensamble del Tubo de Salida con Aireador de Resistente al Maltrato y Llave-3541



**RP20668**  
Spout Assy. w/VR Aerator & Wrench-3548/3549  
Ensamble del Tubo de Salida con Aireador de Resistente al Maltrato y Llave-3548/3549



**RP20669**  
Spout Assy. w/VR 1/2 gpm Spray Outlet & Wrench-3551  
Ensamble del Tubo de Salida con Boca de Salida del Rociador de VR 1/2 gpm y Llave



**RP20781\*** - See/Ver RP22659

**RP20782**  
Gasket-White-2167/2467  
Empaque-Blanco-2167/2467

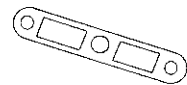

**RP20818** - See/Ver H51  
**RP20818PB** - See/Ver H51PB

**RP20902, RP20902AL, RP20902PB, RP20902WH**  
Escutcheon/Chapetón - 2177

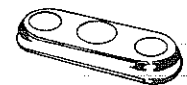

**RP20903, RP20903PB**  
Spout Tip & Gasket-2767/2768  
Pico del Tubo de Salida con Empaque-2767/2768



**RP20909, RP20909PB**  
Spout Trim Ring-2177  
Anillo de Guarnición para el Tubo de Salida-2177



**RP20943\*** - See/Ver RP22659

**RP20944**  
Gasket-Almond-2167/2467  
Empaque-Almendra-2167/2467

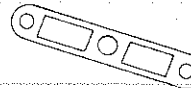

**RP20996**  
Aerator w/Screen - VR w/Wrench - 55/64"-27 Male Thread - 2.0 gpm @ 80 psi  
Aireador con Rejilla - VR con Llave de Tuercas - 55/64"-27 Rosca Macho - 7.6L/Min @ 551 kPa



**RP21049, RP21049PB**  
Lift Rod - LHP - C-Spout  
Barra de Alzar-LHP-Tubo de Salida en forma "C"



**RP21461**  
Gasket-2H Kitchen (except 2167/2467)  
Empaque-2H Cocina (excepto 2167/2467)



**RP21462, RP21462AL, RP21462CB, RP21462PB, RP21462WH**  
Spout w/Aerator-9 1/2" Long  
Tubo de Salida con Aireador-9 1/2" Largo

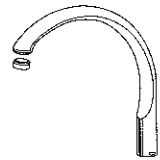

**RP21463**  
Spout Retainer-Waterfall® Kitchen  
Retención del Tubo de Salida-Waterfall® Cocina



**RP21464, RP21464AL, RP21464PB, RP21464WH**  
Spout Bonnet-172/173/174  
Bonete de Tubo de Salida-172/173/174



**RP21465** - See/Ver RP25056

**RP21466** - See/Ver RP25056

**RP21467** - See/Ver RP25057

**RP21468** - See/Ver RP25057

**RP21469, RP21469AL, RP21469PB, RP21469WH**  
Lever Handle w/Set Screw-172/173/174  
Palanca con Tornillo de Ajuste-172/173/174



**RP21516**  
Mounting Kit-W/S C-Spout Lav w/Aerator for RP21688  
Equipo de Montura-W/S Lav del Tubo de Salida en Forma C con Aireador para RP21688



**RP21533, RP21533AL, RP21533WH**  
Lever Handle w/Red-Blue Button & Screw-462  
Palanca con Botón Rojo/Azul y Tornillo-462



**RP21534**  
Red/Blue Button-1H Kitchen  
Botón Rojo/Azul-1H Cocina



**RP21535**  
O-Rings - Spout Body - 462/466  
Anillos "O"-Cuerpo del Tubo de Salida-462/466



**RP21536, RP21536AL, RP21536CW, RP21536WH**  
Hub Assy.-462/466  
Ensamble del Cubo-462/466

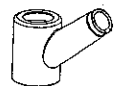

**RP21537**  
Gasket-Clear-462/466  
Empaque-Transparente-462/466

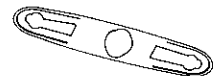

**RP21538, RP21538AL, RP21538WH**  
Base-Single Hole Mount-462/466  
Base-Montura de un Hueco-462/466



**RP21539**  
Adapter w/Flow Control-462/466  
Adaptador con Control de Flujo-462/466



**RP21540**  
Hose Washer-Small-462/466  
Arandela para Manguera-Pequeña-462/466



**RP21541**  
Hose Assy. w/Washers-59"-462/466  
Ensamble de la Manguera con Arandelas-59"-462/466

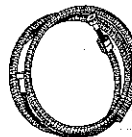

**RP21542**  
Hose Washer-Large-462/466  
Arandela de Manguera-Grande-462/466



**RP21543, RP21543AL, RP21543WH**  
Aerator w/Screen - 462/466 - 55/64"-27 Female Thread - 2.0 gpm @ 80 psi  
Aireador - 462/466 - 55/64"-27 Rosca Hembra - 7.6L/Min @ 551 kPa



**RP21544, RP21544AL, RP21544CW, RP21544WH**  
Spray Face Assy.-462/466  
Ensamble de la Cara del Rociador-462/466

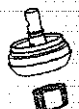

\* Check for inventory on discontinued parts. Vea el inventario para obtener piezas descontinuadas.

**RP21545AL, RP21545GR, RP21545WH**  
Cover, Support & Lever-462/466  
*Tapa, Soporte y Palanca-462/466*



**RP21546**  
Hose Adapter w/Check Valve Assy.-462/466  
*Adaptador de Manguera con Ensamble de la Válvula de Control-462/466*



**RP21547, RP21547AL, RP21547CW, RP21547WH**  
Spout Assy.-462/466  
*Ensamble del Tubo de Salida-462/466*



**RP21551, RP21551AL, RP21551PB, RP21551WH**  
Escutcheon/Chapetón - 150/450

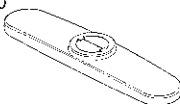

**RP21558, RP21558AL, RP21558PB, RP21558WH**  
Escutcheon/Chapetón - 350

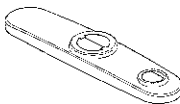

**RP21598**  
Diverter w/Tougher Tan Seal-3H T/S (cast brass models only)  
*Desviador con Sello Más Fuerte, Color Canela-3H T/S (Sólo Modelos Bronce)*

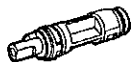

**RP21630, RP21630PB, RP21630WH**  
Escutcheon-HDF-Red/Blue Label-Diagonal Esc. Screw Holes-1300/1400  
*Chapetón-HDF-Etiqueta Rojo/Azul-Chapetón Diagonal-1300/1400*



**RP21631**  
Escutcheon - Push-Button Div. - HDF - Diagonal Esc. Screw Holes-Red/Blue Label - 1300/1400  
*Chapetón-Desviador de Botón Pulsador-HDF-Chapetón Diagonal-Etiqueta Rojo/Azul-1300/1400*



**RP21633, RP21633AB, RP21633AL, RP21633PB, RP21633WH**  
Deep Escutcheon-1300/1400/1500-1" Deeper-Diagonal Esc. Screw Holes  
*Chapetón de Hondo-1300/1400/1500-1" Más Hondo-Huecos para los Tornillos Diagonal*



**RP21634, RP21634AB, RP21634AL, RP21634PB, RP21634WH**  
Deep Escutcheon-Push Button Div.-1" Deeper-1300/1400/1500  
*Chapetón de Hondo-Desviador de Botón Pulsador-1" Más Hondo-1300/1400/1500*



**RP21688, RP21688AL, RP21688AP, RP21688CB, RP21688CP, RP21688PB, RP21688WC, RP21688WH, RP21688WP**  
Spout Assy. w/Aerator-3583/3584  
*Ensamble del Tubo de Salida con Aireador-3583/3584*

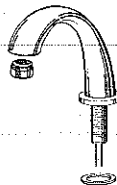

**RP21771**  
Handle w/Red-Blue Arrow Button & Screw  
*Manija con Botón de Flecha Rojo/Azul y Tornillo*

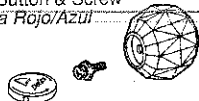

**RP21811, RP21811AL, RP21811PB, RP21811WH**  
Escutcheon/Chapetón - 2100/2102/2400/2402

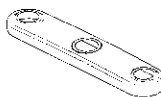

**RP21825, RP21825PB**  
Spout Bonnet - 2174/2176/2474/2476  
*Bonete del Tubo de Salida-2174/2176/2474/2476*



**RP21826, RP21826AL, RP21826PB, RP21826WH**  
Sleeve/Manguito - 172/173/174



**RP21874**  
Lever Handle-Red/Blue Indicators-1H Lav  
*Palanca-Indicadores Rojo/Azul-1H Lav*



**RP21904**  
Bottle-Soap/Lotion Dispenser-10 oz.  
*Botella-Surtidor de Jabón/Loción-10 oz.*

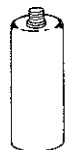

**RP21905, RP21905AL, RP21905PB, RP21905WH**  
Head-Soap/Lotion Dispenser  
*Cabeza-Surtidor de Jabón/Loción*

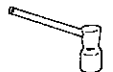

**RP21906, RP21906AL, RP21906PB, RP21906WH**  
Body-Soap/Lotion Dispenser  
*Cuerpo-Surtidor de Jabón/Loción*



**RP21907, RP21907AL, RP21907PB, RP21907WH**  
Base & Gasket-Soap/Lotion Dispenser  
*Base y Empaque-Surtidor de Jabón/Loción*



**RP21908**  
Pump-Soap/Lotion Dispenser  
*La Bomba-Surtidor de Jabón/Loción*



**RP21934**  
Mounting Nut, Washer & Locknut - 100-D/350/400-D  
*Tuerca de Montura, Arandela y Contratuerca - 100-D/350/400-D*



**RP21945**  
Nut-Soap/Lotion Dispenser  
*Tuerca-Surtidor de Jabón/Loción*



**RP21962, RP21962AC, RP21962AP, RP21962CB, RP21962PB, RP21962WC, RP21962WP**  
Spout Assy.-8 1/2" Long-2167/2467  
*Ensamble del Tubo de Salida-8 1/2" Largo-2167/2467*



**RP21963**  
Spout Bushing - 2147/2170/2171/2172/2447  
*Buje del Tubo de Salida-2147/2170/2171/2172/2447*



**RP21965\***  
Spout Assy.-9 1/2" Long-2474  
*Ensamble del Tubo de Salida-9 1/2" Largo-2474*



**RP21966**  
Laminar Flow Spray Outlet - VR - w/Wrench - 2.0 gpm @ 80 psi - 55/64"-27 Female Thread - 15/16"-27 Male Thread  
*Boca de Salida del Rociador - VR - con Llave - 7.6L/Min @ 551 kPa - 55/64"-27 Rosca Hembra - 15/16"-27 Rosca Macho*



**RP21969, RP21969AC, RP21969AP, RP21969CB, RP21969PB, RP21969WC, RP21969WP**  
Spout Assy.-2567  
*Ensamble del Tubo de Salida-2567*

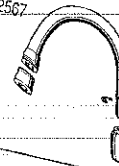

**RP22000AL, RP22000WH**  
Spray & 4" Hose Assy. - 1/4"-18 NPSM Female Swivel Nut-Gourmet™/Waterfall™ Kitchen Rociador y Ensamble de la Manguera de 4" - 1/4"-18 NPSM Tuerca Giratoria Hembra-Gourmet™/Waterfall™ Cocina

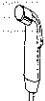



# Miscellaneous Parts/Piezas Misceláneas

**RP22004**  
Spout Assy. w/VR Aerator & Wrench - 2171-HDF  
Ensamble del Tubo de Salida con  
Aireador de Resistente al Maltrato y  
Llave - 2171-HDF



**RP22119, RP22119AL, RP22119WH**  
Escutcheon/Chapetón - 462/466

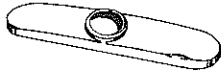

**RP22132**  
Helpful Hand Installation Aid - 4"-16" Widespread -  
Holds & Aligns Handles  
Utensilio para Asistencia en Instalaciones a Mano -  
4"-16" W/S - Sujeta y Alinea las Manijas

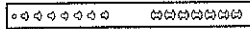

**RP22166, RP22166AL, RP22166PB, RP22166WH**  
Lever Handle w/Set Screw Gourmet™  
Palanca con Tornillo de Ajuste-  
Gourmet™



**RP22167, RP22167AL, RP22167PB, RP22167WH**  
Spout-Gourmet™  
Tubo de Salida-Gourmet™

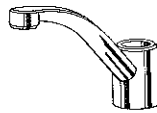

**RP22168**  
Spout Hub Liner-Gourmet™  
Separador para el Tubo de Salida-  
Gourmet™



**RP22170, RP22170AL, RP22170PB, RP22170WH**  
Spray Nest-350  
Nido del Focidador-350



**RP22187**  
Button-Red/Blue-Gourmet™  
Botón-Rojo/Azul-Gourmet™



**RP22199**  
Gaskets-Bidet  
Empaques-Bidet



**RP22200**  
Lever Handle Bands for RP11768HDF-Red/Blue  
Bandas para Palanca para RP11768HDF-  
Rojo/Azul



**RP22230**  
Mounting Bracket w/Screws -  
Non-Pressure Balance 600/1600  
Soporte para Montura con Tornillos -  
Sin Presión Balanceada 600/1600

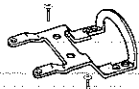

**RP22289**  
Mounting Nut & Washer - 100-D/400-D (after 3/94)  
Tuerca de Montura y Arandela -  
100-D/400-D (otro 3/94)



**RP22357**  
Escutcheon Seal-Center Hole-  
2.8" dia.-1300/1400/1500  
Sello de Chapetón-Hueco de  
Centro-2.8" dia.-1300/1400/1500



**RP22463** - See/Ver H78

**RP22542** - See/Ver H13

**RP22543** - See/Ver A13

**RP22544OAK** - See/Ver A13OK

**RP22545** - See/Ver A13ST

**RP22659**  
Undercover Plate/Placa - 2177/2567

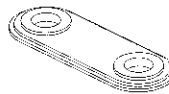

**RP22661, RP22661PB**  
Spout Trim Ring-2567  
Anillos de los Accesorios del Tubo  
de Salida-2567



**RP22663, RP22663PB**  
Spout Trim Ring-2177  
Anillos de los Accesorios del Tubo  
de Salida-2177



**RP22664AB, RP22664AL,  
RP22664PB, RP22664WH**  
Spout Bonnet-2177  
Bonete del Tubo de Salida-2177



**RP22734**  
Bonnet-Unplated-1300/1400/1500  
Bonete-Sin Acodado-1300/1400/1500



**RP22735, RP22735AB, RP22735AL,  
RP22735PB, RP22735WH**  
Trim Sleeve-1300/1400  
Manguito de Accesorio-1300/1400



**RP22736, RP22736AB, RP22736AL,  
RP22736PB, RP22736WH**  
Trim Sleeve-1500  
Manguito de Accesorio-1500



**RP22737, RP22737AB, RP22737AL,  
RP22737PB, RP22737WH**  
Trim Sleeve, Bonnet & O-Ring - 1300/1400  
Manguito de Accesorio,  
Bonete y Anillo "O"-1300/1400

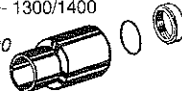

**RP22738, RP22738AB, RP22738AL,  
RP22738PB, RP22738WH**  
Trim Sleeve, Bonnet & O-Ring - 1500  
Manguito de Accesorio,  
Bonete y Anillo "O"-1500



**RP22808AL\*, RP22808WH\***  
Spout Assy. Less Hose-460/461  
Ensamble del Tubo de Salida  
Sin Manguera-460/461

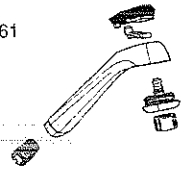

**RP22828**  
Horizontal Rod - 8 1/8" Long -  
Metal Pop-Up Drain Assy.  
Barra Horizontal-8 1/8" de Largo-  
Ensamble del Desaghe Automático  
de Metal

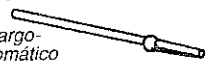

**RP22934**  
Spout O-Rings - Waterfall® Kitchen  
Anillos "O" de Salida-Waterfall® Cocina



**RP22967**  
Spray Head Only-Black w/Chrome Band  
Sólo Cabeza de Focidador-Negro con Anillo  
Cromo



**RP23060, RP23060AB, RP23060AL,  
RP23060PB, RP23060WH**  
Drain Flange - Metal Pop-Up Drain Assy.  
Brida de Drenaje-Ensamble de Desaghe  
Automático de Metal



**RP23061**  
Drain Body - Metal Pop-Up Drain Assy.  
Cuerpo de Drenaje-Ensamble de Desaghe  
Automático de Metal



**RP23062**  
Grid Flange for RP6346  
Brida de Rejilla para RP6346



**RP23063**  
Drain Body-No Horizontal  
Rod/Pivot Hole for RP6346/RP6339  
Cuerpo de Drenaje-No Horizontal  
Barra/Hoyo del Pivote para  
RP6346/RP6339



**RP23064**  
Rotary Stopper Flange for RP6339  
Brida del Tapón Giratorio para RP6339



**RP23075**  
O-Ring - Single Hole Mount Base - 462/466  
Anillo "O" - Base Montura de un Hueco-  
462/466



**RP23091, RP23091PB**  
Spout Assy. Less Stream Straightener-2770/2771  
Ensamble del Tubo de Salida sin  
Enderezador del Chorro-  
2770/2771

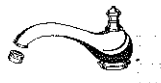

**RP23092, RP23092PB**  
Spout Base w/Gasket-2770/2771  
Base del Tubo de Salida con  
Empaque-2770/2771



\* Check for inventory on discontinued parts. Vea el inventario para obtener piezas descontinuadas.

See page 115 for abbreviations & suffixes.

**RP23093**  
Set Screw/Tornillo de Ajuste -  
1/4-28x7/16" - 2770/2771



**RP23094, RP23094AL, RP23094PB, RP23094WH**  
Scalloped Handle Base w/Gasket-  
2730/2731/2767/2768/2770/2771  
Base de Festón con Empaque-  
2730/2731/2767/2768/2770/2771

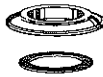

**RP23095, RP23095AL, RP23095PB, RP23095WH**  
Scalloped Handle Base w/Gasket-  
2147/2447/3530/3567/3577  
Base de Festón con Empaque-  
2147/2447/3530/3567/3577



**RP23096, RP23096PB**  
End Valve Assy. w/Fitting (1/2" IPS Male Adapter)-  
Scalloped Base-2147/2447/3567/3577  
Ensamble de la Válvula Final con Accesorios  
(Adaptador Macho IPS de 1/2")-Base de  
Festón-2147/2447/3567/3577

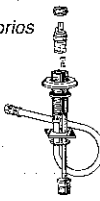

**RP23097, RP23097CB, RP23097PB**  
Spout Assy.-3577  
Ensamble del Tubo de Salida-3577



**RP23098, RP23098PB**  
Spout Base w/Gasket-3577  
Base del Tubo de Salida con Empaque-  
3577

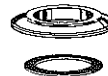

**RP23099** - See/Ver RP26533 & RP23103

**RP23101, RP23101PB**  
Spout Body-2447  
Cuerpo del Tubo de Salida-2447



**RP23102, RP23102PB**  
Spout Body-2147  
Cuerpo del Tubo de Salida-2147



**RP23103, RP23103PB**  
Lift Rod Assy.-3577  
Ensamble de Barra de Aizar-3577



**RP23104**  
Cap for Spout Body-2147  
Tapón para Cuerpo del Tubo de Salida-  
2147



**RP23105**  
Spout Adapter-2147/2447  
Adaptador del Tubo de Salida-2147/2447



**RP23336**  
Body O-Ring - 1300/1400/1500  
Anillo "O" de Cuerpo-1300/1400/1500



**RP23357**  
Upper Cap O-Ring - 1300/1400  
Anillo "O" de Tapon Superior-1300/1400



**RP23489**  
Plumbers Hook - Seat, Spring &  
Spout O-Ring Removal Tool  
Gancho de Plomero-Asiento,  
Resorte y Herr. para Sacar Anillo  
"O" del Tubo de Salida

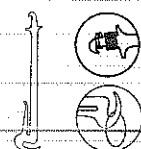

**RP23495** - See/Ver H41

**RP23496** - See/Ver H48

**RP23497** - See/Ver H11

**RP23498**  
Clear Knob Handles w/Buttons & Screws-2H  
Manijas de Perilla Transparente con  
Botones y Tornillos-2H

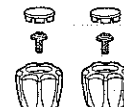

**RP23500**  
Anti-Seize Ring for RP50  
Anillo Antiaterrador para RP50



**RP23600** - See/Ver H73

**RP23608** - See/Ver H79

**RP23648** - See/Ver H31

**RP23700** - See/Ver H61

**RP23767**  
Escutcheon - 100-D/400-D  
(After 3/94 - See RP1065 before 3/94)  
Chapetón - 100-D/400-D  
(Después 3/94 -  
See RP1065 Antes 3/94)

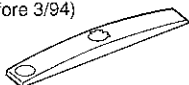

**RP23768**  
Base Plate - 100-D/400-D (After 3/94)  
Placa - 100-D/400-D (Después 3/94)

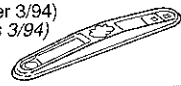

**RP23769**  
Spacer for Dispenser Body (Installs between  
escutcheon & base plate) -  
100-D/300-D/400-D (After 3/94)  
Separador para el Cuerpo del Surtidor  
(se instala entre el chapetón y la placa  
de base) - 100-D/300-D/400-D  
(Después 3/94)



**RP23770**  
Base Plate - 300-D (After 3/94)  
Placa - 300-D (Después 3/94)



**RP23771**  
Escutcheon - 300-D (After 3/94)  
Chapetón - 300-D (Después 3/94)



**RP23943, RP23943AC, RP23943AP, RP23943CB,  
RP23943PB, RP23943WC, RP23943WP**  
Spout w/O-Ring - 2767/2768  
Tubo de Salida con Anillo "O"-  
2767/2768



**RP23944, RP23944AL, RP23944PB, RP23944WH**  
Bonnet/Bonete - 2767/2768



**RP23945**  
Spout Snap Ring-2767/2768  
Aro de Resorte del Tubo de Salida-  
2767/2768



**RP23946**  
Spout Bonnet Gasket-2767/2768  
Chapetón de Bonete del Tubo  
de Salida-2767/2768



**RP23947, RP23947AC, RP23947AP, RP23947CB,  
RP23947WC, RP23947WP**  
Spout Assy.-2767/2768  
Ensamble del Tubo de Salida-  
2767/2768

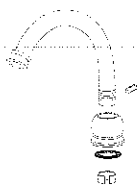

**RP24096**  
Stem Unit Assy.-Brass Stem-SS Plate  
Ensamble de la Unidad del Vástago-  
Vástago de Bronce-Placa de  
Acero Inoxidable



**RP24097**  
1/4 Turn Stop for RP24096 (Optional)  
Tope de Pare 1/4 para RP24096 (Opcional)



**RP24122PB**  
Lift Rod & Aerator Conversion Kit-Makes a Chrome  
Lav Faucet Chrome & Polished Brass  
Barra de Alzar con Equipo de Conversión del  
Aireador-Convierde Llaves de Lavamanos de  
Cromo a Llaves de Cromo y Bronce Pulido



**RP24588, RP24588PB**  
Lift Rod Finial for NEO STYLE™ Faucets  
Botón para la Barra del Desagüe para  
Llaves NEO STYLE™



**RP24649**  
Adapter w/O-Ring for Slip-On Diverter Tub Spouts  
Adaptador con Anillo "O"  
para del Tubo de Salida para  
Bañera Desviador



**RP24984**  
Vegetable Spray Hose Adapters  
Adaptadores para Manguera de  
Rociador de Vegetales



**RP25056, RP25056AL, RP25056PB, RP25056WH**  
Spout Body w/Base-172/173/174/2274  
Cuerpo del Tubo de Salida con Base-  
172/173/174/2274



# Miscellaneous Parts/Piezas Misceláneas

**RP25057, RP25057AL, RP25057PB, RP25057WH**  
Spout Body w/Base-2276  
Cuerpo del Tubo de Salida con Base-2276



**RP25423, RP25423AL, RP25423WH**  
Hose, Full Flow Aerator & Adapter w/Flow Control-462/466  
Manguera, Aireador de Flujo Completo y Adaptador con Control de Flujo-462/466



**RP25426, RP25426AL, RP25426WH**  
Adapter w/Flow Control & Full Flow Aerator-462/466  
Adaptador con Control de Flujo y Aireador de Flujo Completo-462/466

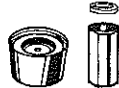

**RP25513**  
**RP25513MBS** (60 per case/60 por caja)  
Stem Unit Assy. w/Brass Stem-SS Plate & 1/4 Turn Stop-2H  
Ensamble de la Unidad del Vástago con Vástago de Bronce-Placa de Acero Inoxidable y Tope a un 1/4 de Rotación-2H



**RP25528, RP25528AL, RP25528PB, RP25528WH**  
Touch-Clean™ Showerhead-2.5 gpm @ 80 psi  
Cabeza de Regadera de Touch-Clean™-9.5L/Min @ 551 kPa



**RP25620**  
Set Screws for Small & Medium Side Mount Handles - 10-32x5/16" (Use 3/32 Allen Wrench)  
Tornillos de Ajuste para Manijas de Montura de Lado Pequeña y Mediana - 10-32x5/16" (Uso 3/32 Llaves de Allen)



**RP25804**  
Mounting Bracket Screws - 10-24x1/4" - 1H T/S Valves  
Tornillos de Montura Soporte - 10-24x1/4" - Válvulas de 1H T/S



**RP26139**  
Gasket/Empaque - 2530



**RP26140, RP26140AL, RP26140CB, RP26140PB, RP26140WH**  
Spout Assy. w/Aerator-4530  
Ensamble del Tubo de Salida con Aireador-4530

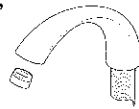

**RP26141, RP26141AL, RP26141CB, RP26141PB, RP26141WH**  
Spout Assy. w/Aerator-3530  
Ensamble del Tubo de Salida con Aireador-3530

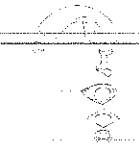

**RP26142**  
Spout Gasket-3530  
Empaque del Tubo de Salida-3530



**RP26143, RP26143AL, RP26143CB, RP26143PB, RP26143WH**  
Spout Assy.-2730/2731  
Ensamble del Tubo de Salida-2730/2731



**RP26146, RP26146AL, RP26146PB, RP26146WH**  
Handle Base, Snap Ring & Gasket-4530  
Base de Manija, Aro de Resorte y Empaque-4530



**RP26147, RP26147AL, RP26147PB, RP26147WH**  
Spout Base & Gasket-4530  
Base del Tubo de Salida y Empaque-4530



**RP26148, RP26148SB**  
Bonnet Nut - 4530  
Bonetes/Capuchones - 4530



**RP26149**  
Locknut/Contratuercas - 4530



**RP26150, RP26150AL, RP26150PB, RP26150WH**  
Lift Rod/Barra de Alzar - 4530-LHP



**RP26151, RP26151PB, RP26151WH**  
Lift Rod/Barra de Alzar - 4530



**RP26165, RP26165PB, RP26165WH**  
Lift Rod/Barra de Alzar - 2530/3530



**RP26232, RP26232AL, RP26232WH**  
Full-Flow Aerator - 55/64"-27 Female Thread - 462/466  
Aireador de Flujo Completo - 55/64"-27 Rosca Hembra - 462/466



**RP26533, RP26533AL, RP26533PB, RP26533WH**  
Metal Pop-Up Assy. Less Lift Rod  
Ensamble del Desagüe Automático de Metal Sin Barra de Alzar

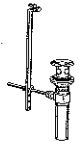

**RP26597**  
Lift Rod/Barra de Alzar - 4530



**RP26598**  
Lift Rod/Barra de Alzar - 4530



**RP26599, RP26599PB**  
Lift Rod/Barra de Alzar - 2530/3530



**RP26621, RP26621PB**  
End Valve Assy.-Scalloped Base-3530  
Ensamble de la Válvula Final-Base de Festón-3530



**RP26622, RP26622AL, RP26622PB, RP26622WH**  
End Valve Assy. w/Fitting (1/2" IPS Male Adapter)-Scalloped Base-3530  
Ensamble de la Válvula Final con Accesorios (Adaptador de 1/2" IPS Macho)-Base de Festón-3530



**RP26851, RP26851AB, RP26851AL, RP26851PB, RP26851WH**  
Spindle for H12/H22/H52/H62/H72  
Husillo para H12/H22/H52/H62/H72

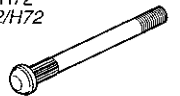

**RP26852, RP26852AL, RP26852PB, RP26852WH**  
Spindle for H14/H24/H54/H64/H74  
Husillo para H14/H24/H54/H64/H74

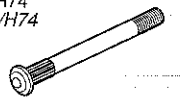

**RP26853**  
Allen Wrench for Side Mount Handles-3/32"  
Llave de Allen para Manija de Montura de Lado-3/32"



**RP26855**  
Nut & Washer  
Tuerca y Arandela

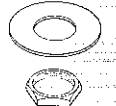

**RP26856**  
Retaining Ring  
Anillo de Retención



**RP26865**  
Set Screws for Large Side Mount Handles - 10-32x5/8" (Use 3/32" Allen Wrench)  
Tornillos de Ajuste para Manijas de Montura de Lado Grande-10-32x5/8" (Uso Llave de Allen 3/32")

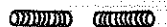

\* Check for inventory on discontinued parts. Vea el inventario para obtener piezas descontinuadas.

# Abbreviations & Suffixes

## Abbreviations

ADJ	Adjusting
ASSY	Assembly
BAL	Balance
BRS	Brass Lever Handles
COMP	Compression
CONV	Conventional
CWT	Copper Water Tube
D	W/Dispenser
DIA	Diameter
ESC	Escutcheon
GPM	Gallons Per Minute
H	Handle
HDF	Heavy Duty Faucet
ID	Inside Diameter
IPS	Iron Pipe Size
KIT	Kitchen
L	Liters
LAV	Lavatory
LHP	Less Handle Program
MB/MBS	Mini-Bulk
MFRD	Manufactured
NPSM	National Pipe Thread Straight Mechanical
NPT	National Pipe Thread Tapered
OAK	Oak
OD	Outside Diameter
OTR	Over-The-Rim Tub Spout (No Diverter)
POR	Porcelain
PRES	Pressure
PSI	Pounds Per Square Inch
RECT	Rectangular
ROS	Rosewood
RT	Roman Tub
SS	Stainless Steel
T/S	Tub/Shower
TEMP	Temperature
THD	Thread
VR	Vandal Resistant
W/	With
W/O	Without
W/S	Widespread
WF	With Fittings (1/2" IPS Adapters)
WS	With Screwdriver Stops

## Finishes

No Suffix	Chrome
AB	Antique Brass
AC	Almond/Chrome
AL	Almond
AP	Almond/Polished Brass
BL	Matte Black
CA	Chrome/Almond
CB	Chrome/Polished Brass
CK	Chrome/Oak
CL	Clear
CP	Polished Brass/Chrome
CW	Chrome/White
GR	Gray
MB	Matte Black
MP	Matte Black/Polished Brass
OK	Oak
PA	Polished Brass/Almond
PB	Polished Brass
PK	Polished Brass/Oak
PL	Polished Brass/Clear
PR	Porcelain
PW	Polished Brass/White
RD	Red
RS	Rosewood
SB	Satin Brass
ST	Soft Touch/Chrome Lift Rod Finial
STAB	Soft Touch/Antique Brass Lift Rod Finial
STAL	Soft Touch/Almond Lift Rod Finial
STPB	Soft Touch/Polished Brass Lift Rod Finial
STWH	Soft Touch/White Lift Rod Finial
WA	White/Almond
WB	See PW
WC	White/Chrome
WG	White/Gray
WH	White
WP	White/Polished Brass
WR	White/Red
WW	White/White
WW	White Wash



Delta Faucet Company  
A Division of Masco Corporation of Indiana  
55 East 111th Street, P.O. Box 40980  
Indianapolis, Indiana 46280  
Phone (317) 848-1812  
<http://www.deltafaucet.com>

©1996 Masco Corporation of Indiana